

1 9 9 5

F O U R W I N N I N G S









## Don't just buy a boat; buy a Four Winns. There's a difference...

In 21 years, Four Winns' reputation for quality and performance has made it one of the most sought after powerboat brands in the world. In 1995, 22 stunning models are wonderfully adapted to the needs of today's boating families. All are amply endowed with many of the comfort, convenience, security and technologically advanced features described over the next few pages. Please give as much attention to these pages as you do to Four Winns' product pages.

More than anything else, it is the level and variety of innovative features included on every model that separates a Four Winns from others vying for your attention...**Give your family our best!**

### AWARD-WINNING ALL STABLE-VEE® FLEET FOR 1995.

"1993 Popular  
Mechanics' Design  
and-Engineering  
Award Winner."



"1994 Stable-Vee  
210 Horizon:  
Powerboat magazine's  
Performance Run-  
about of the Year."



Four Winns' patented Stable-Vee design, now on every 1995 model, is perhaps the most significant running surface innovation since the inception of the deep-vee hull.

**A** Active pods aft of the transom on either side of the engine extend the running surface. They move the center of lift aft, acting like built-in trim tabs to limit bow rise, improve planing time, and allow



the boat to stay on plane at lower speeds - a plus when kneeboarding or tubing.

**B** A step in the hull at the transom allows the pods to run "dry" at higher speeds, for less drag and better top-end performance and operating efficiency.

**C** Stable-Vee's variable deadrise begins at the transom and increases very gradually to a point just forward of the helm, creating a large "footprint" in the water. Lateral stability, running or at rest, is better because Stable-Vee

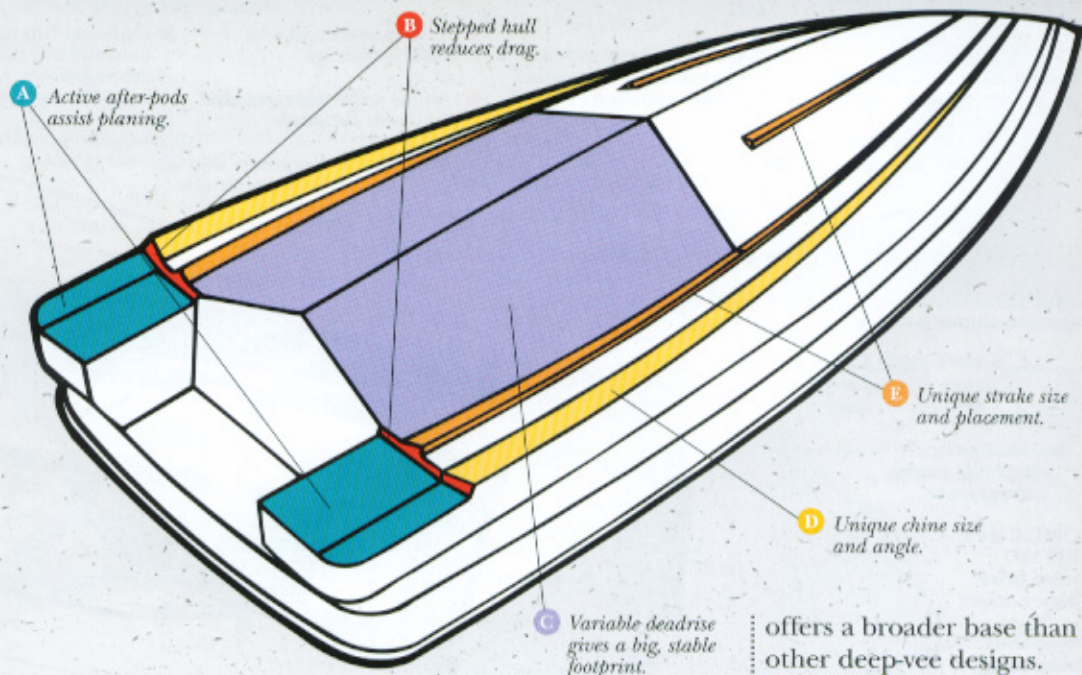

**A** Active after-pods assist planing.

**B** Stepped hull reduces drag.

**E** Unique strake size and placement.

**D** Unique chine size and angle.

**C** Variable deadrise gives a big, stable footprint.

offers a broader base than other deep-vee designs.

**D** The unique chine size and its reverse angle design help minimize spray, assist in planing, and contribute to lateral stability.

**E** Strake size and strategic placement contribute to performance by creating additional lift.

The overall effect of this exclusive combination of Stable-Vee design features is a boat that planes quickly, corners flat and predictably and provides great stability to impress and exhilarate experienced operators, while building confidence in those who are new at the helm.

### STABLE-VEE AND OMC COBRA EFI STERN DRIVE POWER...

...boating's best 1-2 performance punch. With 4 EFI engine choices in 1995, no other boat maker can offer more EFI opportunities than Four Winns. After 2 years EFI field experience in more than 2,500 Four Winns boats, the verdict is



in...carbureted stern drives simply can't match EFI for reliability, quick and sure startability (hot or cold), enhanced performance



through all operating ranges, plus improved fuel efficiency and emissions control.

A computer processor-based Spitfire™ electronic engine management system is the brains behind EFI sophistication and brawn. And dependable cone clutch power delivery provides smooth, quiet, positive shifting for every OMC Cobra stern drive.

(For the complete power story, please see page 48.)



## Four Winns quality, technology and value... an overview.

### FOUR WINNS QUALITY, TECHNOLOGY AND VALUE...IN DEPTH

All boating brochures dwell on their product's strong points. But often it's difficult just to sort out if the boats offer all the convenience, comfort, security and performance capabilities you're looking for, let alone the quality construction and leading edge technology so important to overall satisfaction and resale value. To render it a little easier to make those judgments about Four Winns, in the first 8 pages herein you'll find more than 30 major Four Winns advantages chronicled. These, we believe, represent the features predominantly responsible for the phenomenal acceptance of Four Winns around the world.



Designer Kelly Payne reviews a CAD image of a Four Winns hull.

- Award-winning all Stable-Vee® fleet
- Stain-shrugging, 45 gauge marine grade final finish vinyl by G&T, MSG
- Guaranteed-fresh Interstate, maintenance-free, deep-cycle battery
- In-floor ski locker with oversize opening and molded lid to accept kneeboards (Freedom/Horizon/Candia)
- Concealed Sunbrella top storage
- Engine mounted on glassed-in aluminum rails
- 100% OMC Cobra cone clutch power delivery systems
- OMC Spitfire™ electronic engine management
- OMC Cobra EFI V8 stern drive power teams
- 2-Year OMC Cobra stern drive owner protection
- Hidden engine vents
- Evinrude or Johnson outboard models available (Freedom/190 Horizon/200 Horizon/205 Sundowner)
- Full width non-skid swim platform w/port & starboard step-on area for easy access from the dock
- Adjustable port and starboard back-to-back folding loungers with kick-up headrest
- Quick-access padded engine box w/acoustical foam insulation
- 22 oz. cut pile carpeting by Carriage
- 3-tier sidewall storage
- Non-skid sidewall step pads
- Molded seats and seat bases w/storage
- Unique adjustable, molded, jump seat supports
- Premium, digital, 4-speaker audio system
- Passenger convenience center with integrated, overboard-draining cooler, removable tray, cutting board and glove box
- Optional flip-up cockpit convenience table with std. seating. Floor mount table available w/Sun Sport seating
- Wrap-around safety glass windshield with optional removable walk-through and, on Freedom and 190 Horizon, removable side panels
- Automotive-style, printed circuit instrumentation (except Fling, base Freedom, 278 Vista)
- Optional tilt steering wheel
- Emergency engine shut-off
- Concealed horn
- Wiring harness routed under the floor
- Fiberglass stringers (Fling/Freedom/190 Horizon)
- Closed cell foam flotation below the floor
- Interlocking floor system
- Rigid 5-stringer foundation (20' and above)
- Four Winns-manufactured Sure Load™ trailer custom designed to every model
- ABS chrome dimensional Four Winns logos
- In-floor, easy access molded fuel tank w/baffles for rigidity
- User-friendly, inclined, deep access stainless steel swim ladder w/foot rests and transom grab handle



- Bow area lounges (2) with contoured back rests (220/240 Horizon)

- Operator and passenger arm rests (200/220/240 Horizon, 195/205/225/245 Sundowner, Candia)

- Oversize beverage holders

- Welded stainless steel rails

- Fortified Attwood 316L stainless steel cleats and hardware is through-bolted & metal-backed

- Optional bow fill-in cushions (Fling/Freedom/Horizon/Candia)

- Hinged bow seat storage access (Horizon)

- Bow sidewall storage (240 Horizon)

- Cockpit courtesy lights, and passenger assist handles

- Molded anchor locker with cradle (20' and above)

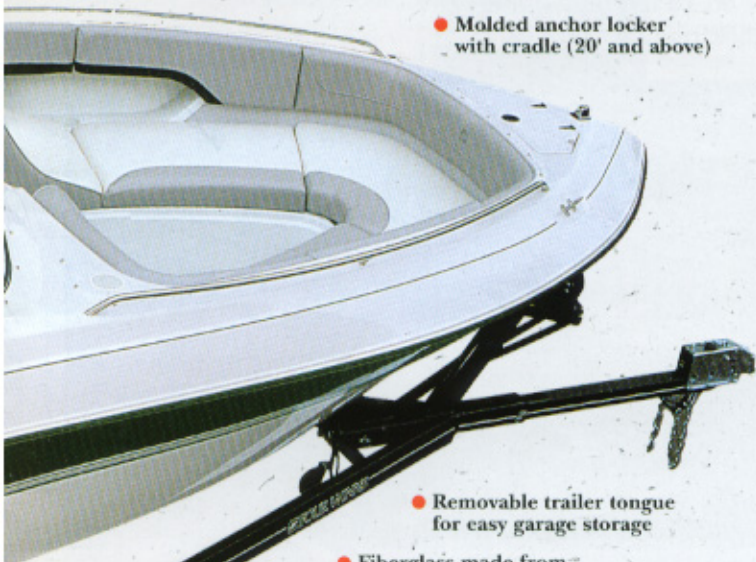

- Removable trailer tongue for easy garage storage

- Fiberglass made from low-styrene resin

- Transducer molded in hull simplifies installation of opt. Lowrance depth sounder, or fish finder

- Fade-fighting two-tone Armorcote finish (two-tone opt. Freedom, white only Fling)

- Winning Edge™ 5/2/1 Owner Protection on stern drive models. Ask your dealer for details.

- Color-coordinated UV-stable Sunbrella canvas on all models

- Water soluble glue used in tailoring of upholstery

## THE GREENING OF FOUR WINNS

Four Winns is constantly looking for ways to upgrade the processes and materials used to manufacture its boats. Today we use low styrene resin in the fiberglass and water soluble glue in tailoring the upholstery. Seats, seat bases and sidewall trim that were formerly wood are now molded. In many models, fiberglass stringer systems have replaced wood. And the optional Fireboy extinguishing system uses FE241, the only accepted halon alternative that is E.P.A. and U.S. Coast Guard approved.



Jim Crain applies 25 mils of Armorcote.



Resin-rich Armorcote



Typical gel coat

## FADE-FIGHTING ARMORCOTE™ FINISH

Four Winns protects your investment with a superior Armorcote finish on the deck and hull (some boat makers offer Armorcote only on decks). It's a premium, resin-rich finish, specially formulated to resist fading and yellowing, and retain more of its original gloss than even better grade gelcoats. With minimal care\*, you can expect your Four Winns to look as good in 3 years as it does at delivery. Please see page 53 for color availability by model.

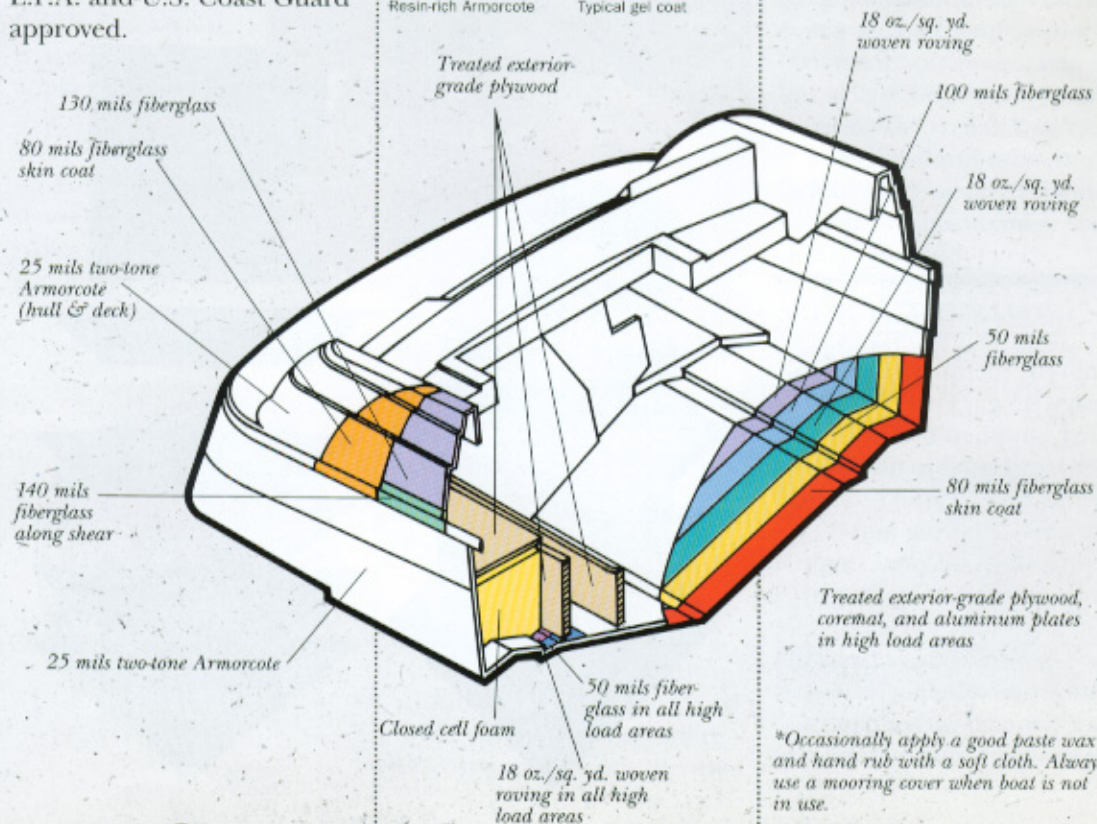

\*Occasionally apply a good paste wax and hand rub with a soft cloth. Always use a mooring cover when boat is not in use.





### UV-STABLE SUNBRELLA CANVAS

Four Winns uses only durable, beautiful, color-coordinated Sunbrella canvas with ultra-violet protection to enhance value and complement contemporary Four Winns styling. Factory-patterned tops with reinforced seams, large tooth nylon zippers and Velcro™ fasteners are custom-fitted to each model. *Please see page 53 for more information.*

### "INTELLIGENT" VINYL

Built-in "memory" lets the heavy, 45 ga. Final Finish vinyl, supplied by G&T MSG and used in all Four Winns boats, resist bunching and gathering and return to its original shape when depressed by foot or hand. It's easy to clean, fade- and stain-resistant, and protects against moisture damage with a patented Bio-Pruf mildew treat-

ment. It has a low-glare surface with a soft leather-like feel and appearance.



### UV-STABLE 22 Oz. CARPETING

Most boat carpeting looks nice when new. But traffic and spills take their toll. Four Winns installs only high grade 22 oz. carpeting by Carriage with stain-resistant Olefin fibers, fade-fighting, ultra-violet protection, and plush cut pile that returns to its full fresh appearance when vacuumed.

### PRINTED CIRCUIT INSTRUMENTS

All Four Winns models except Fling, the base Freedom, and the 278 Vista offer an exclusive Four Winns/OMC-designed instrument panel that features a full array of analog instruments integrated on a printed circuit board in place of individually-wired instruments.

Reliability and serviceability are major advantages. The unit has just 3 power connections, about 80% less than most marine instrument panels, and is housed in a smart, automotive-style shrouded dash that helps reduce glare. For servicing, the circuit board can be removed and replaced in under 3 minutes.



### TIDY WIRING HARNESS ROUTING

Reach up behind the coaming boards on Four Winns Horizon™ and Sundowner™ models...something's missing! Where's the spaghetti bundle of wire from the engine to the instrument panel that can come loose and hang down in an unsightly jumble, or worse, be pierced by an errant screw

through the coaming board, causing a short? Unlike others, Four Winns routes the wiring harness under the floor, through a PVC pipe, where it's protected and out of sight.





### BETTER FORTIFIED STAINLESS STEEL

Four Winns is a major exporter of boats to Europe where saline content is higher than North American coastal waters. We've adopted our stiffer export standards for stainless steel for use on models for this continent. The result is stainless steel that's better fortified against corrosion.

With a Four Winns as your family boat, you'll have peace of mind that the hard-

### THROUGH-BOLTED, METAL-BACKED HARDWARE

ware securing it to the dock...or holding the ski rope...or hooked to the straps lifting it out of the water is strong enough for the job. Four Winns cleats, ski eyes and

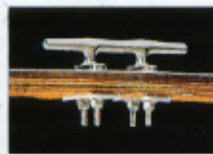

lifting eyes are through-bolted Attwood

316L stainless steel, cinched tightly to metal back plates.

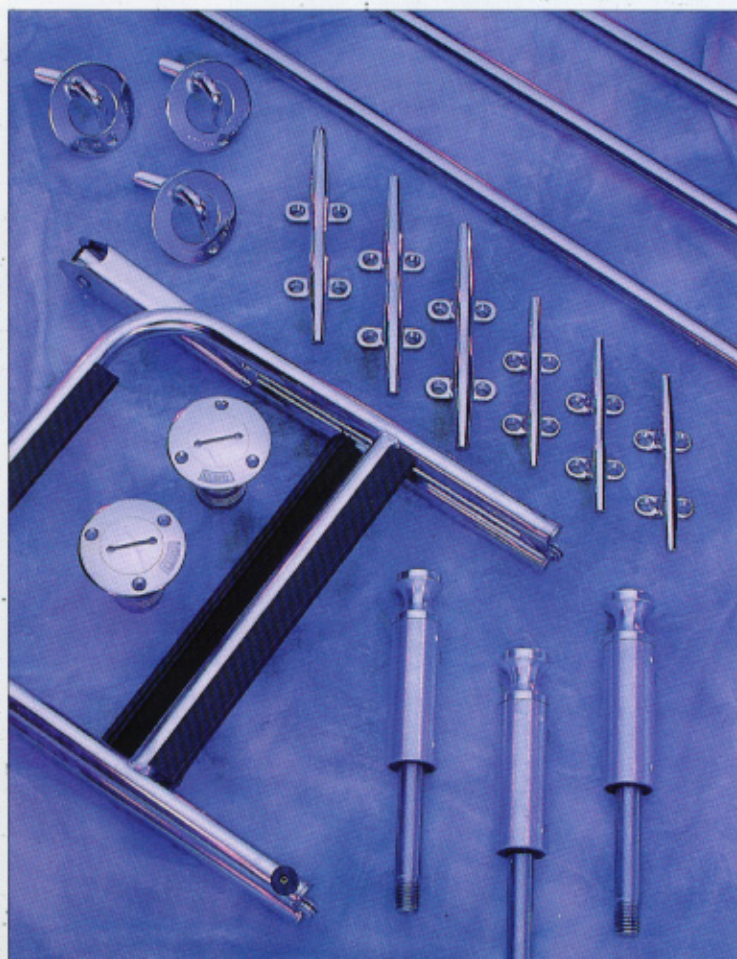

### EXCLUSIVE WINNING EDGE™ 5/2/1 OWNER PROTECTION...BOATING'S BEST COVERAGE

Four Winns helps you preserve your investment with a powerful owner protection plan that includes...a 5-year hull structural warranty...2-year protection on the OMC Cobra stern drive power team...and a 1-year limited warranty on factory-installed systems and components. Unused portions of *Winning Edge* 5/2/1 Owner Protection are transferable to subsequent owners. So you have peace of mind when you sell your boat...and so does the family that buys it. A 1-year transferable limited warranty applies on factory-rigged Evinrude® or Johnson® powered Four Winns boats and on Fling models, with extended coverage available. Ask your Four Winns Dealer for details.



### DURA-FRAME SEAT CONSTRUCTION

Four Winns' seat backs and seat rests are made of rugged injection-molded plastic that will not absorb moisture and deteriorate as wood seat components will over time. Multi-layers of mildew-resistant foam are added to the seats to provide comfort and support where they're needed most. Seats are then smartly tailored with triple-stitched, soft, low gloss custom-specified vinyl.



### ADJUSTABLE HEADREST ON FOLDING LOUNGERS

Some other boat brands are now adopting the Four Winns innovation that allows the fore or aft section of the seat to be raised like a deck chair when the seat is down, making it more comfortable and convenient for reading or conversation. On the star-

board lounger, the stern seat section can be raised. On the port side lounger, the forward section lifts. Moreover, both operator and passenger loungers adjust fore and aft.



### USER-FRIENDLY INCLINED SWIM LADDER

Entering most boats from deep water is difficult at best and often impossible for seniors or those with low arm strength. Four Winns' 3-step, stainless steel ladder has generous flat molded foot rests, and extends deep into the water. The ladder rests against the hull stern at an incline like a step ladder, allowing the legs to share in lifting the body out of the water. A convenient assist





handle through-bolted to the transom helps in boarding the full depth non-skid platform.

Entry from docks is easier too. The platform extends 6" behind the deck sidewall quarter panels, creating a barrier-free step area at platform level. Skiers use this feature too, setting their foot in the boot on the platform, as the ski rests over the step area with the skag hanging outside the boat.

#### FACTORY-PREPARED FOR DEPTH SOUNDER OR FISH FINDER

Every Four Winns except base Freedom and Fling includes a transducer molded flush with the bottom of the hull for more accurate reading. Others position the transducer to read through the hull which can be inaccurate, or mount it on the bottom and run wiring through the hull which may cause leaking. Wire leads to the instrument panel make it easy for factory or dealer installation of an optional Lowrance depth or fish finder.



Transducer is molded in.

#### A CUSTOM TRAILER FOR EVERY MODEL

Four Winns is one of a very few boat builders who manufacture their own trailers. Low-profile Four Winns Sure Load™ trailers are formed from heavy 11-gauge tubular steel, protected by two coats of color-matched, polyure-

thane baked enamel, (white on Fling) and custom-fitted to the boat hull. Trailers are optional on Vistas and standard on all other Four Winns models. A frame-mounted jack and a removable tongue make for easier maneuvering and storage. *Please see page 51 for more information.*



John Jaekel (left) and Ed Denman fabricate another Four Winns Sure Load trailer.

#### CONVENIENT, QUICK ENGINE ACCESS

On Freedom, Horizon™ and Sundowner™ models with standard interior, getting to the engine is easy. A hinged cover allows quick access to

add oil, monitor fluid levels, check condition of belts or perform other routine maintenance. For other engine service needs, four quick release bolts allow the entire engine box to be removed.



Quick engine access.

#### UNMATCHED SPORT BOAT STORAGE

Four Winns' reputation for cavernous storage is legendary. In Horizons and Sundowners 20' and over it reaches its zenith.

- 3-tier sidewall storage, running the full cockpit length gobbles up gear. (1) A large carpeted shelf inside the coaming boards keeps cam-

eras, handbags and billfolds dry and out of sight.

- (2) A lower carpeted shelf with ledge holds skis, light and canvas poles or other paraphernalia. (3) The floor area beneath the lower shelf stows shoes, paddle, gaff or other items that would otherwise clutter the cockpit.

- Under the cockpit floor, between the seats, a deep, long, carpeted-storage compartment is reached through a wide opening



Wide opening floor locker.

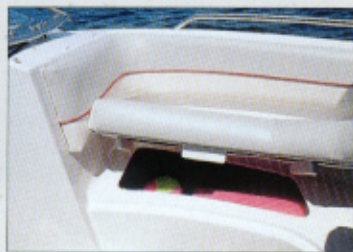

Storage under bow seats.

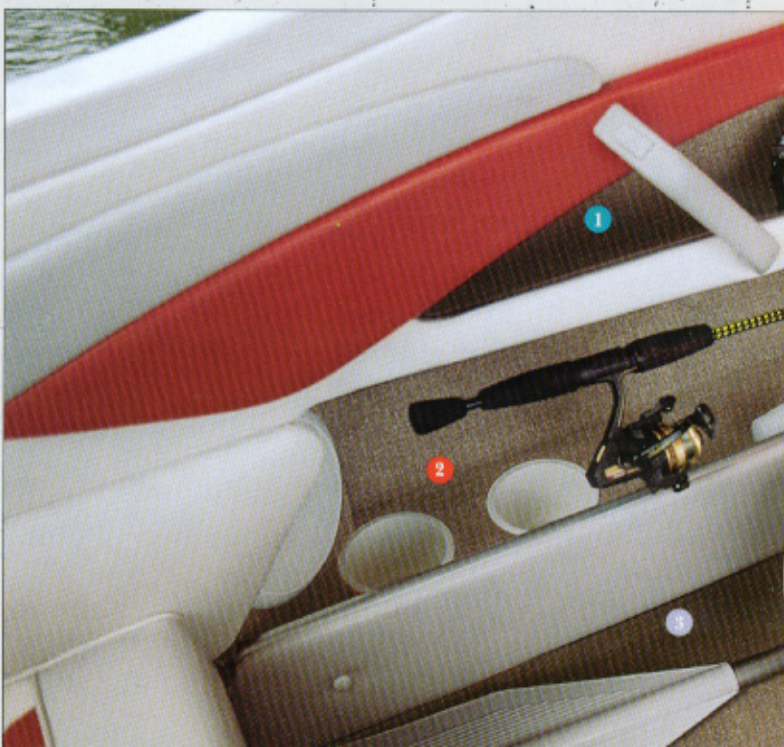



with molded lid that accepts kneeboards, skis and other outsized gear.

- In the bow area, under hinged seats, large storage bins hold PFDs, towels, dry clothing or whatever.
- An anchor locker (also on Vistas) features storage for 150' of line, a cradle to isolate the anchor from the fiberglass, a lid with line recesses, and a tie-off position inside the locker.
- A stern-width molded

storage area behind the engine compartment conceals the standard convertible top. Its padded, upholstered lid also hides the engine compartment air vent ducts on the transom.

- The port side passenger convenience console features a lockable glovebox and up to a 32-qt. integrated cooler with overboard drain. Inside, there's a removable fruit or sandwich tray. The cooler lid doubles as a cutting board.



Anchor locker w/anchor cradle.



Concealed top storage.

are armrests for the operator and passenger. The walk-through windshield can be removed and stored. Optional bow fill-in cushions convert the bow to a sun lounge. With standard seating, an optional flip-up table mounts on the front of the engine compartment. And with Sun Sport seating, an optional removable table can be mounted in the stern...or, on Horizon and Freedom, also in the bow.



Passenger armrest w/assist handle.

A molded step on the cabin bulkhead leads to a walk-through windshield. The non-skid deck is surrounded by a welded stainless steel bow rail.



### NEW STABILITY FOR JUMP SEATS

Movable stern jump seats on Horizons add convenience and versatility to the cockpit.



Jump seat supports lift & lock...

### MORE COCKPIT CONVENIENCE...

Generous storage is just one of many thoughtful Four Winns cockpit conveniences. Cockpit courtesy lights illuminate the floor. Numerous passenger assist handles are strategically placed. There

### MORE CONVENIENT CUDDY DECK ACCESS

On Four Winns 205/225/245 Sundowners and Vistas we've carefully thought out the deck access system to make it more convenient.



Opt. flip-up serving table.



...to reposition jump seat flush with the engine cover.

Our new jump seat support system provides more stability while eliminating the brackets that screw into the sidewall and engine box that can be a pain in the side or back for passengers. In seat configuration, the cushions are supported by molded struts that rest on the floor. To raise the seats flush with the engine cover for lounging, the struts lift, slide and lock securely in position.

### MAINTENANCE-FREE INTERSTATE BATTERIES ARE GUARANTEED FRESH

If a new boat sits in dealer inventory for several months, the startability of the battery may be questionable. Four Winns has an agreement with Interstate Batteries that takes care of that issue. When your dealer takes delivery of your new Four Winns boat, he'll install a reliable, fresh, maintenance-free, deep cycle, Interstate marine battery from his consigned inventory which is rotated every 90 days to assure battery freshness.











ANTRIM COUNTY'S  
GRASS RIVER  
NATURAL AREA  
PRESERVED FOR YOU  
PROTECT FOR OTHERS

**RULES**  
1. NO FEEDING OF WILDLIFE  
2. NO FEEDING OF DOMESTIC ANIMALS  
3. NO FEEDING OF FISH  
4. NO FEEDING OF BIRDS  
5. NO FEEDING OF BEES  
6. NO FEEDING OF INSECTS  
7. NO FEEDING OF MAMMALS  
8. NO FEEDING OF REPTILES  
9. NO FEEDING OF AMPHIBIANS  
10. NO FEEDING OF MOLLUSKS  
11. NO FEEDING OF CRUSTACEANS  
12. NO FEEDING OF PLANTS  
13. NO FEEDING OF FUNGI  
14. NO FEEDING OF BACTERIA  
15. NO FEEDING OF VIRUSES  
16. NO FEEDING OF PARASITES  
17. NO FEEDING OF PROTOZOANS  
18. NO FEEDING OF SPOROZOANS  
19. NO FEEDING OF METAZOANS  
20. NO FEEDING OF EUKARYOTES







190 HORIZON

FOUR WINNS 













FOUR WINNS

2001 LUNAR

11

2001 LUNAR













FOUR WINNS

175 SURFMASTER

17





Johnson

FOUR WINNS

205 SARDINER

FOUR WINNS















238 Vista

FOUR WINNS











# OMC Power and Four Winns Stable-Vee® hull...boating's best performance package.

For 1995, Four Winns and OMC offer a full range of outstanding power alternatives that are design-matched to the Four Winns Stable-Vee hull. OMC Cobra® continues to lead the way in stern drive technology with four models offering electronic fuel injection, smooth, quiet cone clutch shifting, and the exclusive Spitfire™ electronic engine management system. A 7.4L EFI V8 is new for 1995. Four Winns outboard models are powered by Evinrude® or Johnson®, the best-known, best-selling brands in the world. The 90SL and 115SL outboards are new state-of-the-art models this year. Fling is powered by a 115-hp oil-injected OMC TurboJet™ jet drive system.

- Smooth, quiet, uninterrupted cone clutch shifting
- Multi-port electronic fuel injection
- Spitfire™ micro-processor-driven electronic engine management
- Directly connected remote cable
- Standard counter rotation
- Standard power steering
- Forged, pattern-matched spiral bevel gears
- Hardened alloy steel drive shaft
- 13-step Deep Guard corrosion protection
- Corrosion fighting sacrificial anodes
- Floating coupler shaft
- Vertical drive components submerged in circulating oil bath

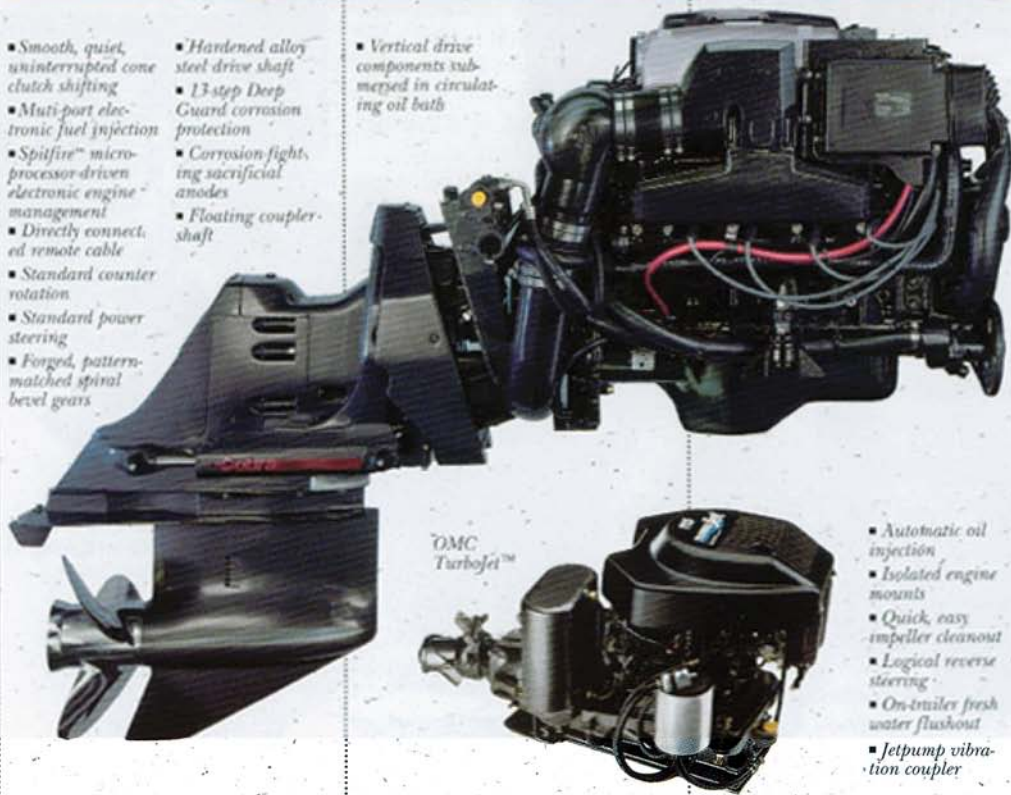

- Automatic oil injection
- Isolated engine mounts
- Quick, easy impeller cleanout
- Logical reverse steering
- On-trailer fresh water flushout
- Jetpump vibration coupler



- Lost foam power-head casting
- VRO oil injection
- 21" trim range
- Cylinder block, exhaust passages and cooling jackets integral to the block
- OMC S.L.O.W.™ overheat warning system
- Teleflex hydraulic steering std. (130-hp and above)

**STERN DRIVE SPECIFICATIONS**

Model	Length	Weight	Displacement	Max. RPM	Max. HP	Max. Torque	Max. Fuel	Max. Oil	Max. Water	Max. Air	Max. Temp	Max. Altitude
<b>OMC Cobra®</b>												
3.0 Liter L4*	A		135	3.0	4000-6000	9.31	208L	4200-4000	870	1.851	15.5	N/A
3.0 Liter L4	A		135	3.0	4000-6000	9.31	208L	4200-4000	700	1.851	15.5	STD
4.3 Liter V6	A	A	160	4.3	4000-6000	9.31	208L	4200-4000	825	1.661	15.5	STD
5.0 Liter V8	A	A	190	5.0	4000-6000	9.31	208L	4200-4000	920	1.661	15.5	STD
5.0 Liter EFI V8	A	A	215	5.0	4000-6000	9.31	208L	4200-4000	810	1.661	15.5	STD
5.8 Liter EFI V8	A	A	255	5.8	4000-6000	9.31	208L	4200-4000	1060	1.511	15.5	STD
<b>OMC King Cobra®</b>												
5.8L HD EFI V8	A	A	270	5.8	4000-6000	9.31	208L	4200-4000	1060	1.831	15.5	STD
7.4L EFI V8	A	A	330	7.4	4250-6000	9.31	208L	4200-4000	1165	1.421	15.5-17	STD

A = Available \* = Twin Counter Rotating Props † = With Manual Steering

**OUTBOARD SPECIFICATIONS**

Model	Length	Weight	Displacement	Max. RPM	Max. HP	Max. Torque	Max. Fuel	Max. Oil	Max. Water	Max. Air	Max. Temp	Max. Altitude
90 HP TL/V4	A		90	3500-5500	99.6	2.0	182L	4500-4000	381	5.01	3.9	AMP
90 HP SL/V4	A		90	3500-5500	99.6	2.0	182L	4500-4000	381	5.01	3.9	AMP
115 HP TL/V4	A	A	90	3500-5500	99.6	2.0	182L	4500-4000	381	5.01	3.9	AMP
115 HP SL/V4	A	A	90	3500-5500	99.6	2.0	182L	4500-4000	381	5.01	3.9	AMP
130 HP TL/V4	A	A	90	3600-5500	122	2.0	182L	4500-4000	381	5.01	3.9	AMP
130 HP EL/V6	A	A	60	3600-5500	158	2.0	182L	4500-4000	381	5.01	3.9	AMP
150 HP EL/V6	A	A	60	3600-5500	158	2.0	182L	4500-4000	381	5.01	3.9	AMP
150 HP EX/V6	A	A	60	3600-5500	158	2.0	182L	4500-4000	381	5.01	3.9	AMP
175 HP EX/V6	A	A	60	3600-5500	158	2.0	182L	4500-4000	381	5.01	3.9	AMP

A = Available

**OMC TURBOJET SPECIFICATIONS**

Model	Length	Weight	Displacement	Max. RPM	Max. HP	Max. Torque	Max. Fuel	Max. Oil	Max. Water	Max. Air	Max. Temp	Max. Altitude
OMC TurboJet 115	A		90	3500-5500	99.6	2.0	182L	4500-4000	381	5.01	3.9	AMP



## WINNGEAR



**W**INNGEAR™ is the trademark of the bold, bright, stylish collection of shirts, sweaters, jackets, shorts, sweats, headwear and accessories Four Winns has designed to keep you looking your nautical best on the water or around town. The smart-looking apparel provides casual comfort. The handy accessories are perfect for boat, car or home use. All the WINNGEAR items shown and described on the next two pages are available exclusively from your Four Winns dealer. To order, make your selection and see or call your Four Winns dealer.

**A Victory Jacket**

100% nylon taffeta with heavy-weight fleece inside. By GEAR®. Purple, Navy. S,M,L,XL,XXL. 9251000. \$57.00\*

**B Crew Neck Sweater**

100% cotton knit top with pebble knit bottom. Red, Navy, White. S,M,L,XL,XXL. 9011500. \$45.00\*



**C Four Winns Sweater**

100% cotton with Four Winns knitted in. Natural. S,M,L,XL,XXL. 9012500. \$55.00\*

**D Four Winns T-Shirt**

100% cotton by GEAR®. Purple. S,M,L,XL. 9290800. \$20.00

**F Tote Bag**

Waterproof interior, canvas exterior. Two end-zip compartments. Removable shoulder strap. Grey w/Teal trim. 24"x11"x11". 9017300. \$28.00

**E Clipper Jacket**

Waterproof poly/cotton zip by GEAR®. Contrasting colors. Navy with Jade trim, Red with Navy trim. S,M,L,XL,XXL. 9200130. \$72.00\*



**G Embroidered Sweatshirt**

80% cotton, 20% polyester fleece by CROSS CREEK®. Navy with Jade trim. M,L,XL,XXL. 9506000. \$44.00\*

**H Sweatpants with Pockets**

80% cotton, 20% polyester fleece by CROSS CREEK®. Navy. S,M,L,XL. 9243000. \$31.00

**I Fling T-Shirt**

100% cotton by GEAR®. White. S,M,L,XL. 9290800. \$20.00

\*Add \$3.00 for XXL.



**A Four Winns Polo Shirt**

100% combed cotton mesh. Tone-on-tone logos. Purple, Coral, Maize, Red, Jade, White. S,M,L,XL,XXL. 9007200. \$25.00\*

**D Twill Shorts**

100% cotton twill, pleated front. Tan, Navy, White. 28 to 42. 9269600. \$25.00. Add \$3.00 for size 42.

**E Logo Lapel Pin**

Four Winns mark. Antique Brass and Polished Gold. Approx. 1/2" 9027000. \$9.00

**F Four Winns Color Collar Polos**

100% combed cotton mesh by GEAR®. Coordinated logos. White w/Multi Navy collar and cuffs. White w/Multi Jade collar and cuffs. S,M,L,XL,XXL 9007500. \$33.00\*

**G Soft Top Hat**

Tone-on-tone logo. Leather adjustment strap. Natural. 9019400. \$15.00

**J Canton Crew Shirt**

100% heavyweight cotton, by KING LOUIE®. Wild 6-color skier graphic. White. S,M,L,XL,XXL 9505000. \$30.00\*

**K Four Winns Pro-Line Hats**

Embroidered, leather adjustment strap. Navy bill and trim. Red bill and trim. 9019300. \$19.00

**I Key Fob**

A must for every boat! It floats! 9017500. \$2.00

**L Cross® Pens**

14k Gold w/Gold Four Winns logo. 9027100. \$70.00  
Charcoal w/Royal Four Winns logo. 9027200. \$42.00\*

**L Garland® Pen**

Royal w/Gold trim "Four Winns" engraved on barrel. Logo in top bubble. 9027300. \$16.00

**B Can Cooler**

Insulated foam. Set of four. Royal w/White logo. 9017400. \$9.00

**C Papermate Pens**

Silkscreened Four Winns on rubber grip pen. Grey w/Royal silkscreen. Blue w/Grey silkscreen (priced by the dozen.) 9027400. \$24.00 doz.



\*Add \$3.00 for XXL.



## Easy towing... easy on-off Four Winns Sure Load™ trailers.

### FACTORY-PATTERNED AND CUSTOM-FITTED

We want you to have the best over-the-road support system available. For 10 years, we've been manufacturing our own premium quality Sure Load™ brand trailer. That's an advantage very few other boat builders offer. While other builders specify adjustable bunk or roller model trailers from an independent manufacturer, we custom pattern a quality, structural steel, single or tandem axle, bunk-type trailer for every Four Winns. Optional on Vista, standard all other models.

### A TOUGH, RELIABLE BUILD

The design-matched Four Winns Sure Load trailer provides a rugged, all-welded 11-gauge tubular steel frame and tuned leaf springs for maximum support. Carpeted bunks rest directly beneath hull stringers to absorb the impact boats are subjected to during towing. Wheel bearings, wiring harness and running lights are sealed and protected.



A low-silhouette design creates a stable, easy towing package.



A low profile aids at launch time, often allowing the boat to be floated off the trailer.



Convenient positioning of side guides, angled bunks, and a recessed frame-mounted roller make it easier to drive the boat onto the trailer.



Removable tongue is handy for storage and as a security feature.

### LOW SILHOUETTE...EASY ON-OFF DESIGN

With some boat/trailer rigs, the experience at the ramp can cause anxiety. The Sure Load low silhouette design aids in driving your boat on and off the trailer at the launch.



Welder Dave Smith follows rigid quality control standards at the Four Winns Trailer Plant.



Scott Hudson applies one of two coats of color-matched polyurethane to a Four Winns trailer.

### TOUGH... AND BEAUTIFUL

Sure Load trailers are perfectly color-matched to the primary accent color of each model\* with a diamond-hard polyurethane finish over a zinc chromate primer. A bottle of matching paint comes with the trailer, so you can touch up inadvertent dings and scratches. Spare tire, aluminum wheels, surge brakes\*\* and galvanized body are optional.

#### Other Value Features:

- Galvanized jack stand
- Winch w/bow roller assembly and nylon strap
- Boat tie-down straps
- Galvanized hitch
- Non-skid step pads
- Fender splash guards
- Enclosed wiring
- Removable tongue (except Fling)

\* White on Fling

\*\* Surge brakes required on multi-axle trailers

#### Fast Feature Finder

The page to the right includes itemized listings of standard and optional features for each Four Winns model. Open the catalog to the pages pertaining to the Four Winns model you are interested in...then fold out the "Fast Feature Finder" section as indicated below.









## COLORS & FABRICS

The brilliant 100% Armorcote finish on Four Winns boats is available in six vibrant two-tone combinations...White with Deep Ruby, White with Fathom Blue, White with Poppy Red, White with Lagoon Teal, White with Forest

Green, and White with Rich Plum. Two-tone is optional on Freedom and standard on Horizon, Candia, Sundowner and Vista. Fling is available in White only with bright Blueberry/Lime, Tangerine/Plum or Dark Jade/Stone vinyl and graphic accents. For more specific information about Armorcote exterior finishes please see page 5.

## COLORS

### Fling



White with Blueberry/Lime accents

White with Tangerine/Plum accents

White with Dark Jade/Stone accents

### Freedom/Horizon/Candia/Sundowner/Vista



White with Deep Ruby

White with Fathom Blue

White with Poppy Red



White with Lagoon Teal

White with Forest Green

White with Rich Plum

## FABRICS

### Sundowners



Upholstery pattern all Sundowners

### 238/258/278 Vista



Vee-berth/midcabin upholstery pattern all Vistas

### Dinette upholstery pattern 278 Vista



With Lagoon Teal or Forest Green exterior



With Fathom Blue exterior



With Deep Ruby/Poppy Red/Rich Plum exterior

## SUNBRELLA CANVAS

All Four Winns boats are beautifully complemented by color-matched Sunbrella canvas available in a variety of configurations. Factory-patterned tops are custom-sewn to provide a tailored fit for each Four Winns model. Installation of full camper canvas is made easier with port and starboard color coding on the inseams. Available variations are shown below. Please see page 6 for more information about Sunbrella canvas.



Std. convertible top w/opt. camper canvas (Horizon/Sundowner) and bow cover (Horizon).



Std. convertible top (Freedom/Horizon/Sundowner).



Opt. mooring cover.



Std. convertible top w/opt. side and aft curtains.



Std. Bimini top for Fling and Candia.



Opt. cockpit cover and bow cover.



Std. Sunbrella full camper canvas for all Vista models.



Opt. Bimini top (Fling/Horizon/Sundowner) and bow canopy (240 Horizon only).



*Four Winns Professional  
Marine Retailer...our most important ally...  
your most important standard feature.*



There's an exclusive standard feature of every Four Winns boat that is

simply not available from any other brand...the Four Winns Professional Retailer. As proud and confident as we are of our Four Winns boats, we are equally proud and confident of our dealer network.

Four Winns dealers are highly trained professionals, carefully selected for their business savvy, their knowledge of boats and marine issues, and their commitment to customer satisfaction. In fact, surveys that we conduct regularly show the



*You'll find the Four Winns Dealer personnel to be helpful, knowledgeable, friendly and professional.*

average Four Winns Dealer scores over 90% on the OMC CSI (Customer Satisfaction Index).

Four Winns Dealers are our valued partners, specifically trained in the Four Winns philosophy. We know them to be courteous and dedicated to helping match

you and your family to an affordable, comfortable Four Winns model with the features and performance to fit your boating lifestyle.

Not only can they assist you in making your selection, they can provide on-the-spot financing and insurance...help you select the

accessories that will make boating more hassle-free and enjoyable...and show you a selection of comfortable, casual Winngear™ apparel that will always have your family looking their boating best.

**WE LISTEN TO OUR  
DEALERS...**

Our dealers provide us with constant feedback. They know what you want and need. That helps us design boats better, so they are easier to use, and provide more value at resale time. We are



*With performance like Four Winns provides, your Four Winns dealer is always glad to offer a test drive.*

in constant contact with our dealers by phone and fax. We visit them frequently throughout the year, and they come to our world headquarters in Cadillac, Michigan to stay informed about product and processes at Four Winns and gain the insights to help them be of more assistance to you.

Beyond building outstanding boats, our mission is to make it more conve-



*Four Winns dealers are frequent visitors at our test center in Cadillac, Michigan.*

nient and hassle-free for you to get into boating. We are confident that the Four Winns Professional Marine Retailer in your area is eminently qualified to make it happen. **Give Your Family Our Best.**



*A full range of training programs are maintained exclusively for Four Winns dealers, their customer representatives and service technicians.*