



F SERIES

OWNERS MANUAL

090-3092



WARNING

A wide variety of components used on this vessel contain or emit chemicals known to the State of California to cause cancer and birth defects and other reproductive harm.

EXAMPLES INCLUDE:

- Engine and generator exhaust
- Engine and generator fuel, and other liquids such as coolants and oil, especially used motor oil
- Cooking fuels
- Cleaners, paints, and substances used for vessel repair
- Waste materials that result from wear of vessel components
- Lead from battery terminals and from other sources such as ballast or fishing sinkers

TO AVOID HARM:

- Keep away from engine, generator, and cooking fuel exhaust fumes
- Wash areas thoroughly with soap and water after handling the substances above

GM2203301

PREFACE	10
SAFETY MESSAGES	11
OPERATION	17
A - 1 GENERAL	17
A - 2 COMPONENT SYSTEMS	17
A - 3 SAFETY EQUIPMENT	17
A - 4 PASSENGER SAFETY	17
A - 5 RULES OF THE ROAD	17
A - 6 LIGHTNING.....	17
A - 7 DRUGS AND ALCOHOL.....	18
A - 8 PRE-CRUISE SYSTEM CHECK	18
A. Before Starting The Engines	18
B. After Starting The Engine	18
A - 9 ENGINE OPERATIONAL PROCEDURES	18
A. Before Starting	19
B. Cold/Warm Engine Start - EFI Engines	19
C. Shifting and Control Speed.....	19
D. Stopping Engine.....	20
A - 10 GROUNDING AND TOWING	20
A - 11 BOATING EDUCATION	21
A. Boating Courses.....	21
B. Boating Manuals or Literature	21
C. Charts and Maps.....	21
D. Laws and Regulations	21
A - 12 BOAT OWNER REGISTRATION	21
A - 13 ACCIDENT REPORTING	22
A - 14 DISCHARGE OF OIL	22
A - 15 DISPOSAL OF PLASTICS & OTHER GARBAGE	22
A - 16 MARPOL TREATY	22
BOATING SAFETY	24
B - 1 GENERAL	24
A. Required Safety Equipment	24
B. Personal Flotation Devices (PFDs).....	24
C. PFD Types.....	24
D. PFD Pointers	25
E. Fire Extinguisher	25
F. Visual Distress Signal Devices	26
G. Sound Signaling Devices	26
H. Navigation Lights.....	27
I. Additional Recommended Equipment	27
B - 2 CARBON MONOXIDE.....	27
A. Properties and Characteristics of Carbon Monoxide.....	28
B. What Makes Carbon Monoxide	28
C. How a Person is Affected by Carbon Monoxide.....	28
D. Effects of Carbon Monoxide	28
E. Symptoms	28
F. Treatment (Evaluate, Ventilate, Evacuate, Investigate, Take Corrective Action).....	28
G. Inspection.....	29
H. Operation	29

I.	Boathouses, Sea Walls and Confined Spaces	29
J.	The Effect of Boats Moored Along Side	30
K.	Backdrafting (Station Wagon Effect).....	30
L.	Accumulation of Exhaust Gases - Swim Platform	31
M.	Dangerous Activity - “Teak Surfing”/“Dragging”	31
N.	Cabin Appliances	31
O.	Air Conditioning (Applicable Models Only).....	31
P.	Ventilation of Accommodation (Occupied) Spaces	31
Q.	Running of Engines in Idle.....	31
R.	Altitude and Sea Conditions	31
S.	Portable Generator Sets.....	32
T.	Maintenance - Engine Performance	32
U.	Maintenance - External Conditions.....	32
V.	Maintenance - Exhaust System Integrity	32
W.	Maintenance - Ventilation Systems	33
X.	Maintenance - Bulkhead and Deck Integrity	33
Y.	Maintenance - Air Conditioning Systems (Applicable Models Only).....	33
Z.	Maintenance - Liquid Drains.....	33
AA.	Carbon Monoxide Monitor (Applicable Models Only)	33
B - 3	SAFE BOATING PRACTICES	34
	A. Drugs and Alcohol.....	34
	B. Safe Operation	34
	C. Passenger Safety.....	35
	D. Propeller.....	35
	E. First Aid.....	35
	F. Operation By Minors	35
	G. “Rules of the Road”	35
	H. Voluntary Inspections	35
	I. Safe Boating Courses	36
B - 4	WATER SPORTS	36
	A. Water Sport Guidelines	36
	B. Water Skiing/Wakeboarding/Kneeboarding.....	37
	BASIC SEAMANSHIP	38
C - 1	GENERAL	38
	A. Boating Regulations	38
	B. Rules of Seamanship	38
C - 2	NAVIGATIONAL AIDS	40
	A. International Association of Lighthouse Authorities System B (IALA-B)	40
	B. Lateral Markers	40
	C. Safe Water Markers	40
	D. The Uniform State Waterway Marking System	41
	E. A Special Sign.....	41
	F. Noise	41
C - 3	ANCHORING	41
C - 4	RECOMMENDED READING	42
C - 5	CONTACTS	42
C - 6	OWNER’S LOGS AND RECORDS	43
C - 7	NAVIGATIONAL AIDS CHART	43

WARRANTY AND SERVICE	44
D - 1 FOUR WINNS WARRANTY POLICY	44
D - 2 DECK/HULL STRUCTURE WARRANTY	44
D - 3 WARRANTY REGISTRATION	44
D - 4 TRANSFER OF WARRANTY	44
D - 5 PRE-OWNED UNIT REGISTRATION	44
D - 6 INSURANCE COVERAGE	45
D - 7 SERIAL NUMBER RECORD.....	45
D - 8 PRE-DELIVERY SERVICE.....	45
D - 9 REPLACEMENT PARTS.....	45
D - 10 OWNER'S RESPONSIBILITIES.....	45
D - 11 CONSTRUCTION STANDARDS.....	46
D - 12 WINNGEAR.....	46
D - 13 NAME/ADDRESS CHANGE FORM	48
D - 14 WARRANTY REGISTRATION TRANSFER REQUEST	50
ENGINES AND INSTRUMENTATION	52
E - 1 GENERAL	52
E - 2 ENGINE EXHAUST	52
E - 3 ENGINES	53
E - 4 PROPELLERS	53
A. Diameter	53
B. Pitch.....	53
C. Prop Slip	53
E - 5 RUNNING ANGLE & POWER TRIM/TILT	54
A. Power Trim.....	54
B. Power Tilt.....	54
E - 6 TRIM TABS (Applicable Models Only)	54
A. Control Listing	55
B. Induce Planing & Controlling Trim Angle	55
C. Trim Tab Maintenance (Applicable Models Only)	55
E - 7 INSTRUMENTATION	56
A. Tachometer/Hour Meter Combination Gauge.....	56
B. Speedometer	57
C. Temperature Gauge (4-in-1 Gauge).....	57
D. Oil Pressure Gauge (4-in-1 Gauge).....	57
E. Voltmeter (4-in-1 Gauge).....	58
F. Fuel Gauge (4-in-1 Gauge)	58
G. Power Trim Gauge	58
H. Depth Sounder	58
I. Four Position Ignition Switch	60
J. Emergency Stop Switch	60
K. Alarm Systems	60
L. Compass.....	61
M. Instrument Maintenance.....	61
CONTROL SYSTEMS	62
F - 1 GENERAL	62
F - 2 CONTROL OPERATION	62
A. General	62

	B. Maneuvering of Side-Mount Control	63
	C. Shifting and Control Speed.....	63
F - 3	NEUTRAL SAFETY SWITCH.....	64
F - 4	CONTROL SYSTEM MAINTENANCE	64
STEERING SYSTEMS.....		65
G - 1	GENERAL	65
	A. Rotary Steering	65
	B. Tilt Steering	65
	C. Power Steering.....	65
G - 2	PROPELLER TORQUE.....	66
G - 3	STEERING SYSTEM MAINTENANCE.....	66
	A. General Maintenance	66
	B. Rotary System Maintenance	66
	C. Winter Storage	67
ELECTRICAL SYSTEMS		68
H - 1	GENERAL	68
H - 2	SINGLE ENGINE - DUAL BATTERY SYSTEM	69
	A. Installation	69
	B. Battery Switch Operation.....	69
H - 3	VOLTMETER	70
H - 4	12 VOLT ELECTRICAL EQUIPMENT	70
	A. Helm Equipment.....	70
	B. Installation of Additional 12 Volt Equipment.....	71
	C. Interior Equipment.....	71
H - 5	12 VOLT ELECTRICAL SYSTEM SHUTDOWN PROCEDURES.....	72
H - 6	ELECTRICAL SYSTEM MAINTENANCE	72
	A. Battery Maintenance	72
	B. Electrical Wiring Maintenance	73
H - 7	STRAY CURRENT CORROSION	74
	A. General	74
	B. Galvanic Corrosion.....	74
	C. Corrosion Prevention.....	74
FUEL SYSTEMS		75
I - 1	GASOLINE FUEL SYSTEMS	75
	A. Fuel System - Domestic Models.....	75
	B. Fuel System - Export Models	76
	C. System Testing	77
	D. Fuel Fills - Domestic Models	77
	E. Fuel Vents - Domestic Models.....	78
	F. Fuel Fills - Export Models.....	79
	G. Anti-Syphon Valve.....	79
	H. Fuel Gauge	80
	I. Fuel Sender	80
	J. Fuel Filters	80
	K. Use and Maintenance	81
I - 2	FUEL STANDARDS	81
	A. Problems With Alcohol in Gasoline.....	81
	B. Recommendations	81

I - 3	FUELING INSTRUCTIONS	82
WATER AND WASTE SYSTEMS		83
J - 1	GENERAL	83
J - 2	DISINFECTING THE FRESH WATER SYSTEM	83
J - 3	FRESH WATER SYSTEMS	84
	A. Integrated Sinks	84
	B. Forward & Aft Showers	85
J - 4	WASTE SYSTEMS.....	86
	A. Enclosed Heads.....	86
	B. Porta-Potti	86
	C. Porta-Potti w/Pump-Out	87
J - 5	SYSTEM MAINTENANCE.....	88
	A. Clean Vents and Screens.....	88
	B. Winterizing the Water System	88
VENTILATION AND DRAINAGE SYSTEMS		91
K - 1	ENGINE COMPARTMENT VENTILATION.....	91
	A. Natural Ventilation System	91
	B. Forced Air Ventilation	91
	C. Engine Ventilation System Maintenance	91
K - 2	HULL DRAINAGE SYSTEMS.....	91
	A. Transom Drain	91
	B. Bilge Pump.....	91
	C. Liner Drains.....	92
	D. Bilge Compartment Drainage	92
INTERIOR EQUIPMENT.....		93
L - 1	INTEGRATED SINK.....	93
L - 2	INTEGRATED SINK & COOLER.....	93
L - 3	BUILT-IN ICE CHESTS	93
L - 4	HEADS.....	93
L - 5	STEREO.....	94
L - 6	ANCHOR/LADDER STORAGE	94
L - 7	IN-FLOOR SKI LOCKER.....	94
L - 8	BOW STORAGE	95
L - 9	BOW FILL-IN CUSHIONS	95
L - 10	STERN SEAT STORAGE.....	95
L - 11	STARBOARD CONSOLE STORAGE LOCKER.....	95
L - 12	WALK-THRU DOOR	96
L - 13	COCKPIT TABLE	96
EXTERIOR EQUIPMENT		97
M - 1	RAILS & DECK HARDWARE	97
	A. Rails	97
	B. Cleats.....	97
	C. Transom Ski Tow	98
	D. Bow Scuff Plate.....	98
	E. Maintenance	98

M - 2	WINDSHIELDS	98
M - 3	ANCHOR/LADDER LOCKER.....	99
M - 4	AFT SWIM PLATFORM AND LADDER.....	99
M - 5	TRANSOM WALK-THRU BACKREST DOOR.....	100
M - 6	DOCKING LIGHTS.....	100
M - 7	WAKEBOARD TOWER & SST ARCH.....	100
M - 8	WAKEBOARD TOWER & SST ARCH CARE.....	101
M - 9	FLAG POLE & HOLDER	101
UPHOLSTERY		102
N - 1	EXTERIOR SEATING	102
	A. Bow Seating.....	102
	B. Bucket Seats.....	102
	C. U-shaped Stern Seating.....	104
	D. Engine Hatch	104
	E. Sidewall Storage	105
	F. Swim Platform Lounge Seating	105
	G. Fishing Seats	105
N - 2	EXTERIOR UPHOLSTERY CARE	106
	A. Cleaning Vinyl.....	106
	B. Exterior Carpets	107
	C. Cleaning and Maintenance.....	108
	D. Stain Removal Testing	108
	E. Stain Removal Procedures.....	108
N - 3	REPLACEMENT UPHOLSTERY	108
WEATHER COVERS.....		110
O - 1	GENERAL INFORMATION	110
	A. Bimini Top (Aft/Main)	110
	B. Forward Bimini Canvas	111
	C. Camper Canvas.....	111
	D. Forward Cover	112
	E. Cockpit Cover	112
	F. Mooring Cover	112
O - 2	TRAILERING.....	113
O - 3	WINTER STORAGE.....	113
O - 4	USE OF WEATHER COVERS AND CARBON MONOXIDE	113
O - 5	MAINTENANCE	114
FIBERGLASS AND HULL.....		115
P - 1	HULL DESIGN INFORMATION.....	115
P - 2	FIBERGLASS CONSTRUCTION	115
P - 3	EQUIPMENT INSTALLATION.....	115
P - 4	FIBERGLASS CARE & MAINTENANCE	115
	A. General Maintenance.....	115
	B. Weathering Effects on Gel Coat	116
	C. Stains.....	117
P - 5	FIBERGLASS REPAIRS	117
	A. Scratches	117
	B. Gouges & Cracks.....	117
	C. Osmotic Blistering	118

P - 6	ANTI-FOULING PAINT	119
P - 7	HULL SUPPORT	119
WOODWORK AND COMPOSITES		120
Q - 1	HIGH-PRESSURE LAMINATE CARE	120
Q - 2	STAR BOARD	120
Q - 3	METALLIC FINISHES	120
Q - 4	LAMINATED FIBERGLASS	120
Q - 5	SOLID SURFACE MATERIAL	121
Q - 6	ACRYLYC PLASTIC - (Plexiglass)	121
GENERAL MAINTENANCE		123
R - 1	WINTERIZATION	123
	A. Prior to Lifting for Winter Lay-up	123
	B. After Lifting	123
	C. Prior to Winter Storage	124
R - 2	GENERAL MAINTENANCE SCHEDULE	125
TRAILER INFORMATION		128
S - 1	GENERAL TRAILER INFORMATION	128
	A. Regulations	128
	B. Load Carrying Capacity	128
	C. Hitches	129
S - 2	TRAILER COMPONENTS	129
	A. Bunk Supports	129
	B. Tongue	130
	C. Swivel Jack	130
	D. Surge Brakes & Coupling Assembly	131
	E. Winch	132
	F. Tires & Wheels	132
	G. Spare Tire Carrier	133
	H. Lights	133
	I. Tie-downs	134
S - 3	OPERATION	135
	A. Hitching Trailers	135
	B. Backing Up with Surge Brakes	137
S - 4	TRAILERING	138
	A. Checklist	138
	B. Tactics	138
S - 5	MAINTENANCE	139
	A. Care of Exterior Finish	139
	B. Bunks	139
	C. Swivel Jack	139
	D. Brake Actuator & Coupling Assembly	139
	E. Winch	140
	F. Lights	140
	G. Tie-downs	140
	H. Wheels	140
	I. Brakes	140
	J. Bearings	140
S - 6	AXLE INSPECTION & REPAIRS	141

	A. Removal of Hub	141
	B. Bearing/Seal Inspection and Replacement.....	142
	C. Hub Reinstallation	142
S - 7	SUPPLEMENTAL TRAILER INFORMATION	142
	A. Information Contained on Sidewall of the Tire	142
	B. Sample Tire Registration.....	143
	C. Inflating Your Tires	143
	D. Load Carrying Capacity.....	144
	E. Glossary of Tire Terminology	145
PRE-LAUNCH AND UNDERWAY.....		146
T - 1	LAUNCH & CRUISE CHECKLIST	146
T - 2	FUELING.....	147
	A. Recommendations	147
	B. Preliminary Guidelines	147
	C. Pumping Fuel.....	147
	D. After Fueling.....	147
T - 3	LOADING PASSENGERS & GEAR	148
T - 4	STARTING PROCEDURES	149
	A. Preliminary Checks	149
	B. Starting.....	149
T - 5	MANEUVERING.....	150
	A. Leaving the Dock	150
	B. Stopping.....	150
T - 6	ACCELERATION.....	151
T - 7	TRIMMING YOUR BOAT	151
	A. Trim Tabs (Applicable Models Only).....	151
	B. Tilt/Trim Control Switches.....	152
T - 8	NAVIGATION LIGHTS.....	153
T - 9	HAZARDOUS CONDITIONS.....	153
	A. Storms	153
	B. Fog.....	154
	C. Running Aground	154
	D. Warning Markers.....	154
T - 10	REACTING TO EMERGENCIES.....	154
	A. Flooding	154
	B. Capsizing and Man Overboard.....	155
	C. Capsizing	155
	D. Man Overboard	155
	E. Collision	155
	F. Fire.....	155
	G. Medical Emergency.....	156
	H. Propulsion Failure	156
	I. Control Failure.....	156
	J. Steering Failure.....	156
	K. Additional Underway Information.....	156
T - 11	RETURNING TO SHORE.....	157
	A. Docking.....	157
	B. Mooring.....	157

GLOSSARY	158
FLOAT PLAN	165
FUEL LOG	166
SERVICE LOG	169
SERVICE INFORMATION	172

Congratulations on your new boat purchase and welcome to our boating family!

We want your boating experience to be the most enjoyable possible. The more you know about your new boat, the more you'll enjoy the time you spend aboard. That's why we prepared this manual. It's your guide for safe operation as well as understanding your boat's systems and equipment. It has been written for the beginning boater but experienced boaters will find helpful information as well. Be sure to read the contents thoroughly.

This manual will acquaint you with the use and maintenance of your new Four Winns boat. This manual also provides special information critical to the safety of the passengers, and longevity of the equipment. The information on the following page lists the graphics used to increase the visibility of these important messages. Also included in your owner's packet is the "Boating Basics, A Guide to Responsible Boating". This guide covers boating basics and should be read along with your Four Winns owner's manual before operating your boat. Review this information completely before using your new boat. **Please refer to our website for further updated information and possible revisions to this manual.**

Four Winns continually strives to improve its products. Unit specifications, including standard and optional equipment are constantly being modified. **Equipment availability is also subject to change without notice. The most current and accurate information available at the time of publication is included in this manual. Some variation in material, equipment, description, location, and details can result.**

The information in this manual focuses upon the equipment designed and manufactured by Four Winns on specific models. When appropriate, please utilize the information pertinent to your specific boat model.

Equipment such as engines, and other accessories are manufactured by others. **The information provided in this manual is intended to be used in conjunction with the information provided by the manufacturers of this equipment.** All information available at the time of manufacture has been included with your owner's packet. In many cases, replacement of manufacturer's literature may be obtained via their respective websites.

Read this entire manual carefully before operating your new boat. Many instructions may require direct performance of the activity to fully understand the correct method. If you choose to read this manual at home, remember to take it to the boat with you.

Your Four Winns dealer knows your boat best and is committed to your complete satisfaction. Return to the dealer for service or other assistance. If you find it necessary to contact Four Winns directly, please refer to the contact information listed below. Be sure to include the boat model, hull identification number, your daytime telephone number, and specifics of the information desired.

This manual has been specifically developed for the F series models. Please record the model and hull identification number information below.

Model

Hull Identification Number

This manual should be considered part of the boat. Should you sell the boat, pass this manual on to the new owner. Take special care of this manual. Certain information in this manual may not be available in a replacement manual. An electronic version of this manual may be viewed on our website at www.fourwinns.com.

Thank you for joining the Four Winns family. We appreciate your purchase and welcome the opportunity to demonstrate our commitment to you.

**Four Winns Customer Service Department
925 Frisbie Street
Cadillac, Michigan 49601**

231 775-1343 (Phone)

231 779-2345 (Fax)

E-mail Address: boating@fourwinns.com

©Rec Boat Holdings, LLC 2012 All Rights Reserved.

The popularity of boating and other water sports has grown tremendously in the past few years. Because of this, safety is an important issue for everyone who shares our waterways.

Remember that along with the freedom and exhilaration of boating comes the responsibility that you have for the safety of your passengers and the other boaters who share the water with you. Throughout this manual, specific precautions and symbols identify safety-related information. Be sure to pay close attention to them.

NOTICE

Boxes that are gray require your special attention. Notice boxes include helpful boating practices and law reminders.



This symbol means “pay attention!” Here is important information for your safety. If you don’t follow these instructions, you can damage your boat, hurt yourself or someone else or, even worse, have a fatal accident.



This symbol and signal word indicate a potentially hazardous situation. If you ignore this safety message, property damage or minor or moderate personal injury MAY or CAN result.



This symbol and signal word indicate a potential hazard. If you ignore this safety message, serious injury or death CAN result.



This symbol and signal word indicates an immediate hazard. If you ignore this safety message, serious personal injury or death WILL result.

The precautions in this manual can not and do not cover every boating situation. If a specific method or procedure is not recommended, you must make sure that what you do is safe for you and others. Always use common sense when boating! Remember to make sure that every safe boating excursion is a happy experience.

IMPORTANT HEALTH AND SAFETY INFORMATION ABOUT YOUR NEW BOAT

WARNING

A wide variety of components used on this vessel contain or emit chemicals known to the State of California to cause cancer and birth defects and other reproductive harm.

EXAMPLES INCLUDE:

- Engine and generator exhaust
- Engine and generator fuel, and other liquids such as coolants and oil, especially used motor oil
- Cooking fuels
- Cleaners, paints, and substances used for vessel repair
- Waste materials that result from wear of vessel components
- Lead from battery terminals and from other sources such as ballast or fishing sinkers

TO AVOID HARM:

- Keep away from engine, generator, and cooking fuel exhaust fumes
- Wash areas thoroughly with soap and water after handling the substances above

GM2203301

We'd also like to remind you to be kind to our environment while you're boating. Don't throw garbage and other refuse overboard. Do your best to keep harmful compounds like gasoline, oil and antifreeze out of the water. Please see the notifications below:

DISCHARGE OF OIL PROHIBITED

THE FEDERAL WATER POLLUTION CONTROL ACT PROHIBITS THE DISCHARGE OF OIL OR OILY WASTE INTO OR UPON THE NAVIGABLE WATERS OF THE UNITED STATES, OR THE WATERS OF THE CONTIGUOUS ZONE, OR WHICH MAY EFFECT NATURAL RESOURCES BELONGING TO, APPERTAINING TO, OR UNDER THE EXCLUSIVE MANAGEMENT AUTHORITY OF THE UNITED STATES, IF SUCH DISCHARGE CAUSES A FILM OR DISCOLORATION OF THE SURFACE OF THE WATER OR CAUSES A SLUDGE OR EMULSION BENEATH THE SURFACE OF THE WATER. VIOLATORS ARE SUBJECT TO SUBSTANTIAL CIVIL PENALTIES AND/OR CRIMINAL SANCTIONS INCLUDING FINES AND IMPRISONMENT.

Oil Discharge Plate - (Specific Models Only - Location Not Shown)

It is illegal for any vessel to dump plastic trash anywhere in the ocean or navigable waters of the United States. Annex V of the MARPOL TREATY is an

international Law for a cleaner, safer marine environment. Violation of these requirements may result in civil penalty up to \$25,000, fine and imprisonment.



U.S. Lakes, Rivers, Bays, Sounds and 3 miles from shore
ILLEGAL TO DUMP Plastic & Garbage
Paper Metal
Rags Crockery
Glass Dunnage
Food

3 to 12 miles
ILLEGAL TO DUMP Plastic

Dunnage, lining & packing materials that float, also if not ground to less than one inch:
Paper Crockery
Rags Metal
Glass Food



12 to 25 miles
ILLEGAL TO DUMP Plastic
Dunnage, lining & packing materials that float



Outside 25 miles
ILLEGAL TO DUMP Plastic



State and local regulations may further restrict the disposal of garbage.

Trash Overboard Decal - (Specific Models Only - Location Not Shown)



This manual has been compiled to help you operate your boat with safety and pleasure. It contains the details of the boat, the equipment supplied or fitted, its systems, and information on its operation and maintenance. Please read it carefully and familiarize yourself with the boat before using it.

If this is your first boat, or if you are changing to a type of boat you are not familiar with, for your own comfort and safety, please ensure that you obtain handling and operating experience before "assuming command" of the boat. Your dealer or national sailing federation or yacht club will be pleased to advise you of local sea schools and competent instructors.

PLEASE KEEP THIS MANUAL IN A SECURE PLACE, AND HAND IT OVER TO THE NEW OWNER WHEN YOU SELL THE BOAT.

LABEL LOCATIONS

The NMMA capacity label and various warning labels are placed at different locations on each model for your safety. Additional warnings for fuel leakage, blower operation, and other important information will be imprinted or located on the dash. Many of these stickers and labels are not required by the U.S. Coast Guard but are important to ensure the safe operation of your Four Winns® boat. In addition, the Hull Identification Number plate is permanently attached below the deck-hull joint on the starboard aft corner.

Below are letters corresponding to the various locations for each item on the drawings. See the following pages of this section for the actual wording of each of the various warning labels found on your boat.

- | | |
|--|--|
| (A) Hull Identification Number Plate | (G) CO Helm Warning |
| (B) Gasoline Vapor-Blower Warning | (H) Ski Tow Warning |
| (C) Rotating Prop Boarding Ladder | (I) Winning Edge Sticker |
| (D) Leaking Fuel | (J) NMMA Certified |
| (E) Capacity Label | (K) CO Swim Platform & Lounging Area (Transom) |
| (F) Rotating Prop Boarding Ladder - Helm | (L) Swim Platform Lounging Seats Warning |

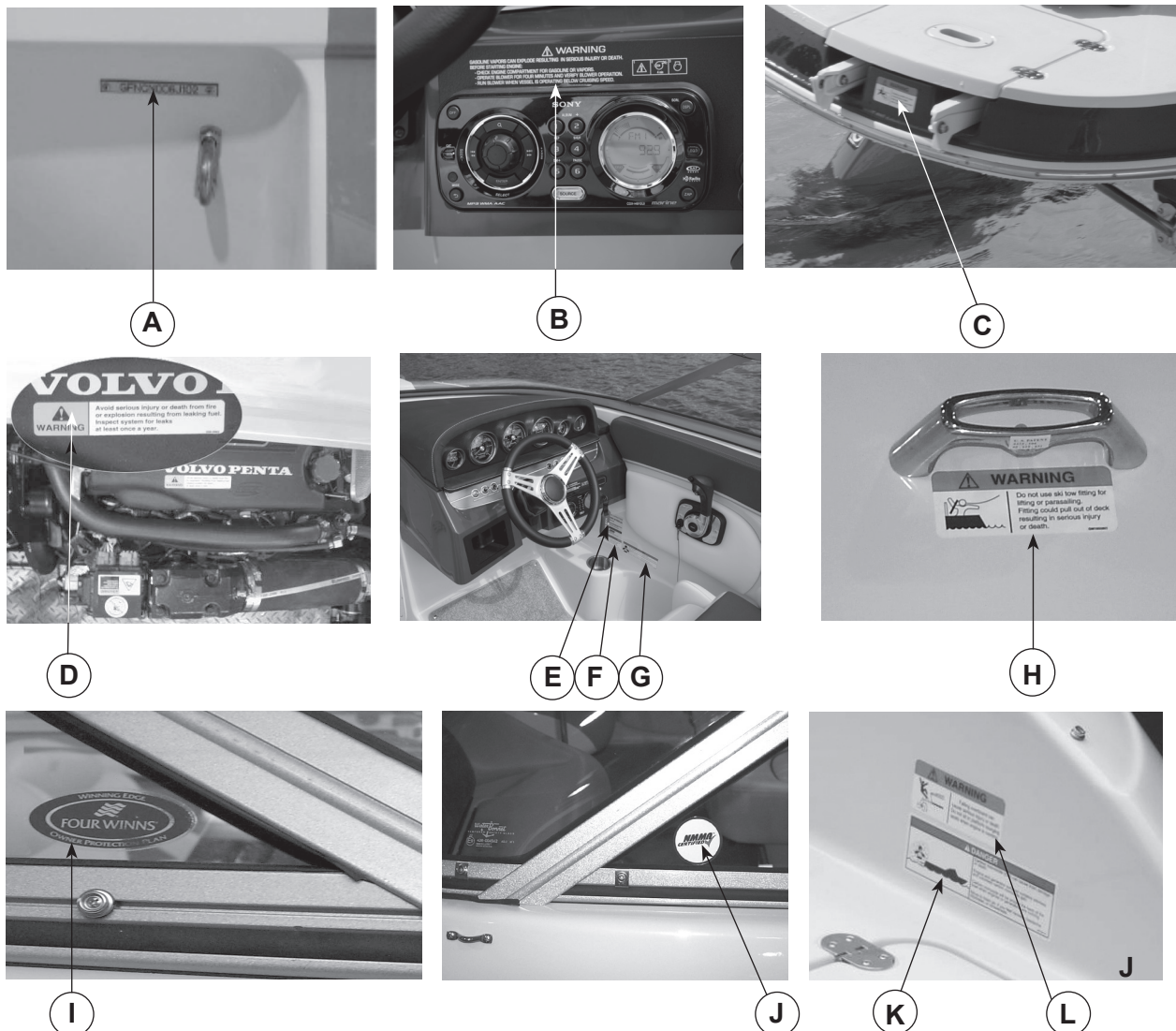

**Figure 1: Warning, Capacity and Other Label Locations - Reference Only
(Location may vary depending on model)**

CAPACITY & WARNING LABELS

Capacity Label
 (See actual capacity plate affixed to boat for actual capacities)

MAXIMUM CAPACITIES

12 PERSONS OR 1800 LBS.

2500 LBS, PERSONS, GEAR

THIS BOAT COMPLIES WITH U.S. COAST GUARD SAFETY STANDARDS IN EFFECT ON THE DATE OF CERTIFICATION

MANUFACTURER: FOUR WINNS CADILLAC MI 49601

MODEL: **SAMPLE** NOTE: SEE CAPACITY LABEL/PLATE AFFIXED TO BOAT FOR ACTUAL CAPACITIES.

DESIGN COMPLIANCE WITH NMMA REQUIREMENTS BELOW IS VERIFIED. MANUFACTURER RESPONSIBLE FOR PRODUCTION CONTROL.

**LOAD CAPACITY * COMPARTMENT VENTILATION
 STEERING, FUEL AND ELECTRICAL SYSTEMS
 NAVIGATION LIGHTS * BASIC FLOTATION
 MANEUVERABILITY**



NATIONAL MARINE MANUFACTURERS ASSOCIATION





Imprinted Label on Ignition Panel

⚠ WARNING

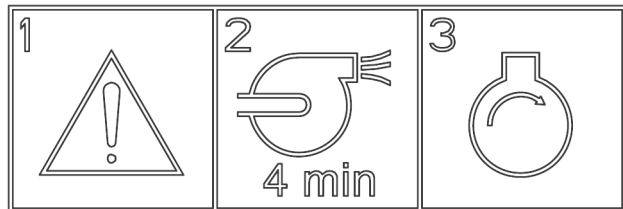
GASOLINE VAPORS CAN EXPLODE RESULTING IN INJURY OR DEATH. BEFORE STARTING ENGINE -CHECK ENGINE BILGE COMPARTMENT FOR GASOLINE OR VAPORS. OPERATE BLOWER FOR FOUR MINUTES AND VERIFY BLOWER OPERATION. RUN BLOWER WHEN VESSEL IS OPERATING BELOW CRUISING SPEED.



WARNING



Gasoline vapors can explode. Before starting engine

- Check engine compartment for gasoline or vapors; and
- Operate blower for four minutes. Run blower when boat is operating below cruising speed.

GM1850501

Gasoline Vapor-Blower Warning Label

WARNING





Rotating propeller can cause serious injury or death. Shut off motor when near persons in water.

GM1850901

Rotating Propeller - Helm Warning Label

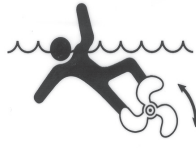
WARNING

Rotating propeller can cause serious injury or death. Never approach or use ladder when motor is running.

GM1851001

Rotating Propeller - Ladder Warning Label

WARNING





Avoid serious injury or death from fire or explosion, resulting from leaking fuel. Inspect system for leaks at least once a year.

GM1850601

Leaking Fuel Warning Label

⚠ DANGER



Carbon monoxide (CO) can cause brain damage or death.

Engine and generator exhaust contains odorless and colorless carbon monoxide gas.

Carbon monoxide will be around the back of the boat when engines or generators are running.

Move to fresh air, if you feel nausea, headache, dizziness, or drowsiness.

NW-205-05

CO Swim Platform and Lounging Area Warning Label

WARNING

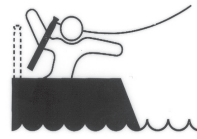



Do not use ski tow fitting for lifting or parasailing. Fitting could pull out of deck resulting in serious injury or death.

GM1850801

Ski Tow Warning Label

WARNING





Fuel vapors are a fire and explosion hazard. To avoid injury or death, do not store fuel or flammable liquids here.

GM1850701

No Ventilation - Do Not Store Fuel Warning Label

WARNING





Prevent falls overboard. Close, latch and stay inside gate(s) while underway.

GM1851101

Transom/Side Door Warning Label

⚠ WARNING



Carbon monoxide (CO) can cause brain damage or death.

Carbon monoxide can be present in the cabin.

Signs of carbon monoxide poisoning include nausea, headache, dizziness, drowsiness, and lack of consciousness.

Get fresh air if anyone shows signs of carbon monoxide poisoning.

Get fresh air if carbon monoxide detector alarm sounds.

Carbon monoxide detector must be functioning at all times.

NW-205-05

CO-Cabin Warning Label (Certain Models Only)

⚠ WARNING



Carbon monoxide (CO) can cause brain damage or death.

Engine and generator exhaust contains odorless and colorless carbon monoxide gas.

Signs of carbon monoxide poisoning include nausea, headache, dizziness, drowsiness, and lack of consciousness.

Get fresh air if anyone shows signs of carbon monoxide poisoning.

See Owner's Manual for information regarding carbon monoxide poisoning.

NW-204-05

CO-Helm Warning Label

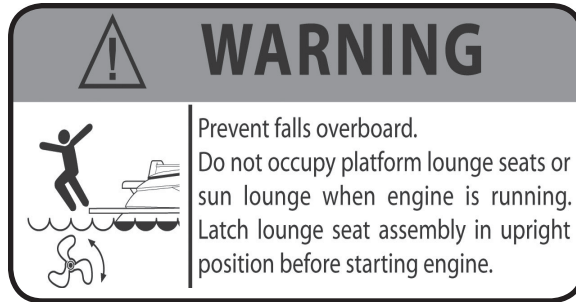



Platform Lounging Seats & Sun Lounge Warning Label



Winning Edge Sticker





NMMA Certified Sticker

CANADIAN COMPLIANCE NOTICE AVIS DE CONFORMITÉ CANADIEN	
MAXIMUM RECOMMENDED SAFE LIMITS LIMITES MAXIMALES DE SÉCURITÉ RECOMMANDÉES	
	7
	525 kg 1157 lbs/lb
	+
	
	544 kg 1200 lbs/lb
<small>THE RECOMMENDED MAXIMUM SAFE LIMITS MAY HAVE TO BE REDUCED IN ADVERSE SEA AND WEATHER CONDITIONS. LES LIMITES MAXIMALES DE SÉCURITÉ RECOMMANDÉES PEUVENT DEVOIR ÊTRE RÉDUITES DANS LES CONDITIONS DE MER ET DES CONDITIONS MÉTÉOROLOGIQUES DIFFICILES.</small>	
FOUR WINNS (PFW) CADILLAC, MI, USA MODEL / MODÈLE: ME	
<small>THE MANUFACTURER DECLARES THAT THIS VESSEL COMPLIES WITH THE CONSTRUCTION REQUIREMENTS OF THE SMALL VESSEL REGULATIONS AS THEY READ ON THE DAY ON WHICH THE CONSTRUCTION OF THE VESSEL WAS STARTED OR ON THE DAY ON WHICH THE VESSEL WAS IMPORTED. LE FABRICANT ATTESTE QUE CE PRODUIT EST CONFORME AUX EXIGENCES DE CONSTRUCTION DU RÉGLEMENT SUR LES PETITS BÂTIMENTS EN VIGUEUR À LA DATE DU DÉBUT DE SA CONSTRUCTION OU DE SON IMPORTATION.</small>	
SAMPLE	

Canadian Compliance Notice - Capacity

CANADIAN COMPLIANCE NOTICE AVIS DE CONFORMITÉ CANADIEN
FOUR WINNS (PFW) CADILLAC, MI, USA MODEL / MODÈLE:
<small>THE MANUFACTURER DECLARES THAT THIS VESSEL COMPLIES WITH THE PLEASURE CRAFT CONSTRUCTION REQUIREMENTS OF THE SMALL VESSEL REGULATIONS, AS THEY READ ON THE DAY ON WHICH THE CONSTRUCTION OF THE VESSEL WAS STARTED OR ON THE DAY ON WHICH IT THE VESSEL WAS IMPORTED. LE FABRICANT ATTESTE QUE CE BÂTIMENT EST CONFORME AUX EXIGENCES DE CONSTRUCTION DES EMBARCATIONS DE PLAISANCE DU RÉGLEMENT SUR LES PETITS BÂTIMENTS, EN VIGUEUR À LA DATE DU DÉBUT DE SA CONSTRUCTION OU À LA DATE DE SON IMPORTATION.</small>
SAMPLE

Canadian Compliance Notice

CE	FOUR WINNS
	SAMPLE - MODEL NAME/YEAR
	MAXIMUM
0609	
C	8  +  = 1134 kg

EU Builders Plate - CE Certification Plate (Export)

A - 1 GENERAL

Before starting the boat, become familiar with all of the various systems and related operations. Be sure all necessary safety equipment is onboard. Know the “Rules of the Road”. Have an experienced operator brief you on the general operation of your new boat. Perform a “Pre-Cruise Systems Check”. This manual is a part of your boat’s equipment. Always keep it on board.

A - 2 COMPONENT SYSTEMS

Before you can really enjoy your boat, a thorough understanding of its systems and their operation is essential. This manual and the associated manufacturer’s information are included in the owner’s packet. This information is provided to enhance your knowledge of the boat. Read this information carefully.

After becoming familiar with the boat and its systems, reread this manual and other material provided in the owner’s packet. Maintenance and service tips are included to help keep the boat in like-new condition.

A - 3 SAFETY EQUIPMENT

Besides the equipment installed on the boat by Four Winns, certain other equipment is required for passenger safety. The “Boating Basics, A Guide to Responsible Boating”, describes the Federal equipment requirements and is included in the owners’ packet. These Federal requirements may also be found on the United States Coast Guard’s website: www.uscgboating.org/safety. Remember that these laws are for your protection and are minimum requirements. Check your local and state regulations, also. More information on safety equipment is provided in Section B.

Items like a sea anchor, working anchor, extra dock lines, flare pistol, a line permanently secured to your ring buoy, etc. could at some time save your passengers lives, or save your boat from damage.

The Coast Guard Auxiliary offers a “Courtesy Examination.” This inspection will confirm the boat is equipped with all of the necessary safety equipment.

A - 4 PASSENGER SAFETY

You are responsible for the safety of your passengers as well as for their behavior while aboard. Make sure:

1. Each passenger is properly instructed in Personal Flotation Device (PFD) use and keeps one within reach in case of emergency. All non-swimmers and children should wear a PFD at all times when underway.
2. Passengers do not sit on gunwales, open decks, elevated pedestal seats or on seat backs when the boat is underway. This could cause them to be thrown overboard during a sudden maneuver.
3. At least one other person knows how to operate the boat in case of an emergency.

A - 5 “RULES OF THE ROAD”

As in driving an automobile, there are a few rules that must be known if safe boating operation is to be maintained. The Coast Guard, Coast Guard Auxiliary, Department of Natural Resources or your local boat club sponsor courses in boat handling, including “rules of the road”. Such courses are strongly recommended. Books on this subject are also available from local libraries.

A - 6 LIGHTNING

When boating, it is important to be aware of the weather around you. When the weather changes for the worse, DO NOT jeopardize your safety by trying to “ride out the storm”. If possible, return to a safe harbor and dock your vessel immediately.

If caught in a storm, seek shelter inside the cabin and wait for the storm to pass. With open bow models, suntops and campers will provide some protection, but should not be relied on if you are able to return to shore. Exercise care when high winds are present!



DO NOT swim or dangle legs or arms into the water during a lightning storm. Stay out of the water!

Lightning will seek a ground when it strikes. Avoid contact with metal parts such as bow rails, control handle, or windshield.



NOTICE: Four Winns boats are not equipped with a lightning protection system.

A - 7 DRUGS AND ALCOHOL

Please keep in mind that along with the fun of boating comes responsibility. As the owner or operator of a pleasure boat, you are obligated (morally and legally) to use good judgement while underway in providing for the safety and well-being of your passengers and other boaters around you.

A common and flagrant violation of good judgement and the law by boaters involves the use of alcohol or drugs. Each year, about half of all accidents involving fatalities involve the use of alcohol or drugs.

It is a federal offense to operate a boat while intoxicated. Criminal penalties may include the termination of operating privileges for up to one year. Many states have passed similar laws.

Alcohol or drugs have an inhibiting effect on the judgement and reaction time of the boat operator and his/her passengers. Heed the advice of experts and statisticians: DO NOT drink or use drugs when operating a boat. NEVER allow an obviously intoxicated person to take the helm.

Have fun in your Four Winns® boat but also, have the good sense to be mentally alert and physically capable of operating the boat in a safe manner.

A - 8 PRE-CRUISE SYSTEM CHECK

Before leaving the dock, the following items should be checked:

A. Before Starting The Engine

1. Check the weather forecast. Determine if the cruise planned can be made safely.
2. Be sure all necessary safety equipment is on board and operative. This includes items such as the running lights, horn, spotlight, life-saving devices, etc.

3. Check the bilge water level and bilge pump operation. Check the engine and drive fluid levels. Look for other signs of potential problems. Check for the scent of fuel fumes.
4. Activate the bilge blower. Check the blower output.



Gasoline vapors can explode resulting injury or death. Before starting the engine, check engine compartment bilge for gasoline or vapors. Operate blower for four minutes and verify blower operation. ALWAYS run the blower when the vessel is operating below cruising speed.

5. Ensure an adequate amount of fuel is on board.
6. Be sure you have sufficient water and other provisions on board for the cruise planned.
7. Leave a written message listing details of the planned cruise with a close friend ashore.

B. After Starting The Engine

1. Visibly check the engine to be sure there are no apparent water or oil leaks.
2. Check the gauges. Make sure the oil pressure, water temperature, voltmeter, etc., are reading normally.
3. Have a safe cruise and enjoy yourself.



Always be sure to raise the anchor and ensure the chain stop is engaged prior to operating your boat. Failure to raise and secure anchor before getting underway could result in damage to boat and even severe injury or death from a rebounding anchor.

A - 9 ENGINE OPERATIONAL PROCEDURES

Notice: Consult engine manual. Additional engine information is located in Prelaunch and Underway section.

A. Before Starting

1. Check the engine compartment for water, gas, and/or oil leaks of any kind. Keep the bilge in a clean condition to prevent blower and bilge pump damage, and fire hazards.
2. Check the fluid levels of the engine oil and power steering system daily. Fill oil or steering fluid as required by the indications on the dip sticks. Refer to your engine manual included in the owner's packet. Follow engine manufacturer's recommendations.

NOTICE

IMPORTANT: Lubrication requirements for catalyzed engines differ from the requirements for non-catalyzed engines. Some marine-grade lubricants contain high levels of phosphorus, which can damage the catalyst system. Although these high phosphorus lubricants may allow acceptable engine performance, exposure over time will damage the catalyst. Catalysts damaged by lubricants containing high levels of phosphorus may not be covered by the engine manufacturer's warranty.

3. Power steering and power trim use automatic transmission fluid. Check the fluid levels in the vertical drive units or transmission as often as practical.
4. Start and operate the bilge blower system for at least four (4) minutes before start-up.
5. Lower the vertical outdrive unit using trim switch making sure the water intakes are under the water.

B. Cold / Warm Engine Start - EFI Engines

1. Move the control handle to neutral detent (idle) position. The position of the control handle is typically in the center or straight up position of the control. See Figure A1. Notice as you push the shifter control to the neutral position you will feel the neutral detent engage thus indicating you are in neutral. Note: A "start-in-neutral-only" feature prevents starting the engine while in gear.



Figure A1: Throttle Control in Neutral Position

2. Turn the key switch to start and hold until engine starts or for no longer than 10 seconds. If engine does not start, let go momentarily, then try again.
3. As soon as engine starts, release key to ON or RUN.

NOTICE

Priming is not necessary for EFI engines. Refer to the engine owner's manual for additional information.

C. Shifting and Control Speed

1. Move shifter control to the neutral detent (idle) position. This will engage neutral start switch and allow engine to start. Move the throttle control to the idle position.

CAUTION

DO NOT shift into FORWARD or REVERSE unless engine is running. Damage to the shift system could result from trying to shift without the engine running. Carefully check function of all control and engine systems before leaving the dock.

2. To go FORWARD - move the shifter control forward.
3. To go in REVERSE - move the shifter control rearward.

NOTICE

DO NOT shift from forward to reverse when the boat is planing.

NOTICE

DO NOT shift if engine speed is over 800 rpm.

4. To go from FORWARD to REVERSE, or REVERSE to FORWARD; always pause at NEUTRAL and allow engine speed to return to idle.
5. After shifting is completed, move the shifter control lever forward or rearward to increase engine speed.

 **WARNING**

Any time the boat is operated, be aware of changes in shift system operation. A sudden increase in shift effort at the remote control handle, or other abnormal operation, indicates a possible problem in the shift system. If this occurs, the following precautions must be taken:

- *With engine running and boat securely tied to the dock, shift drive into forward and reverse to ensure there is gear engagement.*
- *When docking the boat, all docking maneuvers must be performed at slow speed. Pay special attention to other boaters. Passengers should be informed of potential problems and precaution taken.*

If you suspect there is a problem, see your engine manufacturer's authorized service center as soon as possible for proper diagnosis and required service or adjustment. Continued operation could result in damage to the shift mechanism and loss of control.

D. Stopping Engine

1. Move control handle to the NEUTRAL position.
2. Turn ignition key to the OFF position.

NOTICE

DO NOT stop engine at speeds above idle or "speed up" engine while turning off ignition. Engine damage could result.

A - 10 GROUNDING AND TOWING **WARNING**

If the boat should become disabled, or if assisting another craft that is disabled, great care must be taken. The stress applied to a boat during towing may become excessive. Excessive stress can damage the structure of the boat and create a safety hazard for those aboard.

Four Winns® boats are not designed nor intended to be used as a towing vessel. The mooring cleats on Four Winns® boats are not designed or intended to be used for towing purposes. These cleats are specifically designed as mooring cleats for securing the boat to a dock, pier, etc. DO NOT use these fittings for towing or attempting to free a grounded vessel.

Freeing a grounded vessel or towing a boat that is disabled requires specialized equipment and knowledge. Line failure and structural damage caused by improper towing have resulted in fatal injuries. Because of this, Four Winns strongly suggests that these activities be left to those who have the equipment and knowledge such as the US Coast Guard or Sea Tow® to safely accomplish the towing task.

 **CAUTION**

Running aground can cause serious damage to a boat and associated underwater gear. If the boat should become grounded, distribute personal flotation devices and inspect the boat for possible damage. Thoroughly inspect the bilge area for signs of leakage. An experienced service facility should check the hull and underwater gear at the first opportunity. DO NOT continue to use the boat if the condition of the hull or underwater equipment is questionable.

If towing or being towed is absolutely necessary, use the strongest lines available, and attach them to the bow eyes or stern eyes only. Have all passengers slip on life jackets and take a seat in the cabin or other protected area.



Lines can snap or other hardware can be loosened or broken while towing. Under certain conditions, this can cause severe injury or fatality.

A - 11 BOATING EDUCATION

A. Boating Courses

Boating education classes are offered throughout the country. The United States Coast Guard Auxiliary offers free courses on different topics usually during the off-season. The most popular course is the “Boating Skills & Seamanship Course,” and information can be obtained by calling 1 800-336-BOAT (2628) or by visiting their website at: www.boatus.com/courseline.

The United States Power Squadron also offers free courses ranging from basic seamanship to celestial navigation. For information, contact your local Power Squadron, or write: USPS, P.O. Box 30423, Raleigh, NC 27622 or visit their website at: www.usps.org.

The World Wide Web contains many websites devoted to boating and boating safety. One such site is www.discoverboating.com which contains many informative articles and website links for both the new boater as well as the experienced boater alike.

The Canadian Power and Sail Squadron offers seamanship courses. Information may be obtained by visiting their website at www.cps-ecp.ca/.

B. Boating Manuals or Literature

A good source of information is the US Coast Guard’s home study book called “The Skipper’s Course”. This book may be purchased through Superintendent of Documents, US Government Printing Office, Washington, DC 20402, Stock # 050-012-00159-6.

Another good source of boating information is Chapman’s “Piloting, Seamanship and Small Boat Handling”. Also, check the local library or bookstore for additional information on boating.

C. Charts and Maps

US nautical charts are sold throughout the country at Governmental Printing Office stores and other agents. Chart catalogs are available by visiting the National

Oceanic and Atmospheric Administration website at <http://nauticalcharts.noaa.gov/mcd/ccatalogs.htm#state>.

In addition, many federal agencies publish recreational maps, including the US Army Corp of Engineers, the Forest Service, the National Park Service, and the Tennessee Valley Authority.

Addresses of all state boating law administration offices are found in the “Boating Basics, A Guide to Responsible Boating”, included in your owner’s packet. Additional copies may be purchased by contacting the publisher.

D. Laws and Regulations

The US Coast Guard is the authority of the waterways; they are there to help the boating public. State boating regulations are enforced by local authorities. You are subject to marine traffic laws and “Rules of the Road” for both federal and state waterways; you must stop if signaled to do so by enforcement officers, and permit to be boarded if asked.

There are many pamphlets, prepared by the US Coast Guard, available to you. These pamphlets explain “Rules of the Road,” signal lights, buoys, safety, international and inland regulations and other information which goes beyond the scope of this manual. For more information contact your local US Coast Guard Unit or visit the US Power Squadron website at www.usps.org.

A - 12 BOAT OWNER REGISTRATION

Federal and state laws require that every boat equipped with propulsion machinery of any type must be registered in the primary state of usage. Registration numbers and validation stickers must be displayed on the boat according to regulations. In most states, this means registration with the designated state agency. In a few jurisdictions, the Coast Guard retains registration authority. Your dealer will either supply registration forms or tell you where they may be obtained. The registration agency will issue you a certificate that must be carried on board when the boat is in use. Some states require additional registration when an out of state boat is used within their boundaries.

Your boat has a hull identification number (HIN) on the starboard hull at the transom. Figure A2 shows a typical identification number. Use this hull identification number for registration and to identify your boat for warranty service.

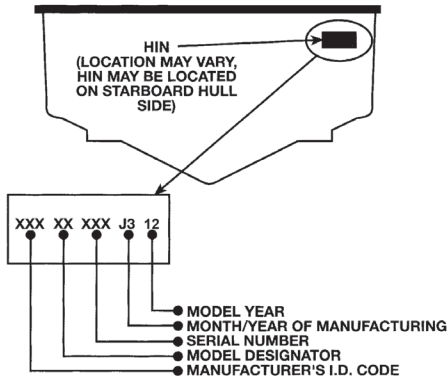

Figure A2: HIN

In most states, the boat owner is legally responsible for damages or injuries he or she causes, even if someone else is operating the boat at the time of the accident. Common sense dictates that you carry adequate personal liability and property damage insurance on your boat, just as you would on an automobile. You should also protect your investment by insuring your boat against physical damage or theft.

A - 13 ACCIDENT REPORTING

The operator of the boat is responsible for filing a report with the appropriate authorities. In general, reports are necessary for accidents involving loss of life, injury, or damage over \$500. In the case of accidents with reportable injuries or death, a formal report is required within 48 hours. If only property damage is involved, a report must be made within ten days. The 1971 Boating Safety Act may impose a \$1,000 civil fine for people who fail to submit a boating accident report. Ask your insurance agent for more information.

If you see a distress signal, you must assume it is a real emergency and render assistance immediately. The master or person in charge of a boat is obligated by law to provide assistance to any individual in danger at sea. However, you should not put your boat or crew in a dangerous situation which exceeds your capabilities or those of your boat. The 1971 Boating Safety Act grants protection to a Good Samaritan boater offering good faith assistance, and absolves a boater from any civil liability arising from assistance given.

A - 14 DISCHARGE OF OIL

The Federal Water Pollution Control Act prohibits the discharge of oil waste into or upon the navigable waters of the United States or the waters of the contiguous zone if such discharge causes a film or sheen upon or a discoloration of the surface of the water or causes a sludge or emulsion beneath the surface of the water. Violators are subject to a penalty of \$5,000.

A - 15 DISPOSAL OF PLASTICS & OTHER GARBAGE

Plastic refuse dumped in the water can kill fish and marine wildlife and can foul boat propellers and cooling water intakes. Other forms of waterborne garbage can litter our beaches and make people sick. US Coast Guard and most state regulations prohibit the dumping of plastic refuse or other garbage mixed with plastic into the water anywhere, and restrict the dumping of other forms of garbage within specified distances from shore.

A - 16 MARPOL TREATY

Boats 26 feet or longer must display a sign stating the disposal regulations of the Federal Water Pollution Control Act. The US Coast Guard has issued these regulations to implement Annex V of the International Convention for the Prevention of Pollution from Ships, 1973, commonly known as Annex V of the MARPOL (Marine Pollution) Treaty 73/78. They apply to all US boats wherever they operate (except waters under the exclusive jurisdiction of a State) and foreign boats operating in US waters out to and including the Exclusive Economic Zone (200 miles). It is important to know these regulations and adhere to them.

The regulations require US recreational boaters, if your boat is 26 feet or more in length, to affix one or more USCG Trash Dumping Restrictions placards to your boat. The placard warns against the discharge of plastic and other forms of garbage within the navigable waters of the United States and specify discharge restrictions beyond the territorial sea. (The territorial sea generally ends three nautical miles from the seashore.) In addition, the placard must contain the warning that a person who violates these requirements is liable to civil (\$25,000) and

criminal (imprisonment) penalties. The placard also must note that State and local regulations may further restrict the disposal of garbage.

Operators shall display one or more placards in a prominent location and in sufficient numbers so they can be observed and read by crew and passengers. These locations might include embarkation points, food service areas, galleys, garbage handling spaces and common deck spaces frequented by crew and passengers. We recommend that these placards may be purchased from local marinas, boat dealerships and marine equipment suppliers. A special placard is available for boats operating on the Great Lakes.

NOTICE

IMPORTANT: It is illegal to discharge waste from your marine sanitary device (toilet) into the water in most areas. It is your responsibility to be aware of and adhere to all local laws concerning waste discharge. Consult with the Coast Guard, local marina or your dealer for additional information.

NOTICE

NOTE: Some states and localities have legal limits on speed, noise and trailer specifications. It is your responsibility to be aware of these laws and limits and to insure that your boat (and trailer) comply. Consult with your local Marine Patrol or local Coast Guard office.



B - 1 GENERAL

As the owner/operator of the boat, you are responsible for assuring that all required safety equipment is aboard. You should also consider supplying additional equipment as needed for your safety and that of your passengers. Check state and local regulations and visit the US Coast Guard's Office of Boating Safety website at www.uscgboating.org for information about required safety equipment. Also visit the United Power Squadron website at www.usps.org.

A. Required Safety Equipment

Most of the safety equipment required by federal regulations is provided as standard equipment. Personal Flotation Devices (life jackets) must fit the persons wearing them. Minimum requirements include the following:

- Personal Flotation Devices
- Visual Distress Signal
- Bell or Whistle
- Fire Extinguisher
- Navigation Lights

NOTICE

As the owner/operator of the boat, you are responsible for assuring that all required safety equipment is aboard and meets the boating regulations as prescribed by both federal and local authorities in your area.

B. Personal Flotation Devices (PFDs)

Federal regulations require that you have at least one Coast Guard approved personal flotation device (PFD) for each person in a recreational boat. You should not use your boat unless all PFDs are in serviceable condition, readily accessible, legibly marked with the Coast Guard approval number, of an appropriate size (within the weight range and chest size marked on the PFD) for each person aboard.

A PFD provides buoyancy to help keep your head above the water and to help you remain in a satisfactory position while in the water. Body weight and age should be considered when selecting a PFD. The buoyancy provided by the PFD should support your weight in water.

The size of the PFD must be appropriate for the wearer. Body weight or chest size are common methods

used to size PFDs. It is your responsibility to ensure that you have the proper number and types of PFDs on board and that your passengers know where and how to use them.

C. PFD Types

Five types of PFDs have been approved by the US Coast Guard. The PFDs are described as follows:

PFD Type 1, Wearable (Figure B1) has the greatest required buoyancy. Its design allows for turning most unconscious persons in the water from face down position to a vertical or slightly backward, face-up position. It can greatly increase the chances of survival. Type 1 is most effective for all waters, especially offshore when rescue may be delayed. It is also the most effective in rough waters.



Figure B1: Type I, Wearable

PFD Type II, Wearable (Figure B2) turns its wearer in the same way as Type I, but not as effectively. The Type II does not turn as many persons under the same conditions as a Type I. You may prefer to use this PFD where there is a probability of quick rescue such as in areas where other people are commonly involved in water activities.



Figure B2: Type II, Wearable

PFD Type III, Wearable (Figure B3) allows the wearer to place themselves in a vertical or slightly backward position. It does not turn the wearer. It maintains the wearer in a vertical or slightly backward position and has no tendency to turn the wearer face down. It has the same buoyancy as a Type II PFD and may be appropriate in areas where other people are commonly involved in water activities.



Figure B3: Type III, Wearable

PFD Type IV, Throwable (Figure B4) is required in addition to the PFDs previously discussed. The most common Type IV PFD is a buoyant cushion or ring buoy. It is designed to be thrown to a person in the water, grasped and held by the user until he or she is rescued. A Type IV PFD should always be in serviceable condition and immediately available for use. Grasping this PFD may be difficult if the rescue is delayed or if the user is overcome by hypothermia (loss of body heat).

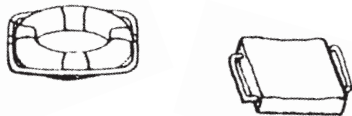

Figure B4: Type IV, Throwable

PFD Type V, Wearable (Figure B5) when inflated, it provides buoyancy equivalent to Type I, II, or III PFDs. When it is deflated, however, it may not support some people.



Figure B5: Type V, Wearable

D. PFD Pointers

The purpose of a PFD is to help save your life. If you want it to support you when you are in the water, it needs to fit, float, and be in good condition.

1. Try the PFD on and adjust it until it fits comfortably in and out of the water. Mark your PFD if you are the only wearer.
2. To make sure the PFD works, wear it in the water. This will show you how it works and give you confidence when you use it.

3. Teach children how to put a PFD on and allow them to try it in the water. That way, they know what the PFD is for and how it works. They will feel more comfortable with it if they suddenly find themselves in the water.
4. If the PFD is wet, allow it to dry thoroughly before storing it. Do not dry it in front of a radiator or heater. Store it in a well ventilated area.
5. Keep PFDs away from sharp objects which can tear the fabric or puncture the flotation pads.
6. For their own safety and the safety of others, all non swimmers, poor swimmers, and small children should wear PFDs at all times, whether the boat is stationary or moving.
7. Check the PFD frequently to make sure that it is not torn, that flotation pads have no leaks, and that all seams and joints are securely sewn.
8. If a PFD contains kapok, the kapok fibers may become waterlogged and lose their buoyancy after the vinyl inserts are punctured. If the kapok becomes hard or if it is soaked with water, replace it. It may not work when you need it.

E. Fire Extinguisher

As the owner/operator of the boat, you are responsible for supplying a fire extinguisher approved by the US Coast Guard.

Hand-held portable extinguisher(s) should be mounted in a readily accessible location(s) away from the engine compartment. All persons aboard should know the location(s) and proper operation of the fire extinguisher(s).



FIRE

In case of fire do not open the engine compartment. Shut down engine(s), generator(s), and blower(s). Discharge entire contents of fixed fire suppression system, if equipped. If using a portable CO2 fire extinguisher, continuously discharge entire contents. On export models, discharge contents through fire port.

NOTICE

Using a portable fire extinguisher with an access/fire port in the engine compartment is preferred to opening the engine compartment to fight the fire. However, using a portable extinguisher in this way provides less protection against fire than a fixed suppression system.

NOTICE

Do not test fire extinguishers by squirting small amounts of the extinguishing compound. The fire extinguisher might not work when you really need it.

Four Winns sport boat and deck boat models are considered to be Class 1 powerboats (16 to less than 26 feet). Since they have permanently-installed fuel tanks, they are required to carry one (1) B-I type hand-held portable fire extinguisher. If the boat is equipped with a fixed fire extinguishing system in the engine compartment, one (1) B-I type hand-held portable fire extinguisher is still required.

Sport boats and deck boats that are Class 2 powerboats (26 to less than 40 feet) are required to carry two (2) B-I type approved hand-held portable fire extinguishers or one (1) B-II type approved hand portable fire extinguisher. When a fixed fire extinguishing system is installed in machinery space(s), at least one (1) B-I type approved hand portable fire extinguisher is required.

An automatic fire extinguisher system is available on certain boat models. The type of extinguishing agent used may vary. The equipment utilized has been so chosen, and located, to provide sufficient volume and coverage of the entire engine compartment. While the system ensures excellent overall bilge fire protection, **it does not eliminate the USCG requirement for hand-held fire extinguishers.** Refer to the extinguisher manufacturer's literature included in the owner's packet.

F. Visual Distress Signal Devices

Visual distress signal devices approved by the US Coast Guard are required on all recreational boats operating on coastal waters and to boats owned in the United States when they are operating on the high seas. Coastal waters include territorial seas and those waters directly connected to the Great Lakes and the territorial seas up to a point where the waters are less than two miles (3.2km) wide. Visual distress signal equipment may be of the pyrotechnic

or non-pyrotechnic type. Regulations prohibit display of visual distress signals on the water under any circumstances except when assistance is required to prevent immediate or potential danger to persons on board a vessel.

The equipment must be approved by the US Coast Guard, be in serviceable condition, and be stowed in a readily accessible location. Equipment having a date for serviceable life must be within the specified usage date shown. Careful selection and proper stowage of visual distress equipment is very important if young children are aboard.

DAY USE ONLY	NIGHT USE ONLY	DAY AND NIGHT USE
Three orange smoke signals (one hand held and two floating) or one orange flag with black square and disk.	One S-O-S electric distress light.	Three flares of the hand held, meteor or parachute type.

Distress Signal Table

The minimum visual distress signals required in coastal waters for a Class 1 or Class 2 powerboat is the following:

One orange flag with black square and disc (daytime); and an S-O-S electric light (nighttime); or three orange smoke signals, hand-held or floating (daytime); or three red flares of hand-held, meteor, or parachute type (daytime/nighttime).

NOTICE

No single signaling device is appropriate for all purposes. Consider keeping various types of equipment on board.

G. Sound Signaling Devices

Class 1 and Class 2 powerboats are required to carry a hand, mouth or power operated horn or whistle. It must produce a blast of two-second duration and audible at a distance of at least one-half (1/2) mile.

The following are standard whistle signals:

- One Prolonged Blast = Warning Signal
- One Short Blast = Pass on my Port Side
- Two Short Blasts = Pass on my Starboard Side
- Three Short Blasts = Engines in Reverse
- Five or More Blasts = Danger Signal

H. Navigation Lights

Navigation lights are intended to keep other vessels informed of your presence and course. If you are out on the water between sunset and sunrise, you are required to display appropriate navigation lights.

I. Additional Recommended Equipment

Four Winns® recommends that you acquire additional equipment for safe, enjoyable cruising. This list, while not all-inclusive, suggests items you should consider acquiring.

Basic Gear

Flashlight	Spare batteries	Tow line
Oar, paddle	Mooring lines	Compass
Dock fenders	Distress signals	First aid kit
Boat hook	VHF radio	EPIRB*
Sunscreen	Extra warm clothing	Charts
Second anchor & line		
Dewatering device (pump or bailer)		
Emergency supply of drinking water and food		
<u>*Emergency Position Indicating Radio Beacon</u>		

Tools

Spark plug wrench	Hammer	Screwdriver
Jackknife	Pliers	
Electrical tape	Duct tape	
Adjustable wrench	Lubricating oil	Prop wrench

Spare Parts

Extra bulbs	Spare prop	Extra fuses
Extra drain plug	Spark plugs	Spare wire
Extra prop nut/washer		

Gear For Extended Cruises

Foul weather gear	Parallel rulers	Dividers
Global Positioning System navigation equipment		

B - 2 CARBON MONOXIDE



CARBON MONOXIDE!

Carbon monoxide (CO) can be harmful or fatal if inhaled. Brain damage or death can result from prolonged exposure to carbon monoxide. Keep exhaust outlets clear of blockage. Provide adequate ventilation. Open hatches, doors, windows and vents to insure adequate ventilation. Close engine compartment doors and hatches when engine or generator is running. Avoid operating the boat for extended periods of time at idle speed, and be sensitive to weather conditions that may prevent CO from dissipating into the air. Do not stand or swim near engine or generator exhausts when engines are running.

Carbon monoxide accumulation is affected by many variables (e.g., boat geometry, hatch, window and door opening, ventilation openings, proximity to other structures, swim platforms, canvas enclosures, location of exhaust outlets, vessel attitude, wind direction, vessel speed, boat systems maintenance, etc.) The technical information included in this section is to inform the boat owner of possible cause and effects of carbon monoxide exposure. This information has been reprinted with permission from the American Boat and Yacht Council's (ABYC) technical information report: "[Educational Information About Carbon Monoxide](#)". This information pertains to all gasoline-powered boats manufactured by Four Winns.

NOTICE

The boat owner should be aware that other factors may contribute to carbon monoxide accumulation. The most common ones are listed in this section. If a person is exhibiting carbon monoxide-type symptoms (Refer to B-2E Symptoms), be sure to take the necessary precautions as prescribed later in this section.

NOTICE

Boats fueled by diesel have limited carbon monoxide present in the exhaust in comparison to gasoline engine exhaust. However, the boat owner should still be aware of the causes and effects of carbon monoxide which may occur in different boating situations.

A. Properties and Characteristics of Carbon Monoxide

1. Carbon monoxide is a colorless, odorless and tasteless gas. It is commonly referred to as CO.
2. Its weight is about the same as air so it cannot be expected to rise or fall like some other gases, but will distribute itself throughout the space.

NOTICE

DO NOT rely on the use of smell or sight of other gases to detect CO, because it diffuses in the air much more rapidly than easily detectable vapors (i.e., visible and aromatic vapors).

B. What Makes Carbon Monoxide

Any time a material containing carbon burns such as gasoline, natural gas, oil, propane, coal, or wood, CO is produced.

Common sources of carbon monoxide are:

1. Internal combustion engines such as:
 - a. Propulsion engines
 - b. Generators
2. Open flame devices such as:
 - a. Cooking ranges
 - b. Central heating plants
 - c. Space heaters
 - d. Water heaters
 - e. Fireplaces
 - f. Charcoal grills

C. How a Person is Affected by Carbon Monoxide

Carbon monoxide is absorbed by the lungs and reacts with blood hemoglobin to form carboxyhemoglobin, which reduces the oxygen carrying capacity of the blood. The result is a lack of oxygen for the tissues with the subsequent tissue death and, **if exposure is prolonged, death of the individual.**

D. Effects of Carbon Monoxide

Carbon monoxide in high concentrations can be fatal in a matter of minutes. Lower concentrations must not be ignored because the effects of exposure to CO are cumulative and can be just as lethal.

Certain health related problems and age will increase the effects of CO. People who smoke or are exposed to high concentrations of cigarette smoke, consume alcohol or have lung disorders or heart problems, are particularly susceptible to an increase in the effects from CO; however, all occupants' health should be considered. Physical exertion accelerates the rate at which the blood absorbs CO.

E. Symptoms

One or more of the following symptoms can signal the adverse effect of CO accumulation:

1. Watering and itchy eyes
2. Flushed appearance
3. Throbbing temples
4. Inattentiveness
5. Inability to think coherently
6. Loss of physical coordination
7. Ringing in the ears
8. Tightness across the chest
9. Headache
10. Drowsiness
11. Incoherence
12. Slurred speech
13. Nausea
14. Dizziness
15. Fatigue
16. Vomiting
17. Collapse
18. Convulsions

NOTICE

The order of the above list is generally the sequence of appearance of symptoms. However, the order of appearance may change for different people.

NOTICE

The symptoms of carbon monoxide poisoning may easily be mistaken for seasickness or alcohol intake.

F. Treatment (Evaluate, Ventilate, Evacuate, Investigate, Take Corrective Action)

1. Evaluate the situation and ventilate the area if possible.
2. Evacuate the area and move affected person(s) to a fresh air environment.

3. Observe the victim(s).
4. Administer oxygen if available.
5. Contact medical help. If the victim is not breathing, perform rescue breathing or approved cardiopulmonary resuscitation (CPR), as appropriate, until medical help arrives and takes over.
6. Investigate source of CO and take corrective action.

NOTICE

Prompt action can make the difference between life and death.

G. Inspection

Look and listen for leaks in the exhaust systems of both the generator (if applicable) and propulsion engine(s). Look for discoloration around joints in the system (water leaks, carbon, stains, etc.).

1. Make sure all exhaust clamps are in place and secured.
2. Make sure ventilation systems work and are not obstructed or restricted.
3. Make sure gaps around the engine room plumbing and cableways and exhaust system doors, hatches, and access panels are minimized to reduce the opportunity for CO to enter the accommodation space(s).

H. Operation

Cold Start vs. Warm Start: CO production is greater while the combustion chamber surfaces and gas passages are cold versus when they are warm. A boat operator should:

1. Pay attention to ventilating the boat.
2. Orient the boat so it will allow the maximum dissipation of CO.
3. Minimize the time spent on getting underway.
4. In order to minimize CO buildup, do not warm up or run propulsion engine(s) for extended periods while the vessel is stationary.

WARNING

*The following are examples of possible situations where carbon monoxide can accumulate within your boat while docked, anchored, or underway. Become familiar with these examples and their precautions to prevent **dangerous** accidents or death.*

I. Boathouses, Sea Walls and Confined Spaces

A boat operator should be aware that dangerous concentrations of CO can accumulate when a boat, generator or other engine operated device is operated while the boat is moored in a confined area such as:

1. Boathouses,
2. Proximity to sea walls, or
3. Proximity to other boats.

Keep engine room hatches and doors closed when operating engines, including the generator (if applicable).

Pay attention to prevailing conditions and provide for ventilation to induce fresh air and minimize exhaust re-entry. Orient the boat for maximum dissipation of the exhaust. **DO NOT** run the boat or boat equipment for extended periods under these conditions. See Figure B6.

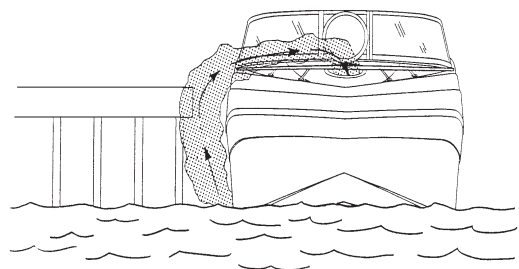

Figure B6: Minimize Exhaust Re-enty

Be aware that cockpit and deck drains can be a source of CO ingress into boats, especially boats with cockpit or decks enclosed with canvas or permanent boat structures.

J. The Effect of Boats Moored Along Side

A boat operator should be aware that carbon monoxide is emitted from any boat's exhaust. The operation, mooring, and anchoring in an area containing other boats may be in an atmosphere containing CO not of the operator's making. An operator likewise needs to be aware of the effect of their boat on other boats in the area. Of prime concern is the operation of an auxiliary generator where boats are moored along side each other. Be aware of the effect your exhaust may have on other boats and be aware that the operation of other boats' equipment may affect the carbon monoxide concentration on your boat. See Figure B7.

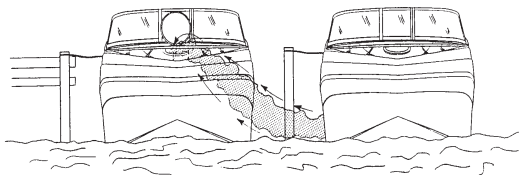

Figure B7: The effect of boats moored along side

K. Backdrafting (Station Wagon Effect)

Backdrafting or the "station wagon effect" is caused by air movement over or around a boat creating a low pressure area or suction area around the stern that can increase CO level on the boat. Backdrafting can be affected by relative wind direction, boat speed, and boat trim angle. See Figure B8 Backdrafting – Airflows Over Boat and Behind Transom".

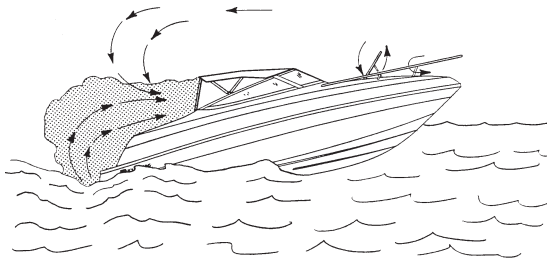

Figure B8: Backdrafting - Air flows over boat and behind transom

Under certain speed and operating conditions, the low pressure area may form in other regions and permit carbon monoxide to enter the hull through openings that are not on the back of the boat. Boat factors which may affect CO concentration:

1. Intentional or unintentional excessive trim angle causing high bow angle. See Figure B9.

2. Excessive or unequally distributed weight.

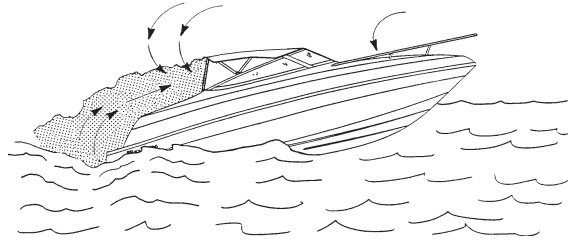

Figure B9: Inefficient trim angles

3. Canvas configurations – Under various conditions, adding or removing canvas may raise or lower CO levels. See Figures B8, B9 & B11.



EXHAUST FUMES!

Hull exhaust from your boat can cause excessive accumulation of poisonous carbon monoxide gas within cockpit areas when using protective weather coverings (while underway or while stationary). Provide adequate ventilation when the canvas top, side curtains and/or back (aft) curtains are in their closed protective positions.

4. Opening and closing ports, hatches, doors, and windows may raise or lower CO levels on board a boat. When airflow is moving forward inside the boat, CO may be entering the boat. See Figures B10 and B11.

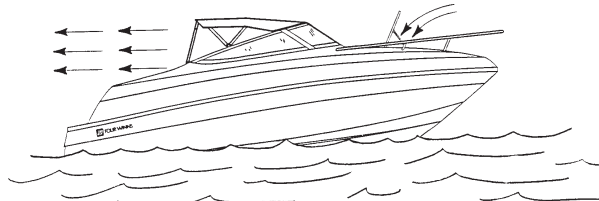

Figure B10: Desired air flow through the boat

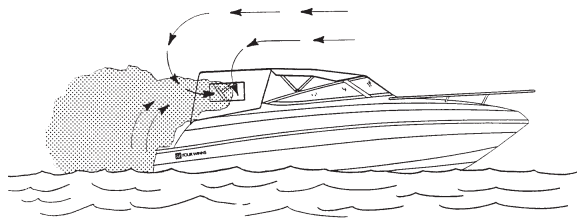

Figure B11: The effect of canvas configurations

5. Operating a boat at slow speeds with a following wind should be avoided. Consider changing direction, adjusting speed, or both. See Figure B12.

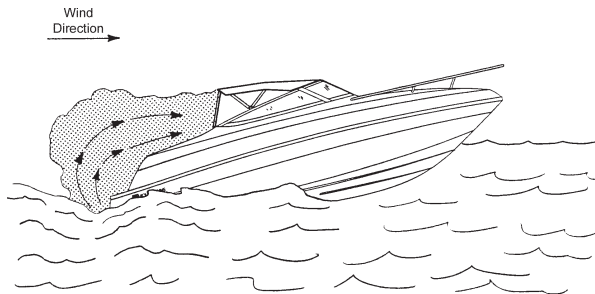

Figure B12: Operating at Slow Speed with Following Wind

6. Be aware that cockpit and deck drains can be a source of CO ingress into boats, especially boats with cockpit or decks enclosed with canvas or permanent boat structures.

L. Accumulation of Exhaust Gases - Swim Platform

When the propulsion engine(s) or generator is running, CO is produced and may remain in the vicinity of the exhaust outlet (including underwater exhaust outlets).

1. Do not occupy aft lounging area(s) or swim platform.
2. Do not swim under or around swim platform.
3. Do not swim in the vicinity of the exhaust outlet.

Refer to Figure B13.

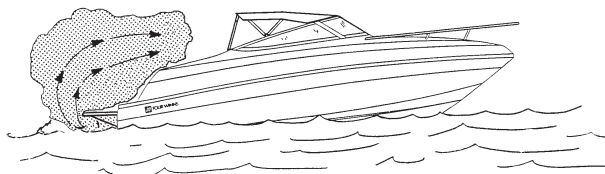

Figure B13: Exhaust Gas Accumulation at Swim Platform

M. Dangerous Activity - “Teak Surfing”/“Dragging”

Do not sit on, occupy or hang on any stern appendages (e.g., swim platforms, boarding ladders, etc.) while underway. Do not body surf, commonly known as “teak surfing” or “dragging”, etc., in the wake of the boat. Do not tow persons in close proximity to the stern of the boat. See Figure B14. This activity can also increase the possibility of injury due to contact with a rotating propeller.

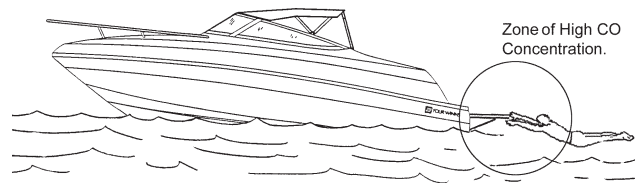

Figure B14: Exhaust Gas Accumulation - Dangerous Activity

N. Cabin Appliances

Boats having fuel burning appliances in accommodation areas should be provided with adequate ventilation and the appliance should be maintained to function properly.

O. Air Conditioning (Applicable Models Only)

Lack of system maintenance may cause CO to be brought into the air-conditioned spaces by the air conditioner. If applicable, please refer to the air conditioner manufacturer’s literature for additional information. Please consult with your Four Winns Dealer regarding availability.

P. Ventilation of Accommodation (Occupied) Spaces

Accommodation spaces need to be ventilated to introduce fresh air into the spaces. Ventilation methods (e.g., windows, hatches, doors, and blowers) used to accomplish this may, under certain conditions, bring hazardous levels of CO into the occupied spaces. Care should be taken to be aware of all prevailing conditions when using these ventilating methods.

Q. Running of Engines in Idle

Engines running in idle exhaust carbon monoxide that can accumulate near the hull of the boat. Do not stand or swim near the engine exhaust or outdrive when engines are idling or generator is running.

R. Altitude and Sea Conditions

Operation at altitudes greater than 5,000 feet contributes to inefficient engine performance and may require adjustments to the ignition systems, fuel systems, or changing the propeller’s size or gear ratio.

1. Failure to make adjustments to ignition systems and/or fuel systems for altitude conditions may cause an increase in CO production.

2. Reduced power resulting from increased altitude may require adjustments to propeller size.
3. Heavy sea or out of trim conditions tend to load engines resulting in reduced performance and thereby increasing their CO production.

S. Portable Generator Sets



Never use a portable generator on a boat.

Gasoline-powered portable generators are available in the marine market place and are not an option available through Four Winns. Portable generators will produce CO. These sets discharge their exhaust products in locations which can lead to an increase in the accumulation of carbon monoxide in the accommodation occupied space. **Do not use gasoline-powered portable generators on Four Winns® boats.**

T. Maintenance - Engine Performance

Efficient engine performance is vital to minimizing CO production. The following items are those considered to have the greatest effect on increased CO production:

1. Fuel Systems - Fuel that is contaminated, stale or incorrect octane number
2. Carburetors/Injectors
 - a. Dirty or clogged flame arrester
 - b. Malfunctioning automatic choke plate or faulty adjustment of manual choke plate
 - c. Worn float needle valve and seat
 - d. High float level
 - e. Incorrect idle mixture adjustment
 - f. Dirty or worn injectors
3. Ignition System
 - a. Fouled or worn spark plug.
 - b. Worn points or incorrect gap on points

- c. Shorted or opened circuit high tension spark plug cables
- d. Incorrect ignition timing.

4. General

- a. Worn piston rings and valves
- b. Engine temperature - Cold running engines increase CO production. Engine cooling water system design and selection of thermostat(s) are primary considerations affecting engine operating temperature. Generally, an engine produces less CO if it operates at a relatively high temperature within manufacturer's specifications.
- c. Exhaust Back-Pressure - Certain alterations to the exhaust system may increase engine exhaust back pressure and CO production.
- d. Restricted engine room or compartment ventilation

U. Maintenance - External Conditions

External conditions that contribute to inefficient engine performance can include:

1. Fouled hull bottom
2. Damaged and fouled running gear (i.e., outdrive shaft, strut propeller, rudder and trim tabs, if applicable)
3. Incorrect selection of propeller size

V. Maintenance - Exhaust System Integrity

Gas tight integrity of exhaust systems must be maintained to insure that leakage of CO within the boat does not occur. Disassembly may be required to carry out a thorough inspection. Repair or replace components as indicated. Inspect the following:

1. Gaskets at cylinder head connection
2. Casting and pipe fittings in the dry section
3. All joints
4. Hoses
5. Clamps
6. Mufflers and their drain plugs
7. Thru-hull fittings
8. Hangers and other supports

W. Maintenance - Ventilation Systems

Boats are equipped with ventilation systems to eliminate gasoline vapors. Blowers and fans may also be provided for ventilation and to mitigate the migration of CO into occupied compartments. Attention should be paid to the following:

1. Keeping ventilation intakes clear of debris
2. Replacing damaged hardware
3. Maintaining the integrity of the duct material and its connections
4. Ensuring the position of duct intakes are not obstructed or restricted, collapsed, kinked, or crushed
5. Eliminating sags in ducts that can form a water trap
6. Checking hangers and other supports
7. Ensuring blower/fan is operational
8. Ensuring that airflow is present at discharge
9. Inspecting wiring to equipment

X. Maintenance - Bulkhead and Deck Integrity

1. Seal all visible openings (e.g., cracks, crevices, holes, including openings around wiring and piping runs) in bulkheads and decks that separate machinery compartments from occupied compartments. These openings can permit migration of CO vapors.
2. Check gaskets and sealing surfaces on hatches, doors, and access panels.

Y. Maintenance - Air Conditioning Systems (Applicable Models Only)

These systems can be a source of CO ingress and migration of CO vapors.

1. Keep grilles and filters clean.
2. Seal bulkhead voids and openings at wiring and piping runs in return air ducts, plenums, and air handling equipment enclosures, especially those adjacent to machinery compartment bulkheads.
3. Check that water traps and condensate drains are present. These may be in the form of a double loop in the drain line or prefabricated p-traps. Any drain that discharges below the waterline when the boat is underway is sealed, by virtue of its design, against CO intrusion.

Z. Maintenance - Liquid Drains

Sink, shower and condensate drains can be a source of CO ingress. Ensure that water traps are present and contain fluid. These traps may be in the form of a double loop in the drain line or prefabricated p-traps. Any drain that terminates below the waterline is, by virtue of its design, sealed against CO intrusion. Some drains that are below the waterline when boat is underway will be above the waterline when the boat is at rest. The location of drains, relative to the waterline, can be affected by the dynamics of boat motion (i.e., underway or at rest).

AA. Carbon Monoxide Monitor - (Applicable Models Only)

Four Winns has installed a CO monitor in models equipped with a cabin. This piece of safety equipment could mean the difference between life and death. Check monitor and maintain in accordance with the manufacturer's instructions.

⚠ WARNING

Never disarm a CO detector. If a CO detector alarms, immediately ventilate the area and check passengers for symptoms of CO intoxication. See your Four Winns dealer for assistance in diagnosing the cause for the alarm.

NOTICE

For information on CO Detection Systems, see American Boat and Yacht Council (ABYC Manual) Section A-24, "Carbon Monoxide Detectors".

Even with the best of boat design and construction along with the utmost care in inspection, operation, and maintenance of boat systems, hazardous levels of CO may still be present in accommodation spaces and exterior areas under certain conditions. Vigilant observation of passengers for CO sickness symptoms should be supplemented by a marine CO detection device in the accommodation space.

⚠ WARNING

A CO detector is not a gas/fuel vapor detector. Gas/fuel vapor detectors do not monitor the buildup of carbon monoxide in an enclosed area. For further information on the design, construction, and testing of boats in consideration of carbon monoxide, see ABYC TH-23.

NOTICE

Detection devices shall meet the requirements of ABYC A-24 "Carbon Monoxide Detection Systems on Boats".

B - 3 SAFE BOATING PRACTICES**NOTICE**

YOU are responsible for your own safety, the safety of your passengers, and the safety of fellow boaters.

A. Drugs and Alcohol**⚠ WARNING**

Alcohol consumption and boating do not mix! Operating under the influence endangers the lives of your passengers and other boaters. Federal laws prohibit operating a boat under the influence of alcohol or drugs.

Do not use drugs or drink alcohol while operating a boat. Like driving a car, driving a boat requires sober, attentive care. Operating a boat while intoxicated or under the influence of drugs is not only dangerous, but it is also a Federal offense carrying a significant penalty. These laws are vigorously enforced. The use of drugs and alcohol, singly or in combination, decreases reaction time, impedes judgement, impairs vision, and inhibits your ability to operate a boat.

B. Safe Operation

Safe operation means that you do not misuse your boat nor do you allow your passengers to do so. Safe operation means using good judgement at all times. It includes, without limitation, the following actions:

- Observe all safety signs and warnings both inside the boat and in the immediate boating area.
- Become familiar with and adhere to the "Rules of the Road".
- Maintain boat speed at or below the legal limits. Avoid excessive speed or speeds not appropriate for operating conditions.
- Be sure at least one other passenger is familiar with the operation and the safety aspects of the boat in case of an emergency, and knows how to use and locate all safety equipment.
- Load the boat within the limits listed on the capacity plate. Balance loads bow and stern and port to starboard. Passengers are to sit only on seats, not seat backs, gunwales, engine cover, or any other unsafe locations.
- Do not use the boat in bad weather or sea conditions beyond the skill or experience of the operator or the comfortable capability of the boat or passengers.

- Make sure the passengers and gear do not obstruct the operator's view or impede his ability to move.
- Do not exceed the maximum engine power rating stated on the certification plate located inside the boat.

C. Passenger Safety

Before getting underway, show all passengers where emergency and safety equipment is stowed, and explain how to use it. Everyone aboard should wear rubber-soled shoes which resist slipping on wet surfaces. While underway, passengers should remain seated inside the deck rails and gates. Do not allow passengers to drag their feet or hands in the water. Always use hand holds and other safety hardware to prevent falls. All non swimmers, poor swimmers and small children should wear PFDs at all times.

D. Propeller



PERSONAL INJURY

Do not allow anyone near a propeller, even when the engine is off. Propeller blades can be sharp and continue to turn even after the engine is shut off. Do not allow anyone near the propeller when the throttle is in neutral position. Accidentally engaging the shift can result in a serious injury or death. (See actual ladder warning labels and helm boarding ladder warning label below).



Never approach or use ladder when motor is running. Severe injury or death will result from contact with rotating propeller.

Ladder Warning Label



Shut off motor when near swimmers. Severe injury or death will result from contact with rotating propeller.

Helm Boarding Ladder Warning Label



When pulling skiers do not turn on the engine until you are at least a boat length away from the person in the water. When approaching a downed skier, turn off the engine at least one boat length away before reaching the skier in the water.

E. First Aid

As a boater, you should be familiar with the basic first aid procedures that may be needed while you are out far from help. Fish hook accidents or minor cuts and abrasions may be the most serious mishaps on board a boat but you should also learn the proper procedures and be ready to deal with the truly serious problems like mouth-to-mouth resuscitation, excessive bleeding, hypothermia, and burns. First aid literature and courses are available through most Red Cross chapters.

F. Operation By Minors

Minors should always be supervised by an adult whenever operating a boat. Many states have laws regarding the minimum age and licensing requirements of minors. Be sure to check local laws or contact the state boating authorities for information.

G. "Rules of the Road"

As a responsible boater, you must comply with the "Rules of the Road," the marine traffic laws enforced by the US Coast Guard. Navigating a boat is much the same as driving an automobile. Operating either one responsibly means complying with a set of rules intended to prevent accidents. Just as you assume other car drivers know what they are doing, other boaters assume you know what you are doing. Information regarding navigational rules and the "Rules of the Road" are discussed in further detail in C-1 & C-2 of the next section.

H. Voluntary Inspections

State boating officials in many states or the US Coast Guard Auxiliaries offer courtesy inspections to check out your craft. They will check for compliance with safety standards and required safety equipment. You may voluntarily consent to one of these inspections, and you are allowed to make corrections without prosecution. Check with the appropriate state agency or the Coast Guard Auxiliary for details.

I. Safe Boating Courses

The local US Coast Guard Auxiliary and the US Power Squadrons offer comprehensive safe boating classes several times a year. You may contact the Boat/U.S. Foundation at 1-800-336-BOAT (2628) for a course scheduled in your area. Also contact the US Coast Guard Auxiliary or Power Squadron Flotilla for the time and place of their next scheduled class.

B - 4 WATER SPORTS



PERSONAL INJURY

Four Winns® boats are not designed for and should not be used for pulling parasails, kites, gliders or any device which can become airborne. Use boat only for appropriate water sports. (See Preface for actual warning label).

Water skiing, wakeboarding, kneeboarding, or riding a towed, inflatable apparatus are some of the more popular water sports. Taking part in any water sport requires increased safety awareness by the participant and the boat operator. If you have never pulled someone behind your boat before, it is a good idea to spend some hours as an observer, working with and learning from an experienced driver. It is also important to be aware of the skill and experience of the person being pulled. Always have a second person on board to observe the person in the water so the driver can concentrate on operating the boat.

A. Water Sport Guidelines

Everyone participating in a water sport should observe these guidelines:

1. Allow only capable swimmers to take part in any water sport.
2. Always wear a personal flotation device (PFD) approved by the US Coast Guard. Wearing a properly designed PFD helps a stunned or unconscious person stay afloat.
3. Be considerate of others with whom you share the water.
4. Give immediate attention to a person who has fallen. He or she is vulnerable in the water alone and may not be seen by other boaters.

5. Approach a person in the water from the lee side (opposite the direction of the wind). **Turn off the motor at least a boat length from the person.**
6. Turn engine off and anchor before swimming.
7. Always participate in water sports in safe areas. Stay away from other boats, beaches, restricted areas, swimmers and heavily traveled waterways.
8. Swim only in areas designated as safe for swimming. These are usually marked with a swim area buoy (see Figure B15). Do not swim alone or at night.



Figure B15: Swim Area Buoy



Rotating Propeller!

Rotating propeller can cut or sever causing serious injury or death. Shut engine off and remove ignition key when anyone is swimming nearby. (See Section B-3D).

9. Do not allow anyone near the propeller(s), even when the engine is off. Propeller blades are sharp and can continue to turn even after the engine is off. Stay at least 150 feet away from areas marked by diver down float. See Figure B16.



Figure B16: Diver Down Float

10. Do not drive the boat directly behind a water skier. At 25 miles per hour, the boat will overtake a fallen skier who was 200 feet in front in about 5 seconds.

B. Water Skiing/Wakeboarding/Kneeboarding

The popular sport of water skiing has brought a special set of safety precautions to observe in boating. The following guides help prevent accidents while water skiing.

1. Water ski only in safe areas, away from other boats and swimmers, out of channels, and in water free of underwater obstructions.
2. Allow no one who can not swim to water ski. Skiers must wear a USCG approved flotation device. A Type III water-ski vest is an approved and practical PFD.
3. Have a second person aboard to observe the skier and inform the driver about the skier's hand signals (Figure B17). The driver must give full attention to operating the boat and the waters ahead.
4. Give immediate attention to a fallen skier. Be careful not to swamp the boat while taking the skier on board.
5. Always participate in water sports in safe areas. Stay away from other boats, beaches, swimmers, and heavily traveled waterways.
6. Be considerate of others with whom you share the water.

7. Give immediate attention to a person who has fallen. He or she is vulnerable in the water alone and may not be seen by other boaters.
8. Approach a person in the water from the lee side (opposite the direction of the wind). Stop the motor at least a boat length from the person.
9. Turn off engine and anchor your boat before swimming.



Rotating Propeller!

Rotating propeller can cut or sever causing serious injury or death. Switch engine off before skiers enter the water and before taking skiers aboard. Do not leave engine running in neutral. Accidentally engaging shift can seriously injure skier.

10. Do not water ski between sunset and sunrise. It is illegal in most states.

For more information about waterskiing, wakeboarding, and/or kneeboarding, please visit the American Water Ski Association, at their website: www.usawaterski.org

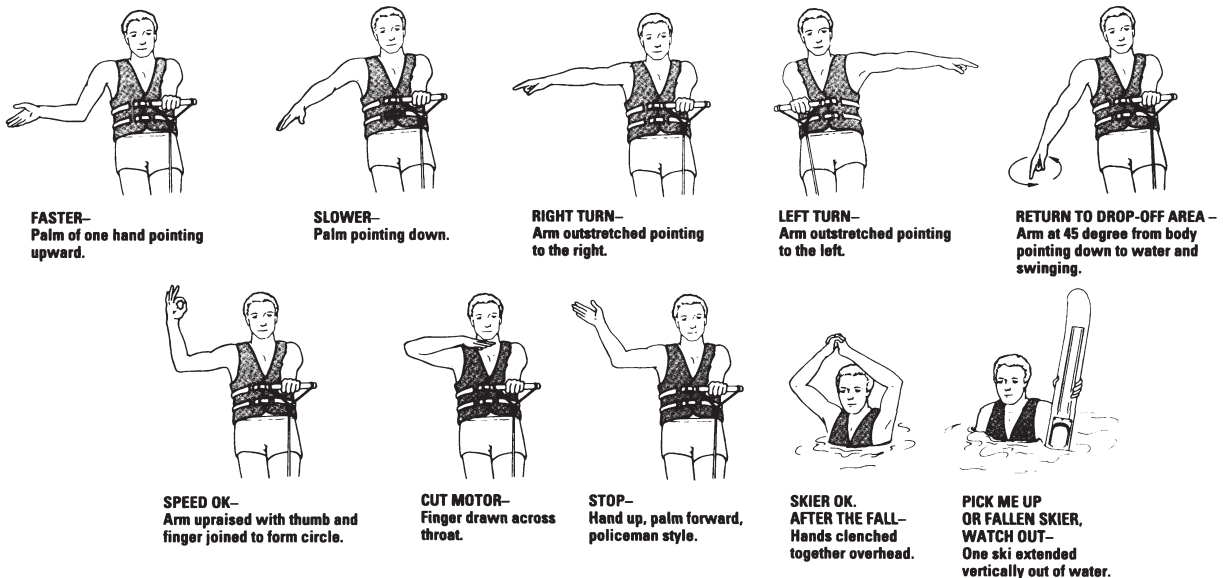

Figure B17: Skier's Hand Signals

C - 1 GENERAL

Basic rules of seamanship, general information about navigational aids, and sources for additional reading and boater education are presented in this portion of your owner's manual.

A. Boating Regulations

The US Coast Guard is the authority of the waterways. State boating regulations are enforced by local authorities. Your boat is subject to the marine traffic laws known as "Rules of the Road," which are enforced by the US Coast Guard. You are subject to marine traffic laws and "Rules of the Road" for both federal and state waterways; you must stop if signaled to do so by enforcement officers, and permit them to board if asked. The "Navigational Rules, International-Inland Rules of the Road" can be obtained from the US Coast Guard website at www.uscgboating.org.

Many pamphlets prepared by the US Coast Guard are available. They explain signal lights, buoys, safety, international and inland regulations and other information which goes beyond the scope of this manual. "Aids to Navigation" (US Coast Guard pamphlet #123) explains the significance of various lights and buoys. Because of proposed alterations to buoys and markers, contact the US Coast Guard or visit their website to stay informed of changes. Other pamphlets, including the "Boating Safety Training Manual" and "Federal Requirements For Recreational Boats," are also available from the US Coast Guard.

NOTICE

The spoken word "MAYDAY" is the international signal for distress. "MAYDAY" should NEVER be used unless there is grave or imminent danger, and you are in need of immediate assistance.

B. Rules of Seamanship

1. Right-of-way

In general, boats with less maneuverability have right-of-way over a more agile craft. You must stay out of the way of the following vessels:

A vessel not under command or aground.	These vessels have no maneuverability.
A vessel restricted in its maneuverability.	These vessel are performing work which limits their maneuverability such as surveying, dredging, laying pipe or cable, servicing navigational markers among others.
A vessel engaged in fishing.	These include boats fishing with lines, trawl or nets; but not trolling lines.
Sailboats	Sailboats have the right-of-way over power boats; however, if a sailboat is using a propeller to move forward, it is considered a power boat even if its sails are up.

2. Meeting Head-On

When two boats meet head-on neither boat has right-of-way. Both boats should decrease speed and pass; port to port. However, if both boats are on the left side of a channel, each vessel should sound two short horn blasts and pass to starboard to starboard. See Figure C1.

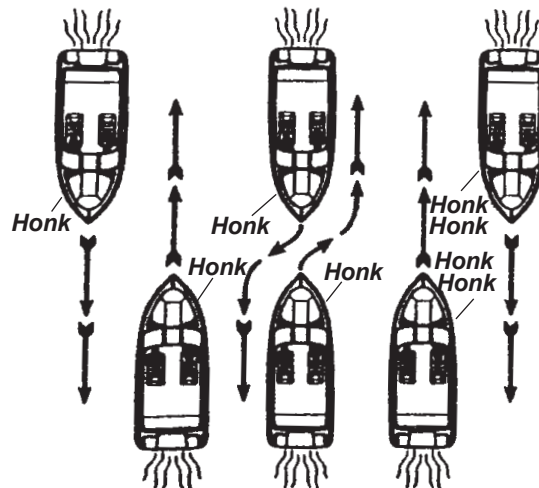

Figure C1: Meeting Head-On

3. Crossing Situations

In a crossing situation, the boat on the right from the 12-4 o'clock position has the right-of-way. It must hold course and speed. The boat without the right-of-way must keep clear and pass to the stern. See Figure C2.

Stand-on (Privileged) Vessel holds course and speed.

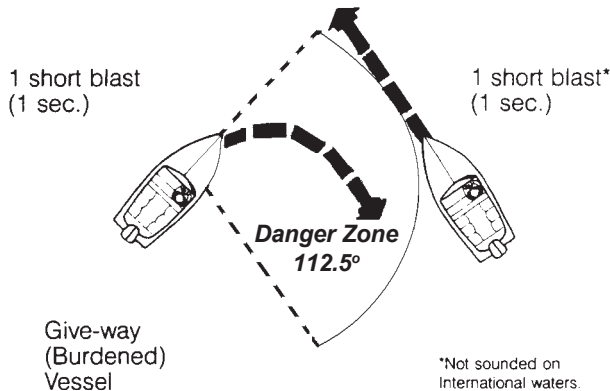

Figure C2: Crossing Situation

4. Overtaking

The boat overtaking the one ahead must yield the right-of-way to the boat being passed. The overtaking boat must make necessary adjustments to keep out of its path. The boat being passed should hold its course and speed. See Figure C-3.

Inland Rules	Stand-on (Privileged) Vessel Being Overtaken	Inland Rules
"I want to pass you on your port side."		"I want to pass you on your starboard side."
2 short blasts (1 sec.)		1 short blast (1 sec.)
"Proceed"		"Proceed"
2 short blasts (1 sec.)		1 short blast (1 sec.)
International Rules		International Rules
"I am altering my course to port."		"I am altering my course to starboard."
2 short blasts (1 sec.)		1 short blast (1 sec.)
International Rules in Narrow Channels		International Rules in Narrow Channels
"I intend to pass you on your port side."		"I intend to pass you on your starboard side."
2 prolonged blasts (4-6 sec.)		2 prolonged blasts (4-6 sec.)
2 short blasts (1 sec.)		1 short blast (1 sec.)
"Proceed."		"Proceed."
1 prolonged, 1 short		1 prolonged, 1 short
1 prolonged, 1 short		1 prolonged, 1 short blast

Figure C3: Overtaking

5. The General Prudential Rule

The general prudential rule regarding right-of-way is that if a collision appears unavoidable, neither boat has right-of-way. As prescribed in the "Rules of the Road", both boats must act to avoid collision.

6. Night Running

Boats operating between sunset and sunrise (hours vary by state), or in conditions of reduced visibility, must use navigational lights. Nighttime operation, especially during bad weather or fog, can be dangerous. All "Rules of the Road" apply at night, but it is best to slow down and stay clear of all boats regardless of who has right-of-way.

To see more easily at night, avoid bright lights when possible. Also, it is helpful to have a passenger keep watch for other boats, water hazards, and navigational aids.

To determine the size, speed and direction of other vessels at night, you should use running lights. A green light indicates the starboard side, and the red light indicates the port side. Generally, if you see a green light, you have the right-of-way; if you see a red light, give way to the other vessel. See Figure C4.

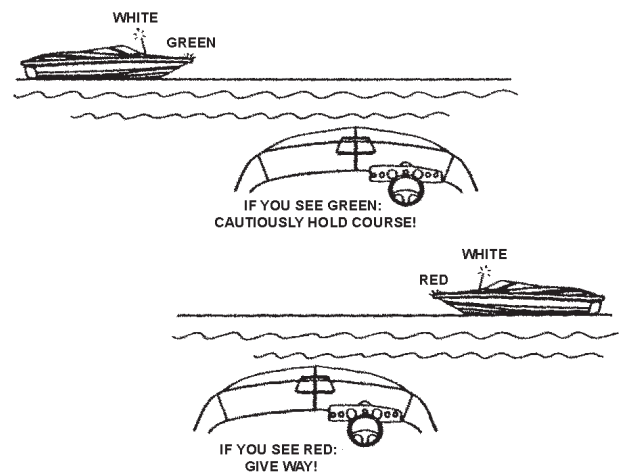

Figure C4: Night Running

7. Whistle Signal

Out on the water, whistle signals are commonly used. Although using a whistle signal is not necessary every time a boat is nearby, operators must signal their intentions when necessary to avoid potentially confusing or hazardous situations. Use whistle blasts early enough to be noticed and understood by other boaters.

It is customary for the privileged boat to signal first and the yielding boat to return the same signal to acknowledge she understands and will comply. Use the danger signal (five or more short and rapid

blasts) if intent is not clear. A short blast is one or two seconds long. A long blast is 4 to 6 seconds long. The Navigational Aids Chart at the end of this manual lists the meanings of the various whistle signals.

C - 2 NAVIGATIONAL AIDS

Aids to navigation (ATONS) help you to travel safely on the water. They help you get from one place to another and are most helpful if you have a nautical chart. A navigational aids chart is at the end of this manual (inside back cover).



DANGER

NEVER tie your vessel to an ATON. It is illegal because it blocks the ATON from view of other boaters. Decreased visibility can contribute to a serious accident which may result in property damage, personal injury, or death.

There are two ATON systems. The system used on federal waters is known as the International Association of Lighthouse Authorities System B (IALA-B). The US Coast Guard maintains this system. The second system is the Uniform State Waterway Marking System (USWMS). This system is maintained by state authorities.

A. International Association of Lighthouse Authorities System B (IALA-B)

IALA-B uses four types of ATONS. This section discusses the two most common markers: lateral markers and safe water markers. Other federal markers include special markers and isolated danger markers. The Navigational Aids Chart at the end of this manual shows these aids.

B. Lateral Markers

Lateral markers indicate the sides of navigable channels. They consist of lighted can or nun buoys and daymarks. Each has a number and is either red or green. The numbers on the green markers are odd. Red markers have even numbers.

Buoys are red or green floating ATONS. If lighted, they have either red or green lights. Unlighted green buoys, called cans, look like cylinders. Unlighted red nun buoys have a cone shaped top with their points cut off. Do not pass too close to a buoy. You may foul the propeller in its chain.

NOTICE

Buoys are anchored floating objects and may not always be in exactly the same position.

Daymarks are red or green boards with numbers. They are on posts or groups of pilings tied together and called dolphins. Daymarks and their supports are daybeacons. Daybeacons may or may not have lights. If a red or green daybeacon has a light, it is the same color as the marker-red or green. Red daymarks are triangular and have even numbers. Green daymarks are square and have odd numbers.

Red Right Returning is a basic rule to assist you in using lateral markers. When you are returning from seaward, keep red markers on the starboard (right) side when you pass them. Keep green markers to the port side.

Returning from seaward is very clear if you have been on the ocean. You are returning to port. By agreement, going upstream on a navigational river is returning from seaward. The outlet ends of the Great Lakes are also the seaward ends. Traveling from a large body of water to a smaller one is considered returning from seaward.

C. Safe Water Markers

Safe water markers have vertical red and white stripes and mark the center of navigable channels and fairways. Safe water markers included both lighted and unlighted buoys and daymarks. If a marker is lighted, the light is white and flashes the letter "A" in Morse Code.

Preferred Channel markers have horizontal red and green bands. If lighted, the color of the light is the same as the top of the band. They show the preferred channel for you to use at a junction point. Be sure to notice the color of the top of the band, and treat it as any other marker you would of that color. If the band is red and you are returning from seaward, keep the marker to the right.

Most lights on markers flash on and off. Others such as lights on aids with no lateral significance are fixed. They stay on all night. ATON lights flash in regular patterns. For example, they may flash every three seconds, or in groups such as two flashes and a pause. There are a number of flashing patterns, which help you identify the light at night. To identify

a light, note its color and pattern or timing of flashes, and compare it to your chart to find its location.

D. The Uniform State Waterway Marking System

This section discusses three kinds of markers in this system: Regulatory, Informational, and Lateral.

Regulatory markers in this system are either signs or buoys. Signs are square with orange borders. Regulatory buoys are white and shaped like cylinders. They have horizontal orange bands near their tops and just above the water's surface. An orange circle on a marker means a controlled area. A message such as "No Wake, Idle Speed, No Skiing, or 5 M.P.H." may appear on a marker. An orange diamond means danger. If a diamond has an orange cross inside it, do not enter the area. The reason you should stay out, such as "Swim Area" may be printed in black on the marker.

Informational Markers are white signs with orange borders. They give information such as direction, distance, and location.

Lateral markers in the USWMS system are either numbered red or black buoys. Black buoys may have green reflectors or lights. They are the equivalent of green buoys in the IALA-B system. Red buoys may have red reflectors or lights. They are the same as red buoys in the IALA-B system. Red or black buoys are usually found in pairs – pass between them.

E. A Special Sign

In Florida, you may see a special sign: "Caution, Manatee Area". When you see this sign, slow down to idle speed. Manatees, an endangered species, are passive, large, slow-moving mammals. Many manatees are seriously injured or killed each year by boat propellers.

F. Noise

Always be aware of local laws on noise limits. Noise means engine noise, radio noise or even yelling by people on your boat. Good seamanship demands that you operate your boat quietly so as not to infringe on the rights of others. Do not use thru-hull exhaust unless you are well offshore.

C - 3 ANCHORING

The weight of the anchor and diameter of anchor line should be governed by the size and weight of your boat. Keep anchor secure while underway to prevent damage or injury due to sudden shifting in the boat's attitude.

Use two or more anchors if anchoring overnight or for extended periods. If not using two anchors, make certain there is sufficient clearance for your boat to swing in a full circle to prevent damage in case of shifting winds.

Make certain you have enough anchor line (or scope) for the depth of water. Your anchor line should be 6 to 7 times the depth of water anchored in. For example, if you are in 20 feet of water, use 120 to 140 feet of anchor line.

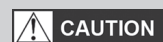

*Secure anchor line to bow eye or deck cleat.
Never tie anchor line to a rail, rail fitting or other hardware not designed to support this stress.*

To drop anchor (if equipped):

Approach your selected anchoring site from downwind and come to a dead stop over the spot where you want to drop anchor. Lower the anchor manually or by using the windlass if applicable.

Maneuver the boat slowly backwards until length of anchor line is 6 or 7 times the depth of the water.

Fasten the anchor line around the bow eye or deck cleat. Anchor flukes should dig in and catch. Watch for anchor drag by checking shoreline landmarks at the time the anchor is dropped and one-half hour later. If the boat has drifted away from these reference marks, the anchor is dragging and must be reset.

To weigh anchor:

Start the engine running before pulling in anchor.

Slowly maneuver the boat forward to reduce tension on the line and make retrieval of the anchor line easier.

Raise the anchor manually or by using the windlass if applicable. Make sure the anchor safety strap is attached to anchor chain nearest the anchor or anchor shackle or anchor eye depending upon how the anchor is rigged. Properly stow anchor and anchor line.



Always be sure to raise and secure the anchor prior to operating your boat. Failure to raise and secure anchor before getting underway could result in severe injury or damage to boat from rebounding anchor.



Always utilize the anchor safety strap provided with the windlass/bow roller combination. The chain stop prevents the anchor from accidentally releasing while the boat is moving thus preventing damage to the boat or possible injury or death to individual(s) aboard the boat.

If the anchor becomes stuck, attach the vertical line to the mooring cleat. Wave action on the bow may lift flukes from the bottom and free the anchor. If the anchor is still stuck, feed out a few feet of line and attach it to the bow cleat. Maneuver the boat around the anchor, keeping the line firm. Determine the angle that will work to pull the anchor free.

Anchors are available in different shapes, sizes and weights to fit different boats, uses, and conditions. Your Four Winns dealer can tell you which anchor will work best for your boat.

C - 4 RECOMMENDED READING

We recommend that you read the boating literature published by your state boating agency and the US Coast Guard. Other suggested reading includes the following:

Damford, Don. Anchoring. (ISBN 0-915160-64-1). Seven Seas.

United States Coast Guard Auxiliary. Boating Skills and Seamanship. LC74-164688. (illus.). (ISBN 0-930028-00-7). US Coast Guard.

Bottomley, Tom. Boatman's Handbook, (illus.). 316 p. (ISBN 0-688-03925-1, Hearst Marine Book). Morrow.

Whiting, John and Bottomley, Tom. Chapman's Log and Owner's Manual. 192 p. (ISBN 0-686-96737-2). Hearst Marine Book.

Chapman, Charles F. and Maloney, E.S. Chapman's Piloting, Seamanship and Small Boat Handling. (illus.). 62 p. (ISBN 0-87851-814-2, Pub. by Hearst Bks.); deluxe ed. (ISBN 0-87851-815-0). Morrow.

National Fire Protection Association. Fire Protection Standard for Pleasure and Commercial Motor Craft. (ISBN 0-317-07388-5, NFPA 302). National Fire Protection Association.

Brotherton, Miner. Twelve-Volt Bible. (ISBN 0-915160-81-1). Seven Seas.

C - 5 CONTACTS

There are many good boating publications that have information about your area and what other boats are doing, such as clubs and other activities. Educational programs are sponsored by publications and organizations such as the US Power Squadron, US Coast Guard Auxiliary and the American Red Cross. See your dealer about special courses available in the area. For detailed information contact:

American Red Cross
Local address (see local telephone directory)
website: www.redcross.org

Boat U.S. Foundation for Boating Safety
1 800-336-BOAT
website: www.boatus.com/courseline

US Coast Guard Office of Boating Safety
website: www.uscgboating.org

Skippers Course
GPO Superintendent of Documents
Washington, DC 20012
202 512-1800
202 512-2250 (fax)

United States Coast Guard Auxiliary
Local Flotilla or contact appropriate Coast Guard District Headquarters
website: www.cgaux.org

United States Coast Guard Headquarters
2100 2nd St., SW
Washington, D.C. 20593-0001
202 267-1060
website: www.uscgboating.org

United States Power Squadron
P.O. Box 30423
Raleigh, NC 27617
website: www.usps.org

C - 6 OWNER'S LOGS AND RECORDS

At the end of this owner's manual are several forms which you will find very helpful.

The **Float Plan** provides a record of your destination, departure and return times, boat description, passenger list, and other information about the trip you have planned. At the bottom of the form is space for listing emergency telephone numbers in case your return is delayed past the expected time. It also has space for indicating information about the person filing this report. Leave the completed form ashore with a responsible person. We recommend you make several copies of this form each boating season to assure an ample supply.

The **Fuel Log** is a handy way to record information covering engine hours, fuel consumption, miles traveled, as well as RPM (revolutions per minute), average MPH (miles per hour) and GPH (gallons per hour).

The **Service/Maintenance Log** provides a record of maintenance work completed, the date of completion, and the engine hour reading. This log also helps you identify the frequency of routine maintenance work, such as engine oil changes. If you should decide to sell your boat, it demonstrates to prospective buyers that you have done a good job taking care of it.

The **Service Information Sheet** allows you to record all the pertinent information regarding your Four Winns® boat. This sheet will be extremely helpful when ordering additional/optional parts for your boat or when having service work done.

C - 7 NAVIGATIONAL AIDS CHART

The illustrated Navigational Aids Charts contain information concerning whistle signals, storm warnings, bridge signals, and buoy descriptions. See the inside back cover of this manual.



D - 1 FOUR WINNS WARRANTY POLICY

The Four Winns Winning Edge™ Owner Protection Plan provides the new Four Winns purchaser with one of the most comprehensive corporate commitments in the marine industry today. The Winning Edge™ Owner Protection Plan defines the warranty coverage on all units manufactured by Four Winns. It thoroughly describes the warranty policies and those procedures to be followed to obtain warranty coverage. Review the Four Winns Owner Protection Plan and limited warranty statements carefully.

All engines utilized in the Four Winns® product are warranted by the engine manufacturer. Your Four Winns dealer is authorized to repair your engines and will work closely with the engine manufacturer to resolve any problems you have.

D - 2 DECK/HULL STRUCTURE WARRANTY

Each unit manufactured by Four Winns is encompassed by a separate warranty providing specific coverage on the deck/hull structure. The Winning Edge™ Owner Protection Plan thoroughly describes this coverage.

D - 3 WARRANTY REGISTRATION

A Four Winns Warranty Registration is attached to the Winning Edge™ Owner Protection Plan statement. Your Four Winns Dealer is responsible for completing and submitting the warranty registration at the time of purchase. The receipt of the warranty registration is the sole basis for establishing proof of ownership of the boat and corresponding warranty validation.

By signing the warranty registration you, the new owner, indicate an understanding of the terms and conditions of the Limited Warranty. The warranty registration should be properly completed by the dealer, signed by the new owner, and submitted to us via the Extranet within fifteen (15) days after the original purchase in order to validate the warranty. This is a dealership's responsibility. Be sure to keep a copy of the Owner's Registration for your records. All warranty registrations are performed on-line via the Extranet.

All boat manufacturers are required by The Federal Boat Safety Act of 1971 to notify first time owners in the event any defect is discovered "which creates a substantial risk of personal injury to the public." In order for us to notify you if necessary, be sure to verify the accuracy of the Winning Edge™ warranty registra-

tion upon receipt. You should receive your Winning Edge™ warranty registration at the time of delivery or within approximately 30 days from the day of your boat purchase. If you have not received your Winning Edge™ warranty registration within this time frame please contact your Four Winns selling dealer for resolution. If upon receipt of the warranty registration you discover a discrepancy, please notify Four Winns at 231 775-1343. The information will be corrected and a new copy will be supplied to you.

Other equipment manufacturers also require that their products be registered with their respective company. Warranty registrations are provided in the owner's information packet.

D - 4 TRANSFER OF WARRANTY

Four Winns' confidence in the product and our warranty commitments can extend after the original purchaser may choose to move on to a new boat. The remainder of the Four Winns warranty coverage is transferable to the second owner of the boat for a fee. The warranty may be transferred only once. Registration of the second owner is required and the amount of the transfer fee is indicated on the warranty statement of the Warranty Registration . Transfer of the remainder of the warranty must occur within five (5) years of the original retail sale. The transfer fee must be paid within fifteen (15) days of purchase of the used boat by check, money order or cashier's check payable to Rec Boat Holdings, L.L.C. Proof of purchase date is required. The Winning Edge™ Owner Protection Plan thoroughly describes the action required to transfer warranty coverage.

D - 5 PRE-OWNED UNIT REGISTRATION

Section E-4 Transfer of Warranty discusses the need to properly register the purchase of a pre-owned boat with Four Winns in order to transfer applicable warranty coverage.

Purchasers of all Pre-Owned Four Winns models, regardless of the decision to transfer warranty coverage, are encouraged to register ownership with Four Winns. To register ownership of a "Pre-Owned Four Winns® boat," provide Four Winns with your name, address, daytime phone number, e-mail address, purchase date, and hull serial number of the boat purchased. The hull serial number plate is permanently affixed to the starboard side of the transom. Registration of a Pre-Owned Four Winns® boat does not extend or in any way affect or modify the specific

terms of the Winning Edge™ Owner Protection Plan or Limited Warranties. We provide this service to the purchasers of Pre-Owned Four Winns® boats in the interest of better boating. Four Winns welcomes every purchaser of a Four Winns® boat, new or used, to our family.

D - 6 INSURANCE COVERAGE

One of your responsibilities as a new boat owner is to acquire proper insurance protection. Insurance should include comprehensive and general liability coverage appropriate to your financial needs. Please contact your local agent for assistance on insurance coverage.

D - 7 SERIAL NUMBER RECORD

The manufacturer, model, and serial number of major components are recorded during the assembly of each Four Winns® boat. A copy of this form is included in the owner's packet. Using this form, you may want to have your dealer help you complete the service information form at the back of this manual. A copy of the serial number record should be made and kept by the dealer in his records. This can assist the dealer in processing warranty claims, or obtaining necessary information. The original copy of the serial number record should be kept in the owner packet. The service information form should remain in the owners manual for easy reference.

D - 8 PRE-DELIVERY SERVICE

Four Winns makes every effort to deliver your boat in "turn key" condition to the dealer. The process of transporting and handling the boat necessitates certain inspections and adjustments prior to delivery to you. Also, various aspects of operation must be checked and adjusted immediately prior to final delivery and use.

The selling Four Winns dealer must perform this thorough review of the boat and its numerous systems during the commissioning or "dealer pre-delivery service" of the craft.

A Four Winns Pre-Delivery Inspection Form is part of the Warranty Registration. It lists the many items encompassed by the pre-delivery service previously described. The dealer is to check off the items as they are completed, and complete the form as indicated providing specific performance related information appropriately.

Your Four Winns dealer will sign the Pre-Delivery Inspection Form of the Warranty Registration upon completion of the work. You will also be asked to sign the Pre-Delivery Inspection Form upon accepting delivery of the boat. You are to retain the two copies marked "Boat Owner". Your dealer is to retain the copy marked "Dealer copy" for his records. The manufacturer's copy is submitted on-line via the Extranet to the Four Winns Customer Service Department.

D - 9 REPLACEMENT PARTS

Four Winns dealers have access to an electronic Four Winns parts manual that details the components of each model and their appropriate part numbers. Many Four Winns dealers inventory common replacement components.

In addition, Four Winns maintains specific records on the components used in the manufacture of each unit and makes a concerted effort to maintain components specifically to fill replacement part needs.

The Four Winns dealer from whom you purchased your boat is in the best position to meet your needs. If the dealer does not have the needed item, the dealer has the capability, through direct contact with the Four Winns Customer Service Department, to obtain it quickly. Four Winns will only sell replacement parts to established Four Winns dealers. If you relocate and cannot find a Four Winns dealer close to you, contact the Four Winns Customer Service Department for information on the nearest dealer in your area.

D - 10 OWNER'S RESPONSIBILITIES

1. Sign the warranty registration verifying your address, model and hull serial number. The dealer is responsible for on-line submission of the warranty registration.
2. Inspect the boat at the time of delivery to verify that all systems and components are operating safely and acceptably. Read all manuals and instructions.
3. Operate all equipment in compliance with the manufacturer's instructions.
4. Review the pre-delivery checklist for the boat and engine with your dealer when you take delivery.

5. Schedule your 20-hour boat and engine checkup with your dealer.
6. Know how to safely operate your boat and the rules of the road before you use your boat.

IMPORTANT: Make sure that your dealer checks the engine alignment during your boat's 20-hour checkup. The engine alignment check should be performed in accordance with recommended procedures as stated by the engine manufacturer in your engine owner's manual. Failure to do so could result in drive train damage, which is not covered under the warranty.

7. We recommend that you review your engine owner's manual and warranty certificate for break-in advice, initial inspection and service requirements.
8. Perform or provide for the scheduled maintenance checks outlined in this manual and all related service guides and manuals.
9. You are responsible for any modifications made to the boat or its equipment that could affect the safe operation of the boat.

Along with boating, comes responsibility...responsibility for safety, boating laws, and the environment. Please think about the future of our waterways, oceans and marine life while you're out enjoying them and take all necessary measures to help protect what natural habitats we have left. Keeping our waterways and marine habitats free from debris, and showing consideration for the creatures who thrive in these environments are some ways you can help assure the pleasure of boating for years to come.

The operator is also responsible for complying with the following procedures and operational requirements:

- State registration
- Insurance
- Warranty registration
- Warranty terms and conditions
- Rules of the road
- Break-in procedure
- Proper maintenance of the boat and its systems
- Safety equipment
- Safety training of passengers and crews
- Knowledge of boat systems
- Seaworthiness/operational inspection
- Safe operating practices
- Avoiding use of drugs/alcohol

- Environmental regulations
- Accident reporting

D - 11 CONSTRUCTION STANDARDS

All Four Winns® boats meet or exceed the construction standards set by the US Coast Guard and the American Boat and Yacht Council (ABYC) concerning:

- Navigational lights
- Factory-installed fuel systems
- Engine and fuel tank compartment ventilation
- Flotation
- Steering systems
- Backfire flame arresters

We recommend that you see your dealer if you wish to modify factory-installed equipment or add new equipment. Your dealer is qualified to make such modifications or additions without placing the safety or design integrity of your boat at risk and without invalidating the warranty.

D - 12 WINNGEAR

Show your colors! Four Winns offers a complete line of sports clothing designed to complement your new boat. The WinnGear™ line is on display on our website at www.fourwinns.com.





NAME / ADDRESS CHANGE FORM

Name & Address:

Please print clearly.

Telephone & E-mail Address:

Hull Identification Number:

Boat Model:

Date of Purchase:

NOTE: For warranty transfer please use the Warranty Transfer Request Form also included in this manual.



NAME / ADDRESS CHANGE FORM

Name & Address:

Please print clearly.

Telephone & E-mail Address:

Hull Identification Number:

Boat Model:

Date of Purchase:

NOTE: For warranty transfer please use the Warranty Transfer Request Form also included in this manual.



NAME / ADDRESS CHANGE FORM

Name & Address:

Please print clearly.

Telephone & E-mail Address:

Hull Identification Number:

Boat Model:

Date of Purchase:

NOTE: For warranty transfer please use the Warranty Transfer Request Form also included in this manual.

Please place in envelope and mail to:
Rec Boat Holdings, L.L.C.
Attn: Four Winns Customer Service
925 Frisbie Street
Cadillac, MI 49601

Please place in envelope and mail to:
Rec Boat Holdings, L.L.C.
Attn: Four Winns Customer Service
925 Frisbie Street
Cadillac, MI 49601





Rec Boat Holdings, L.L.C., 925 Frisbie Street, Cadillac, MI 49601 Phone (231) 775-1343

WARRANTY REGISTRATION TRANSFER REQUEST

Original Owner Name & Address:

Original Date of Purchase:

Hull Identification Number:

Boat Model:

Selling Dealer:

Name and address of new purchaser:

Telephone & E-Mail Address:

Date of Purchase:

The warranty may be transferred only once. Registration of the second owner is required and the amount of the transfer fee* is indicated on the warranty statement of the Warranty Registration Card. Transfer of the remainder of the warranty must occur within five (5) years of the original retail sale. The transfer fee must be paid within fifteen (15) days of purchase of the used boat by check, money order or cashier's check payable to Rec Boat Holdings, L.L.C.

This warranty registration request if accepted, transfers the warranty coverage remaining on the boat to the new purchaser. Acceptance of this request does not create any additional warranties or obligation on Rec Boat Holdings, L.L.C.

Warranty Expiration Date:

Four Winns Transfer Acceptance Date:

Four Winns Authorized Signature:

Mail to: Rec Boat Holdings, L.L.C.

Attn: Four Winns Customer Service Department
925 Frisbie Street,
Cadillac, MI 49601

***Subject to change without notice.**



E - 1 GENERAL

DO NOT attempt to service any engine without being totally familiar with the safe and proper service procedures. Do not attempt to maintain or adjust an engine while it is running. Certain moving parts are exposed and failing to shut off the engine can result in serious injury or death.

Four Winns does not manufacture engines. Because of the technical nature of the engines, all manufacturers of these items require that warranty and service problems be taken directly to an authorized dealer for resolution. The Four Winns dealer from whom you purchased your boat will handle all warranty and service matters with the engine manufacturer for you.

In compliance with the Federal Boat Safety Act of 1971, all engine manufacturers require their products to be registered. A registration card is furnished with each new engine. When selling a Four Winns® boat, the dealer, along with the purchaser, should complete the information requested on these cards and return them to the respective engine manufacturers. Engine registration cards are provided with the engine and will usually be found with the owner's information packet.

Each manufacturer of the various marine power components provides an owners information manual with their product. This publication is included with this manual. It is important that you read the manual(s) carefully and become completely familiar with proper care and operation of the engine system. Be sure to read the section on winterization. Replacement costs associated with frozen engine components are quite substantial.

Also review the other sections in this manual, especially Sections I on Fuel Systems, and Section F on Control Systems.

E - 2 ENGINE EXHAUST

The carbon monoxide in exhaust fumes can be hazardous. It is important for you and your passengers to be aware of the potential safety hazard created by exhaust fumes. Familiarize yourself with the symptoms of individuals overcome by carbon monoxide, and most importantly, ways you can protect yourself and your guests.



DO NOT inhale exhaust fumes! Exhaust contains carbon monoxide which is colorless and odorless. Carbon monoxide is a dangerous gas that is potentially lethal.

Persons overcome by carbon monoxide may exhibit the following symptoms:

- a. *Watering and itchy eyes*
- b. *Flushed appearance*
- c. *Throbbing temples*
- d. *Inattentiveness*
- e. *Inability to think coherently*
- f. *Ringing in the ears*
- g. *Tightness across the chest*
- h. *Headache*
- i. *Drowsiness*
- j. *Incoherence*
- k. *Nausea*
- l. *Dizziness*
- m. *Fatigue*
- n. *Vomiting*
- o. *Collapse*
- p. *Convulsions*

IF YOU THINK EXHAUST FUMES ARE ENTERING YOUR BOAT, DETERMINE THE CAUSE AND HAVE IT CORRECTED IMMEDIATELY!

The following suggestions can help prevent exhaust fumes from entering the boat:

1. DO NOT allow the boat to remain stationary with the engine running for an extended period of time. Do not stand or swim near the exhaust output or outdrive when the engine is idling.
2. Use extreme caution while operating the engine in confined areas such as enclosed slips or congested piers. Operation under such conditions could easily lead to exhaust gasses (carbon monoxide) entering even though you may have all the hatches, windows, doors and portholes closed.
3. Persons sleeping can be easily overcome by carbon monoxide because they are unaware of its presence. Sleeping while the engine is running is not recommended. If persons are sleeping aboard while underway, those awake should monitor for carbon monoxide accumulation in the cabin; especially the sleeping areas.

⚠ WARNING

NEVER operate the propulsion engine while everyone onboard is sleeping. Fatal carbon monoxide poisoning can occur.

For additional information, refer to Section B-2 Carbon Monoxide.

E - 3 ENGINES

Consult the Engine Owners Manual included in the owner's packet for additional operation and maintenance information.

E - 4 PROPELLERS

Knowledge of the propeller is most easily gained through better understanding of the terminology used to refer to the aspects of propeller size and performance.

NOTICE

Never run with a damaged propeller. You can damage the engine or drive unit. Keep a spare propeller and the necessary tools to replace a propeller onboard.

A. Diameter

Diameter is twice the distance from the center of the prop shaft to the extreme tip of a propeller blade. Increasing or decreasing propeller size will have a direct bearing on the RPMs (revolutions per minute) an engine will develop. This is due to the greater amount of propeller blade surface in contact with the water. See Figure E1.

B. Pitch

Pitch is a measure of helix angle, or angle of attack, of the rotating blade. Pitch is easily understood if one imagines the propeller rotating through a semisolid such as butter or jello. The distance the propeller will travel in one revolution is called "Pitch." Increasing or decreasing pitch will also have a direct bearing on engine RPMs because of the greater bite taken by the blade with each rotation. See Figure E1.

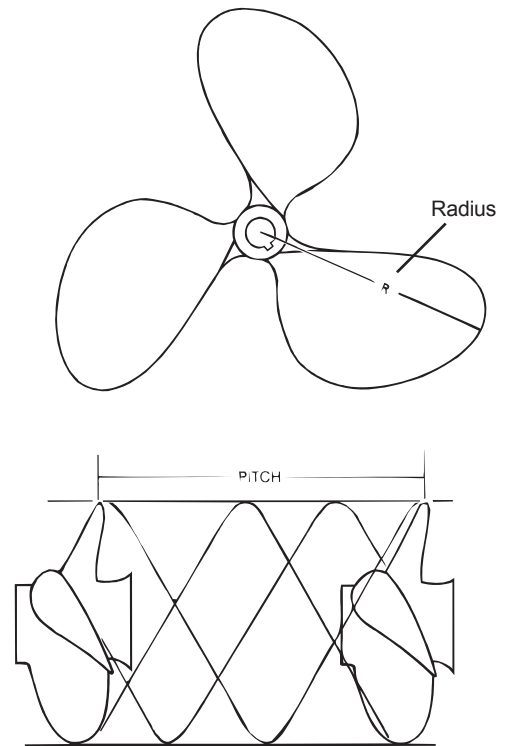

Figure E1: Propeller Pitch & Diameter

C. Prop Slip

When traveling through water, a propeller is unable to get a complete bite because of the fluidity of water. "Prop slip" is usually expressed as a percent of the computed theoretical speed. Fifteen to twenty-five percent prop slip is common for a sport-type boat operating at cruising speed.

Changing either diameter (Rx2) or pitch will have an effect on engine speed and prop slip, and in turn, directly affect the performance of a boat. The propeller(s) included with each Four Winns® boat provide the best general performance based on data obtained from on-the-water testing of that model. Variations in load, operating conditions, environment, the individual engine and hull performance may necessitate the purchase and use of another propeller(s).

Under your normal load conditions the engine(s) should turn within the maximum RPM range when at full throttle. If the engine(s) exceeds the recommended RPM, an increase in pitch and/or diameter is required. If the engine RPM is too low, a decrease in pitch and/or diameter is required.

An engine that is not developing full power and the load carried in a boat will directly affect performance of the engine. Always be sure the engine is properly tuned and load conditions are those normally experienced, before changing propellers.

For additional information on factors affecting performance, please consult your Four Winns dealer.

E - 5 RUNNING ANGLE & POWER TRIM/TILT

Hull planing surfaces have the least amount of drag at a three to five degree angle with the water. This is the preferred running angle when boating. The running angle has a significant impact on top speed and handling. See Figure E2. Heavy load or certain water conditions may make it difficult to achieve the optimum running angle. The running angle can be controlled through the use of the power trim.

A. Power Trim

Trim angle is how far in or out, the drive is positioned in relation to the bottom of the boat. The trim angle of the drive has a distinct affect on the running angle of the boat.

The power trim system permits control of the trim angle of the drive relative to the boat, at the touch of a button. It allows the drive to be raised for shallow water operation. Power trim also allows the operator to adjust the drive while underway to provide the ideal running angle for a given load and water condition. Additional information can be found in the engine operator's manual included in the owner's packet.

B. Power Tilt

Power tilt allows the operator to raise and lower the drive for trailering, launching, and beaching. Additional information on power tilt can be found in the engine operator's manual included in the owner's packet.

NOTICE

DO NOT operate the motor with the water intakes out of the water. Severe damage to the engine systems can result. Consult the engine operator's manual for specific information.

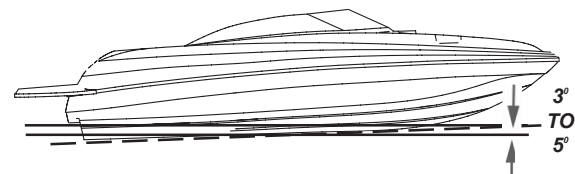

Boat Properly Trimmed

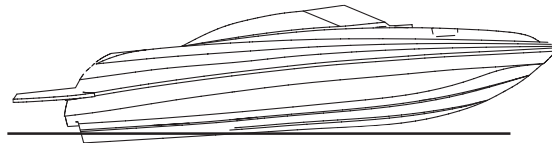

Boat Too High - Trim Bow "Down"

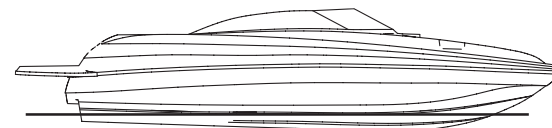

Boat Too Low - Trim Bow "Up"

Figure E2: Running Angle

E - 6 TRIM TABS (Applicable Models Only)

Electric/hydraulic trim tabs are available on certain models. Check with your dealer for availability on your model. Trim tabs help provide maximum control of the hull in all water and load conditions. Used properly, trim tabs can:

- Compensate for wind and load listing (level the boat side to side).
- Induce faster planing and help achieve optimum running angle (see Section E-5 - Running Angle & Power Trim/Tilt).

The proper use of electric/hydraulic trim tabs requires a basic understanding of trim tab operation and some practice in calm water. Be sure to read the manufacturer's literature included in the owner's packet.

The trim tab control uses two (2) momentary-type rocker switches. The trim tab switches control the attitude or position of the boat. The trim tab switches are labeled by position such as "Bow Up" and "Bow Down". They are also labeled for "Port" and "Stbd". When pressed, the label indicates what happens to the bow of the boat.

Before leaving the dock and utilizing the trim tabs, ensure the trim tabs are in the full up position. Press both lower halves of the trim tab switches and hold (for approximately 10 seconds) until the tabs are full up.

A. Control Listing

Wind, loading and many other factors can result in the boat tilting or leaning towards one side while running. This is called listing and can be negated using trim tabs.

Pressing the lower port trim tab switch will move the starboard trim tab upward. This will result in the port bow of the boat being allowed to rise.

Pressing the lower starboard trim tab switch will cause the port trim tab to move upward and will result in the starboard bow being allowed to rise.

Pressing the upper port trim tab switch will cause the starboard trim tab to move downward and will force the port bow downward.

Pressing the upper starboard trim tab switch will cause the port trim tab to move downward and will force the starboard bow downward.

Always establish your intended heading and attain desired cruising speed before trying to adjust running attitude (using the trim tabs).

 **WARNING**

Always press the trim tab switches in short one (1) second bursts. If pressed too long, you can overcompensate, and potentially lose control. DO NOT try to correct the situation by pressing the other upper trim tab switch. Instead, raise the tab slightly by pressing the appropriate lower half of the trim tab switch.

After stabilization of speed and direction, press the upper half of the appropriate trim tab switch to achieve a level side to side running attitude. Be sure to press the correct trim tab switch to obtain the desired result.

After pressing a trim tab switch, always wait and allow time for the change in trim tab position to take effect. DO NOT continue to press the trim tab switch while awaiting trim tab reaction. By the time the effect is noted, the trim tab will move too far and thus overcompensate.

B. Induce Planing & Controlling Trim Angle

Trim tabs can also be used to facilitate faster planing and allow better control of the running angle.

Before accelerating and trying to gain plane, press both upper trim tab switches. This will cause both trim tabs to move downward and force the bow down when running. This can also be used when running the boat with a heavy load aboard.

Moving the trim tabs downward will increase the lift and the boat will achieve plane faster, or stay on plane at a lower engine and boat speed.

After gaining plane and establishing cruising speed, pressing both lower trim tab switches will cause both trim tabs to move upward and will allow the bow to rise. This should be used to adjust the running attitude of the boat to decrease the drag at cruising speed or above, or when running in a following sea.

When running at an engine speed that results in the boat falling off plane or causes the boat to plane inefficiently, lowering both tabs slightly (bow down) will improve the running angle and improve operating efficiency.

Optimum efficiency is obtained when operating at a 3 to 5 degree running angle. Utilizing too much "Bow Down" trim tab can reduce operating efficiency and cause substantial steering and handling difficulties. Be extremely careful when running in a following sea. The effect of trim tabs is amplified under such conditions. Steering and handling difficulties can result from improper trim tab usage, especially in a following sea. If unsure of proper trim tab positioning, raise the trim tabs to the full-up position.

 **WARNING**

When running at high engine speeds, be sure the trim tabs are in the full up position. Trim tab action should be only enough to compensate for any listing. Trim tab adjustments at high speeds are extremely critical. Be prepared to slow down should handling difficulties arise.

When running in a displacement (very slow speed) mode, better efficiency will be obtained with the trim tabs in the full-up position.

C. Trim Tab Maintenance (Applicable Models Only)

Check the fluid level of the trim tab reservoir often. Always keep the fluid level between the designated marks on the trim tab pump-reservoir. Refer to the manufacturers information for specifications on the type of fluid to be used and other operation and maintenance information.

E - 7 INSTRUMENTATION

The helm stations on Four Winns® models are equipped with a complete set of engine instrument gauges. See Figure E3. These instrument gauges allow the boat operator to constantly monitor the operational condition of the engine. Close observation of these instrument gauges could save the engine from damage.



Figure E3: Instrument Gauges

A. Tachometer/Hour Meter Combination Gauge

The tachometer indicates the speed of the engine in revolutions per minute (RPM). This speed is not the boat speed or necessarily the speed of the propeller. The tachometer may not register zero with the ignition key in the OFF position.

NOTICE

Never exceed the maximum recommended operating RPM of your engine. Maintaining maximum, or close to maximum RPM for extended periods can reduce the life of the engine.

Some engines are equipped with devices that limit engine RPM in accordance with the oil pressure, or engine temperature. Refer to the engine manual included in the owner's packet for additional information.

The tachometer must be set for different engines installed. This is typically done at the factory. The tachometer gauge is shown along with the table detailing the tachometer settings. See Figure E4.

TACHOMETER SETTINGS

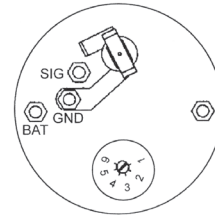

Set switch to match your engine.

CAUTION: Depress switch slightly while turning.

TACHOMETER SETTINGS	
NUMBER OF CYLINDERS	ENGINE SETTING
4*	1
6*	2
8*	3
12 POLE	4
(OB ALT)	
* 4 CYCLE ONLY	

Note: Setting information is labeled on the back of the tachometer.

Figure E4: Tachometer Settings

The tachometer/hour meter combination gauge allows for hour meter viewing at the helm. See Figure E5. The hour meter provides a numeric record of elapsed engine operating time. This information is important in determining scheduled maintenance intervals, ship's log data, cruise information, etc.

The hour meter is connected to the ignition switch. Be sure the ignition switch is in the OFF position when the engine is not operating or the hour meter will record additional time.



Figure E5: Tachometer/Hour Meter

B. Speedometer

The speedometer on the F series models are designed to be used like an automobile speedometer. See Figure E6. This automotive helm design helps give the driver a familiar feel.



Figure E6: Speedometer

NOTICE

Speedometers are not precision instruments. The indications are relative and should never be used for navigational purposes or similar critical situations.



DO NOT rely on the speedometer when trying to achieve a "NO WAKE" condition in a harbor or other enclosed waterway. ALWAYS reduce throttle! Speedometers are not effective at measuring low operational speeds. You are responsible for damage caused by the wake of your boat.

The speedometer is a water pressure sensitive unit. It has a pick-up (pitot tube) assembly mounted in the outdrive assembly and a speedo tube connecting it to the speedometer gauge on the dash. Water strikes the tube inlet and creates positive pressure. The faster the boat speed, the greater the pressure, and the higher the speed indication on the speedometer.

C. Temperature Gauge (4-in-1 Gauge)

The temperature gauge (included in the 4-in-1 gauge - Figure E7) monitors the cooling system of the engine. A sudden increase in water temperature could be a signal of a blocked cooling passage or a water pump malfunction.



Figure E7: 4-in-1 Gauge

NOTICE

Operation of an overheated engine can result in engine seizure. If an unusually high temperature reading occurs, shut the engine off immediately.

D. Oil Pressure Gauge (4-in-1 Gauge)

The oil pressure gauge (included in the 4-in-1 gauge - Figure E7) indicates the pressure in the engine lubrication system. A significant drop in oil pressure is a possible indication of an oil pump or other leakage problem.

If the engine has been equipped with an audible engine alarm, the alarm should sound if the oil pressure drops below the normal operating range of the engine. Please see your engine owner's manual for specific engine information.

NOTICE

Operation of an engine with abnormally low oil pressure can lead to engine damage and possible seizure. Have the engine serviced immediately upon a reduced oil pressure indication.

E. Voltmeter (4-in-1 Gauge)

The voltmeter (included in the 4-in-1 gauge - Figure E7) monitors battery condition and thus alternator performance. See Section H for additional information regarding electrical systems.

F. Fuel Gauge (4-in-1 Gauge)

The fuel gauge (included in the 4-in-1 gauge - Figure E7) displays the level of fuel that is present in the fuel tank. The fuel gauge will operate when the ignition switch supplying power to the fuel gauge is in the RUN position.

Due to the mechanical nature of the fuel sender, variations in readings during various speeds of operation may occur. This system is merely a relative indication of the available fuel supply and not a calibrated instrument. Refer to Section I-1E - Fuel Senders for additional information.

NOTICE

Use only clean fuel of the type and grade recommended by the engine manufacturer. The use of incorrect or contaminated fuel can cause engine malfunction and serious damage. Refer to Section I - Fuel Systems for additional information.

G. Power Trim Gauge

A trim gauge is located on the instrument panel. See Figure E8. This gauge provides a visual indication of the inward-outward (trim angle) position of the outdrive in relationship to the bottom of the boat. There is not a trailer travel mode on the gauge.

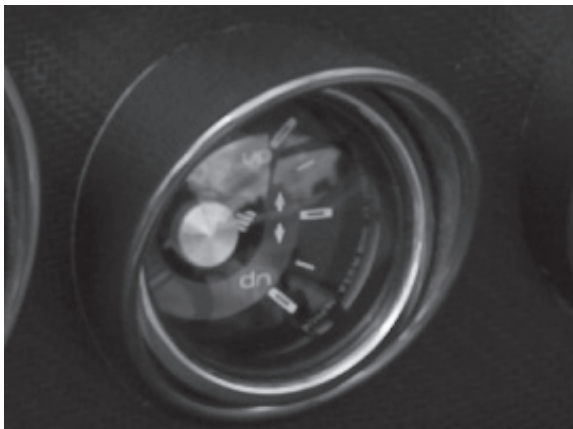

Figure E8: Trim Gauge

Additionally, a power trim switch at the transom is available on certain models. If equipped, this switch allows one to raise or lower the outdrive from the transom while standing outside the boat. See Figure E9.



Figure E9: Transom Trim Switch

H. Depth Sounder

The depth sounder with dual air and water temperature indicator is available equipment on most F series models. See Figure E10.



Figure E10: Depth Sounder

The depth sounder consists of two main components, the transducer and the depth sounder. The transducer is mounted to the hull and the depth sounder is installed in the dash. The transducer and depth sounder communicate by means of a cable, and are powered by your boat's 12-volt DC battery. The transducer and depth sounder use the basic principle of sonar to indicate the water's depth. See the following depth sounder operating instructions as well as manufacturer's literature included in your owner's packet.

General description:

1. The depth sounder will display depth of 3 feet to 199 feet. If the reading is less than 19.9 feet, 1/10th increments will be displayed. If the reading is more than 19.9 feet, all readings will be in whole numbers.
2. The depth sounder has an audible and LCD displayed depth alarm with adjustable shallow and deep limits and a depth below keel offset feature. See Figure E-6 for the display sequence. These settings once made are stored in memory and will remain even if the battery is disconnected.

Operation:

1. **Power on.** The depth sounder will activate automatically when the power to it is initially turned on. You do not have to press any key. The LCD will illuminate showing the depth in the upper display. The lower display will show a "W" and water temperature. Press the "Up" button and the lower display will change to an "A" and the air temperature will be displayed. Press the "Down" button to return to the water temperature display. To turn the depth sounder off, press and hold the "MODE" keypad for 4 seconds. Pressing the "MODE" keypad again will reactivate the unit.

NOTE: The instrument is designed to have the internal LED lighting remain on as long as power is supplied even if the unit is turned "off" at the keypad.

2. **Depth alarm - Deep mode:** Pressing the "MODE" keypad again displays the "DEEP" deep depth alarm setting. This is the deepest water that will activate the alarm. Press and hold the "Up" or the "Down" arrow keypad to adjust the reading to the desired depth.

Depth alarm - Shallow mode: Press the "MODE" keypad to display the "SHAL" shallow depth alarm setting. This is the shallowest water that will activate the alarm. Press and hold the "Up" or the "Down" arrow keypad to adjust the reading to the desired depth.

When the depth of the water is less than the shallow depth alarm setting the audible alarm will sound rapidly. When the depth of the water is deeper than the deep depth alarm setting the audible alarm will sound at 2 beeps per second.

NOTE: To fully deactivate an alarm, reset it to zero. Pressing the "MODE" keypad temporarily deactivates the alarm. To reactivate the alarm press the "MODE" keypad until the depth reading appears.

3. **Keel offset.** Pressing the "MODE" keypad again displays the "KEEL" keel offset setting. This can be set so that the depth sounder either shows the depth below the keel or the depth below the transducer. Press the up or down arrow keypads to adjust the reading to the desired depth no more than 19.9 ft. For example if the bottom of the keel is 2.5 feet below the transducer and you want the depth sounder to read the depth below the keel, the display should be adjusted to read 2.5 FT.

NOTE: Once a keel offset is programmed, the shallow and deep alarms will be activated by the depth below the keel.

Units - Change the unit of measure. The lower display will show "UNIT" and the upper display will show either "US" or "EURO" for metric units. Pressing the up or down buttons will cycle through the choices. Pressing the mode button will save the units shown in the display and change the display

Back to the normal depth mode: There will be no units shown in the displays. It will be up to the operator to determine the units from the temperature reading.

 **WARNING**

The depth sounder is not to be used for navigation or as a device to avoid grounding which may result in boat damage or personal injury. Do not rely on depth sounder to avoid submerged objects. Depth sounders provide a relative indication of water depth only. Always use caution operating in shallow areas and maintain a very slow speed. Be aware that depths may change too quickly for you to react and avoid grounding.

NOTICE

DO NOT depend solely upon the depth sounder for water depth. It is important to have navigational charts of the waters in which you are operating.

I. Four Position Ignition Switch

Most models use an ignition switch with four positions: OFF, RUN, ACCESSORIES, and START. Just like the three position switch, the START position is spring loaded and the key should be held in this position until the engine starts. The key will return to the RUN position once released. Always turn the key to the OFF position when the engine is not running. This will prevent discharging of the battery(s). The ACCESSORIES position allows the operator to run the stereo without activating the other ship's systems. Additional information on ignition switch operation is covered in Section A Operation, of this manual.

J. Emergency Stop Switch

This safety device automatically stops the engine if the lanyard is attached to the operator and the operator falls from his work station. Refer to the engine manual for detailed information about using this switch.

The emergency stop switch (Figure E11) incorporates a shutoff switch, switch clip, lanyard, and lanyard clip. The lanyard clip must be securely attached to the operator's PFD, clothing, arm, or leg. Be sure to attach the lanyard to a place where it is free of obstructions and to something that will move with the operator if he or she leaves the helm station. If the engine shuts down because this switch was activated, the clip may have to be reinstalled on the interrupter switch before the engine can be started.

 **WARNING**

Keep emergency stop switch lanyard free from obstructions that could interfere with its operation. Do not modify or remove emergency stop switch or bypass its safety features. The proper use of the emergency stop switch will prevent a runaway boat situation which can cause severe personal injury or death.

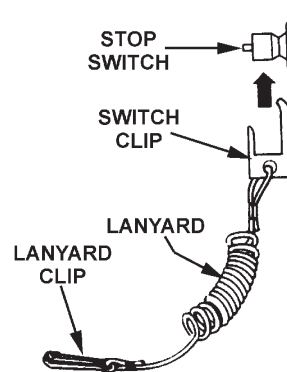

Figure E11: Emergency Stop Switch
(Note: May Vary Depending on Model & Engine Selection)

The emergency stop switch can only be effective when in good working condition. Observe the following:

1. Lanyard must always be free of entanglements that could hinder its operation.
2. Once a month, check the switch for proper operation. With engine running, pull lanyard. If the engine does not stop, see your Four Winns Dealer.
3. Once a month, inspect both the clip and lanyard for cuts, breaks or wear. Replace worn or damaged parts.

In an emergency situation, any occupant of the boat can restart the engine. Just press in and hold the emergency stop switch button, then follow normal starting procedures. When the button is released, the engine will stop.

 **WARNING**

Avoid knocking or pulling the clip or lanyard from the switch during regular boating operation. Occupants may be thrown forward or possible engine damage may occur by the sudden loss of engine power.

K. Alarm Systems

Engine alarm systems are available on most models. The alarm is audible and is actuated by various engine sensors. The sensors monitor such things low oil pressure, high water temperature levels and high exhaust manifold temperatures. Consult your engine owner's manual for information regarding the specific systems monitored by the alarm if so equipped.

L. Compass

A compass is available on certain F series models. The compass can provide directional information when operating offshore, in unfamiliar waters, or in adverse weather conditions.

The compass must be properly calibrated after all personal equipment is installed including all electronics (radio, depth sounder, etc.). DO NOT rely on the compass readings until initial adjustment (compensation) has been performed. If the boat has a factory-installed compass, the manufacturer's instructions are provided in the owner's packet. Most areas have local companies that specialize in compass adjustment. If unsure of the proper compensation techniques, consider having the adjustment done professionally to ensure accuracy and confidence in the compass.

NOTICE

During use, keep all extraneous metal objects away from the compass. The close proximity of metal objects (e.g., beverage cans) can cause compass deviation.

M. Instrument Maintenance

Electrical protection for instruments and ignition circuitry is provided by fuses. The fuse block is typically located underneath the starboard dash on most models.

Periodically, spray the ignition switch with a contact cleaner. The ignition switch and all instruments, controls, etc. should be protected from the weather when not in use. Four Winns offers appropriate weather covers for each model. Excessive exposure can lead to gauge and ignition switch difficulties.

CAUTION

DO NOT use a product such as WD-40 as a contact cleaner. Be sure to read the label before using any product.

Electronic gauges are affected by static electricity that builds-up on the glass face. Periodic washing on the gauge face with warm water and mild liquid detergent will help eliminate the static electricity problem and improve gauge accuracy.

NOTICE

Four Winns continually strives to improve its products. Unit specifications, including standard and optional equipment are constantly being modified. Equipment availability is also subject to change without notice. The most current and accurate information available at the time of publication is included in this manual. Some variation in equipment, description, location, and details can result.



F - 1 GENERAL

Control systems permit operation of the engine's throttle and shift mechanisms. Typically, they consist of three major components; the control, the throttle and shift cables. Note: On certain models which include an electronic shifter the control cable is replaced by a CAN-bus type of electronic system. CAN stands for Control Area Network.

The F series stern drive models are equipped with single engine side-mount control with trim. This allows you to select forward or reverse gear, regulate engine speed, and ensure shifting is done at low engine speed. See Figures F1 and F2. Moving the lever forward will shift the drive into forward. Moving it aft will shift the drive into reverse. Moving the lever further will increase engine speed.

A "start-in-neutral-only" feature which prevents starting in gear is included. Refer to F-3 Neutral Safety Switch in this section. Also, the side mount control has a neutral lock button to prevent accidental shifting. It must be pressed to permit shifting from neutral to forward or reverse. See Figure F1.

NOTICE

Side-mount controls will vary based on engine type and manufacturer.

Built into the control is a trim control which you can use to adjust the position of the outdrive. See Figure F1. Pressing the switch in the UP position moves the outdrive out and away from the transom. Pressing the switch in the DOWN position moves the outdrive in closer to the transom. The switch returns to its center neutral position when released. For additional information see Section E-5.

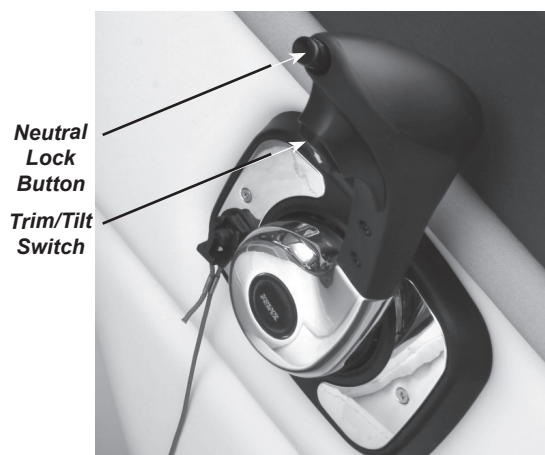

Figure F1: Side-Mount Control - Models May Vary



**Figure F2: Helm Station
(Representative View - Models May Vary)**

NOTICE

Allow the engine to warm up before engaging the shift control. Monitor all instruments while engine is idling during warm up.

F - 2 CONTROL OPERATION
A. General
NOTICE

The control information included in this section is general only. For specific operation of the controls on your boat, refer to the control manufacturer's literature and engine manufacturer's literature included in your owner's packet. Ensure you completely understand the operation of the controls before operating your boat. Also consult your dealer should any questions arise regarding the operation of the control unit.

NOTICE

If your boat is equipped with a non-OEM remote control system, ask your dealer how to properly operate it.

NOTICE

Reduce throttle as soon as motor starts. Do not run a cold motor any faster than necessary to keep motor from stalling. Do not exceed 2000 RPM in NEUTRAL.

B. Maneuvering of Side-Mount Control

Shifting and engine speed are controlled with the same lever (1). See Figure F3.

N - Neutral position. Drive/Reverse gear disengaged.

F - Drive/reverse gear engaged for forward movement (ahead).

R - Drive/reverse gear engaged for backward movement (astern).

T - Engine speed control.

Trim/Tilt Switch - Push top of switch or where indicated to trim out and tilt up, or push bottom of switch or where indicated to tilt down and trim in.

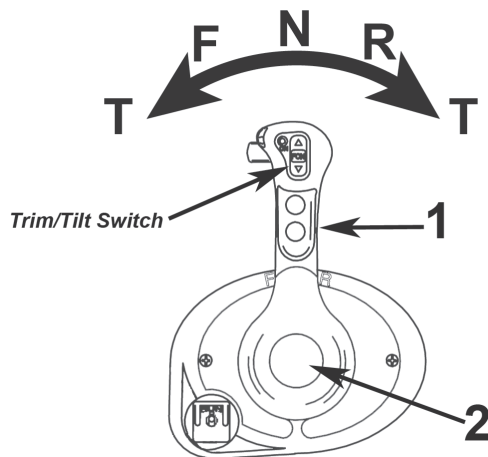

Figure F3: Side-Mount Control Operation

To disengage the shift function:

- 1) Move lever (1) to the neutral position (N).
- 2) Press in button (2), press the gear shift release lever and move the lever slightly forward and release the button.

The shift function is now disengaged the lever only effects engine speed. When the lever is moved back to the neutral position it will automatically re-engage the shift function. The shift function is then enabled.

C. Shifting and Control Speed

1. Move shift/throttle lever to the neutral idle position. Placing the shift/throttle lever in the neutral detent position will engage neutral start switch and allow engine to start.

NOTICE

For additional information, refer to the section on "Starting and Operation" in the engine manufacturer's manual.

CAUTION

DO NOT shift into FORWARD or REVERSE unless engine is running. Damage to the shift system could result from trying to shift without the engine running. Carefully check function of all control and engine systems before leaving the dock.

2. To go FORWARD - move the shift/throttle lever forward. Once forward gear engagement is complete, push shift/throttle lever forward until desired speed is achieved.
3. To go in REVERSE - move the shift/throttle lever rearward. Once rearward gear engagement is complete, push shift/throttle lever rearward until desired speed is achieved.

WARNING

DO NOT shift from forward to reverse when the boat is planing.

NOTICE

DO NOT shift if engine speed is above 800 RPM.

4. To go from FORWARD to REVERSE, or REVERSE to FORWARD; always pause at NEUTRAL and allow engine speed to return to idle.
5. After shifting is completed, slowly push shift/throttle lever forward/rearward until desired speed is achieved.

 **WARNING**

Any time the boat is operated, be aware of changes in shift system operation. A sudden increase in shift effort of the shifter lever, or other abnormal operation, indicates a possible problem in the shift system. If this occurs, the following precautions must be taken:

- *With engine running and boat securely tied to the dock, shift drive into forward and reverse to ensure there is gear engagement.*
- *When docking the boat, all docking maneuvers must be performed at slow speed. Pay special attention to other boaters. Passengers should be informed of potential problems and precautions taken.*

If you suspect there is a problem, see your MerCruiser® or Volvo Penta® dealer as soon as possible for proper diagnosis and required service or adjustment. Continued operation could result in damage to the shift mechanism and loss of control.

F - 3 NEUTRAL SAFETY SWITCH

Every control system has a neutral safety switch incorporated into it. This device prohibits the engine from being started while the shift lever is in any position other than the neutral position. If the engine will not start, slight movement of the shift lever may be necessary to locate the neutral position and disengage the safety cutout switch. Control or cable adjustments are required to correct this condition should it persist. See your Four Winns dealer for necessary control and cable adjustments.

F - 4 CONTROL SYSTEM MAINTENANCE

Periodic inspections of the controls, cables, and all connections should be made. Signs of looseness, rust, corrosion, wear, cable jacket cracks or other deterioration require immediate system servicing. Replace all damaged components.

Generally, periodic lubrication of all moving parts and connections with a light, waterproof grease is in order. Cables can be lubricated by positioning them to their fullest extension and applying light grease to the inner cable near the jacket. Working the cables back and forth will distribute the grease in the inner cable. Reapply the grease if necessary.

Lubrication should be performed as often as necessary to keep the system operating smoothly. Cable manufacturers such as Teleflex® and Morse® often offer special tools to make cable lubrication easier.

Cable and control adjustments may become necessary. Adjustment screws in the control, on the cables and in the linkage are provided.



G - 1 GENERAL

Four Winns® boats are equipped with a rotary steering system. Tilt and power steering are available on the F series models.

A. Rotary Steering

In the rotary system, a rotary drum assembly is mounted under the dash behind the steering wheel with a one-piece cable running through the boat into the engine compartment. At the transom, the cable turns and is connected to the engine.

B. Tilt Steering

If equipped with tilt steering, depress the release lever (adjusting tab) with your thumb to tilt the steering wheel. Be sure to hold the top of the wheel to assist in positioning. Release the lever once the steering wheel is in the position desired. See Figures G1 and G2. Refer to the steering manufacturer's literature, included in the owner's packet, for additional information.

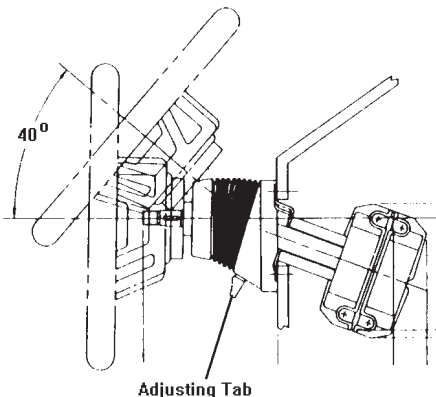

Figure G1: Tilt Steering



Figure G2: Adjusting Tab

WARNING

The tilt mechanism should not be adjusted when the boat is moving. Sudden boat movement may cause loss of balance resulting in loss of control and/or injury.

WARNING

*The tilt mechanism is spring loaded. Due to the variation in steering wheel offerings, the wheel may spring up rapidly when depressing the release lever. **ALWAYS KEEP ONE HAND ON THE WHEEL DURING TILT ADJUSTMENT OR INJURY MAY OCCUR.***

C. Power Steering

Power steering, featured on F series models, is comprised of an engine-mounted pump, hoses and steering cylinder. Power steering works in conjunction with the helm and steering cable to move the transom mount tiller arm and vertical drive more smoothly.

This is a "power assist" system and can greatly reduce steering effort required. It is not, however, a full power steering system as is used in automobiles. Some steering tension remains in the system.

Restricting movement of the steering cable will limit or stop the steering system's hydraulic assist.

NOTICE

***DO NOT** interfere with or restrict steering cable movement through the last 90° of bend at the engine. **DO NOT** use cable retainers, clamps or tie straps. Using one or all of these could restrict the cable movement near the engine. **DO NOT** tie wiring harnesses or other control cables to the steering cable. Make sure the deck coaming pads and bulkheads allow for steering cable movement in all positions of trim.*

If the power steering becomes inoperative, steering will be harder and more effort will be needed to steer the boat. Check for a broken or loose belt on the power steering pump. Also, low fluid levels in the power steering pump reservoir will cause hard steering. If these items are not the source of the problem, check for equipment or other items lying on or up

against the steering cable at the back of the boat. The cable must be free and clear to slide back and forth. Any item blocking free movement of the cable will result in harder steering and possible damage to the steering cable.

If the power steering system cannot be corrected on board, proceed at a reduced speed. The boat will be steerable, but with increased effort. Return the boat to your Four Winns dealer as soon as possible to correct the power steering system.

 **CAUTION**

Check the power steering fluid level in the reservoir periodically. Low power steering fluid levels may increase steering difficulty.

 **CAUTION**

After the first two hours of running time, check the entire steering system for loose bolts, nuts and fasteners which could adversely affect steering control.

NOTICE

When storing equipment in the engine compartment, be sure to avoid contact with the steering cable. Cables may become kinked or damaged and may increase steering effort.

NOTICE

DO NOT force the steering unit to either extreme. This can place undue strain on the unit and can lead to hydraulic line or seal failure.

It is important that the power steering fluid be maintained at the proper level. Do not over fill the power steering pump reservoir. Please consult the section in the engine manual regarding steering system and maintenance. The engine manual is included in the owner's packet.

G - 2 PROPELLER TORQUE

The propeller rotation of a single engine operation will exert a directional force on the steering system. Propeller torque can also cause the boat to wander (not follow a straight line) when operated at low speeds. This condition is normal and can be corrected only by increasing engine RPM. Wind, water currents and play in steering components can cause equivalent effects.

 **CAUTION**

Steering effort can vary significantly with engine acceleration, steering angle, trim angle, and sea condition. Be prepared for additional steering loads at all times.

G - 3 STEERING SYSTEM MAINTENANCE

A. General Maintenance

A periodic inspection of all steering cables, linkage and helm assemblies should be made. Signs of corrosion, cracking, loosening of fastenings, excessive wear, or deterioration should be immediately corrected. Failure to do so could lead to steering system failure and corresponding loss of control.

NOTICE

Check all bolts, nuts and fasteners for tightness.

B. Rotary System Maintenance

The helm and cable assembly should be so adjusted that the steering wheel is centered with the drive or outboard engine in the straight ahead position. There should be an equal number of turns to port and starboard from the straight ahead position. If adjustment becomes necessary, see your Four Winns dealer.

Check all metal parts at the cable output end for corrosion. Remove any old grease from the cable ram and motor swivel connections using a mild solvent such as WD-40. Spray the cleaned areas with a moisture-displacing lubricant and apply a light coat of good quality marine grease. Do this with the ram fully extended. See Figure G3.

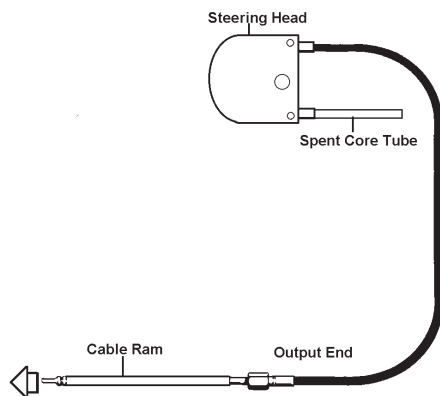

Figure G3: Steering Cable

C. Winter Storage

If the boat is placed in winter storage or used infrequently, clean the cable ram as instructed earlier. Cycle the steering several times when applying lubricant. If at any time the steering system becomes stiff, has an excessive amount of free play or shows any change in its operating characteristics, contact your Four Winns dealer to have the system inspected.



H - 1 GENERAL

All electrical equipment on the Four Winns F series models operates on 12 volts DC. The F series models come equipped with dual battery system depending upon the model. The batteries are located either in the port or starboard engine compartments again depending on the model. See Figure H1.

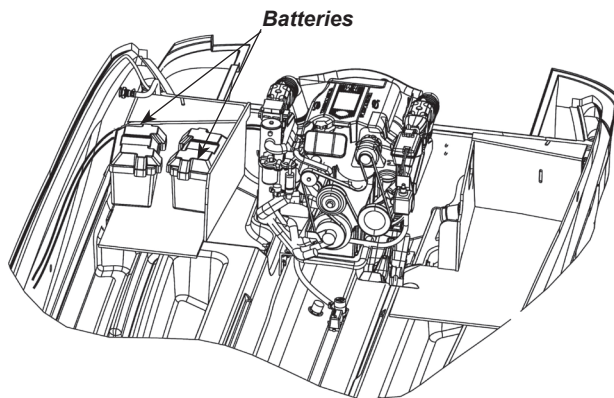

Figure H1: Dual Battery Location Shown
(Representative View - Models May Vary)



WARNING

Fire or Explosion Hazard!

Electrical system parts are designed and manufactured to comply with the US Coast Guard requirements to minimize risks of fire or explosion. **Never substitute automotive parts for marine parts.** Automotive parts do not provide the necessary ignition spark protection.



WARNING

DO NOT tamper with any electrical connection, panel or harness, or attempt installation of any electrical equipment unless thoroughly familiar with the systems and experienced in making such installations.

On F series models equipped with dual batteries and a battery switch, the boat has a designated battery for the ship's systems and for the engine. Circuit breakers are installed on the panel to protect various system component circuitry. The SHIP SYSTEMS breaker supplies power to all DC electrical components with the exceptions of aft bilge pump, stereo memory, exhaust, and stereo amplifiers. The circuit breakers and fuses are labeled for amperage and use. See Figures H2 & H3.



Figure H2: Battery Switch Panel - Stbd Stern Seat Storage
(Representative View - Models & Locations May Vary)

NOTICE

Listed on the battery switch panel are various labels for the circuit breakers protecting different components. A particular label does not necessarily mean your boat is equipped with this component if either the component is optional or not available to that particular model. Please see your Four Winns dealer for details.

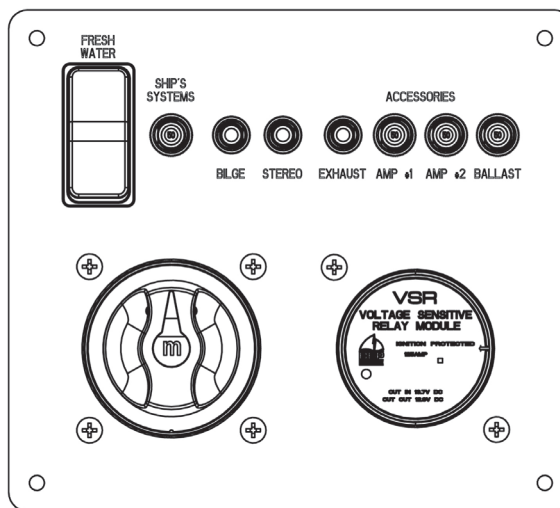

Figure H3: Battery Switch Panel
(Representative View - Models May Vary)

H - 2 SINGLE ENGINE - DUAL BATTERY SYSTEM

A battery selector switch is installed when the boat is equipped with a dual battery system. As previously mentioned in Section H-1, each, the ships' systems and engine, has an individual battery designated to it.

A. Installation

1. Connect each of the red (positive) battery cables leading from the battery selector switch to the positive (+) terminal on each of the two batteries.

NOTICE

Be sure the two red (positive) cables are installed on the positive (+) battery terminals.

2. Connect each of the black or yellow (negative) battery cables leading to the engine block to the negative (-) battery terminal on each of the two batteries.



WARNING

When disconnecting the cables from the battery, make sure all switches are off and disconnect the black or yellow negative cable(s) first to prevent spark.

B. Battery Switch Operation

Power to the engine and all 12 volt electrical equipment is controlled at the battery switch panel. Separate circuit breakers are provided on the battery selector switch panel to protect the aft bilge and forward bilge pumps, shower sump, stereo memory, exhaust, and stereo amplifiers (if applicable). See Figure H3.

As described by the manufacturer, the battery switch (See Figure H6) makes it possible to switch two battery banks simultaneously with one single ON/OFF switch. It eliminates the confusion surrounding the traditional four-position selector battery switch. The battery switch offers simple ON/OFF switching and the isolated engine start and ship's systems (house) circuits reduces the chance of fully discharging both batteries. It also protects house electronics from engine starting sags and spikes as well as protecting engine electronics controls from stray house line noise.

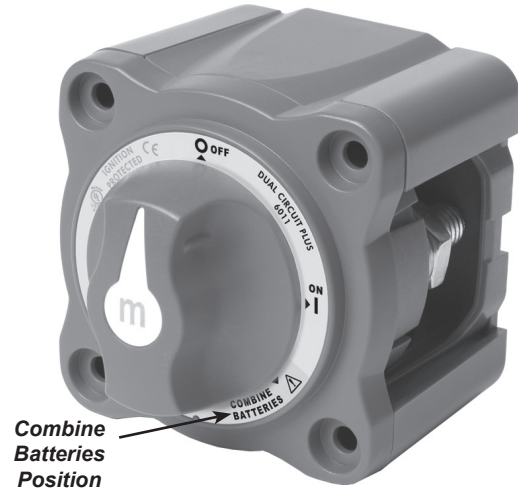

Figure H6: Battery Switch
(Representative View - Models May Vary)

A description of the various positions for this battery switch is as follows:

“OFF” - With the battery selector switch in the “OFF” position, all 12 volt power to the boat is shut off completely except to the automatic bilge pump and stereo memory. A separate circuit breaker is provided on the battery switch panel for the automatic bilge pump. Always turn the battery selector switch to the “OFF” position when the boat is removed from the water.

NOTICE

DO NOT turn or “pass” the battery selector switch to the “OFF” position while the engine is running. Alternator and wiring damage could result.

“ON” (I) - When the battery switch is set to “ON”, current flows from the engine (start) battery to the engine start circuit, and from the ship's systems (house) battery to the ship's systems circuits.

“COMBINE BATTERIES” - When the battery switch is set to “COMBINE BATTERIES”, current flows from both ship's systems and engine batteries to ship's systems and engine circuits. The “COMBINE BATTERIES” function offers the ability to combine the two battery banks in the event of a low start battery. It also makes it possible to charge both batteries when the alternator is charging.

NOTICE

The panel is equipped with a voltage sensitive relay (VSR) to allow charging of both batteries when the alternator is charging.

H - 3 VOLTMETER

A voltmeter is typically incorporated into the “four-in-one” gauge which is installed in the dash panel to monitor the condition of the engine battery. Additional information on the voltmeter may be found in the engine owner’s manual.

H - 4 12 VOLT ELECTRICAL EQUIPMENT

A. Helm Equipment

The ignition circuit is protected by circuit breaker located on the ignition switch panel itself. See Figure H7. Port and starboard switch panels are labeled for ease of identification. Many of the helm panel switches have a built-in LED which lights up when the switch is placed in “ON” position. This feature helps the operator know whether or not a component has been activated, especially in low-light situations. See Figure H8. Note: Helm and switch panels may vary by model.

The 12 Volt DC outlet and helm switch circuitry are protected by a separate fuse panel located underneath the helm console. Access to the fuse panel may be gained by going underneath the helm console. Figure H9 depicts the fuse block along with the fuse schedule. Both the function and fuse rating are also identified on the fuse panel. Note: Fuse panels may vary by model.

WARNING

To avoid electrical problems, equipment damage or electrical fires, use only replacement fuses or breakers that are of equal rating to the originals.



Figure H7: Ignition Switch Panel



Figure H8: Helm Switch Panel

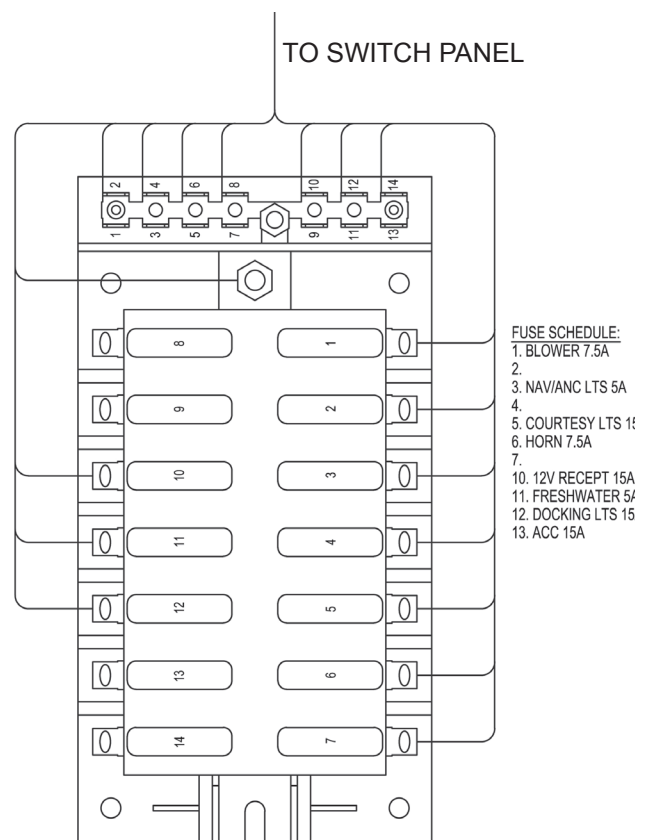

**Figure H9: Fuse Block with Fuse Schedule
(Representative View - Models May Vary)**

To assist you, we have listed the descriptions of individual switches, receptacles and their uses:

Accessories - Additional 12 volt equipment may be added to the boat by using the accessory switches (ACC). Certain options or accessories may be wired to the helm circuit breaker panel. See Figures H4 and H5. For additional information on adding accessories, refer to Section H-4B.

12 Volt DC Receptacle - Permits the use of additional 12 volt equipment such as a cell phone. Using the appropriate adaptor, the equipment draws power from the ship's system battery. A 12 Volt DC receptacle is located at the helm.

Aft Bilge Pump - The BILGE switch is used to manually activate the bilge pump in the engine compartment. The bilge pump is used to remove water from the bilge (bottom of the hull) area of the boat by pumping that water overboard. The aft bilge pump is equipped with an automatic bilge switch and will operate whenever bilge water rises to a level that will cause the float to move upward.

This automatic bilge pump is active even if the battery selector switch is in the "OFF" position. The automatic bilge pump circuitry is connected directly to the battery. When leaving your boat unattended for an extended period, check the charge on the battery periodically. Also check the water level in the bilge and make sure the float switch is functional.

If the automatic bilge pump must be disabled, disconnect the wiring plug near the bilge pump.

Blower - The BLOWER switch is used to activate the bilge blower. Toggle the switch to the "ON" position, activates the electric bilge blowers, changing the air in the engine compartment that may contain gas vapors.

 **WARNING**

Gasoline vapors can explode resulting in injury or death. Before starting the engine, check engine compartment bilge for gasoline or vapors. Operate blower for four minutes, and verify blower operation. ALWAYS run the blower when the vessel is operating below cruising speed.

Courtesy (Cockpit) Lights - The CTSY LTS switch is used to activate the courtesy lights.

Horn - To sound the horn, press the HORN switch.

Navigation & Anchor Lights - Toggle "UP" activates the bow lights, the all-around light and the instrument lights on the dash. Toggle "DOWN" to activate the all-around light. The center switch position is "OFF".

Docking Lights - The docking lights (if equipped) may be activated by moving the push-button "DOCKING LTS" switch to the "ON" position.

Trim Tabs - If the boat is equipped with electric/hydraulic trim tabs, the trim tabs are controlled by the TRIM TAB switches. Refer to Section E-6 - Trim Tabs for more information.

Wiper - The WIPER switch activates the optional starboard windshield wiper. The wiper will self park.

Transom Trim Switch - If equipped, this switch is installed at the transom of the boat. This switch allows one to trim the outdrive up or down from the transom conveniently by pressing the switch in the desired direction. See Figure H10.



Figure H10: Transom Trim Switch

B. Installation of Additional 12 Volt Equipment

Non-factory installed 12 volt accessory equipment can be connected to the "ACC" switch(s) on the dash.

 **CAUTION**

Be sure to provide proper fuse or circuit breaker protection for all 12 volt equipment that is installed. DO NOT overload the accessory circuitry by installing too much additional 12 volt equipment.

C. Interior Equipment

Stereo - On the F series models, the AM/FM/CD stereo is mounted on the helm. See Figure H11. The face plate opens to access the CD slot. See Figure H12. The speakers are installed within the side bulkheads or seat bases depending on the model.

A stereo remote is available and is installed at the transom. If equipped, one can control the stereo functions conveniently without having to go to the helm. See Figure H13.



Figure H11: Stereo



Figure H12: Stereo CD Slot



**Figure H13: Transom Stereo Remote
(Representative View - Models May Vary)**

NOTICE

Four Winns continually strives to improve its products. Unit specifications, including standard and optional equipment are constantly being modified. Equipment availability is also subject to change without notice. The most current and accurate information available at the time of publication is included in this manual. Some variation in equipment, description, location, and details can result. Please refer to the manufacturer's literature in the owner's packet.

H - 5 12 VOLT ELECTRICAL SYSTEM SHUTDOWN PROCEDURES

When leaving your boat unattended for an extended period of time it is advisable to shutdown the electrical system to reduce battery drainage and/or possible electrical draw.

1. Turn Ignition key to the "OFF" position and remove key.
2. Turn the battery switch (if applicable) to the "OFF" position.
3. Move the SHIP SYSTEMS circuit breaker switch (if applicable) to the "OFF" position.

H - 6 ELECTRICAL SYSTEM MAINTENANCE

A. Battery Maintenance

Be sure to keep the batteries charged. Also, keep the batteries clean, especially the terminals and connection lugs. Be sure the batteries are fastened securely while in use.

Check the battery fluid level often, especially when a charger/converter is being used. Replenish a battery indicating a low charge. Determine the reason for the discharge. Lack of battery usage is as detrimental to battery longevity as is overuse. Alternating battery usage is important. Refer to the battery manufacturer's instructions included with your battery.

 **DANGER**

Batteries produce hydrogen and oxygen gases when being charged. These explosive gases escape through the vent/fill caps and may form an explosive atmosphere around the battery if the ventilation is poor. This gas may remain around the battery for several hours after charging. Sparks or flames can ignite the gas and cause an explosion.

 **WARNING**
Fire or Explosion Hazard!

Only qualified personnel should install batteries and perform electrical system maintenance. Do not expose batteries to open flame or sparks. Do not smoke near batteries.

 **WARNING**
Poison!

Sulfuric acid in batteries can cause severe burns. Avoid contact with skin, eyes, or clothing. Wear goggles, rubber gloves and protective apron when working with batteries. In case of skin contact, flush with water at least 15 minutes. If swallowed, drink large quantities of water or milk. Follow with Milk of Magnesia, beaten egg or vegetable oil. Get medical attention immediately.

 **WARNING**

Disconnect the battery before working on electrical or ignition system to prevent electrical shock and accidental ignition.

B. Electrical Wiring Maintenance

Periodically, inspect all wiring for nicks, chafing, brittleness, improper support, etc. Spraying the electrical connections with an electrical connection cleaner will reduce corrosion and improve electrical continuity.

 **WARNING**

DO NOT allow corrosion to build up on connections. This can cause equipment to operate improperly.

The American Boat and Yacht Council (ABYC) has published a standard for the color coding of boat wiring. Four Winns voluntarily complies with these standards so a qualified service technician can install new equipment or troubleshoot the electrical system. The following table (Figure H14) summarizes the color code system:

Wire Color	Wire Designation
Red	Wires on positive (+) side of battery that go to starter. This wire is non-protected.
Red/Purple Stripe	50 amp protected wire that runs from the engine to the fuse panel at the helm.
Yellow/Red Stripe	Wire from starter switch to starter solenoid.
Brown/Yellow	Power lead to bilge blower from a fuse or switch.
Dark Gray	Sensor wire from tachometer sender to tachometer.
Brown/Orange	Leads to bilge pump from switch.
Brown/Red	Leads to auto bilge pump.
Purple	Wire between ignition switch and coil. Wire from ignition switch through distribution panel to electrical instruments.
Orange	Accessories
Dark Blue	Wire from switch to instrument lights.
Light Blue	Sensor wire from engine oil pressure sender to oil pressure gauge.
Tan	Sensor wire from water temperature sender to water temperature gauge.
Pink	Sensor wire from fuel tank level sender to fuel gauge.
Purple/White	Trim position
White/Green	Trim down
White/Blue	Trim up
White/Red	Trim power
Yellow	Ground
Gray/Green	Bow light
Gray/Blue	Stern light

Note: Some of these colors can serve more than one type of circuit.

Figure H14 Wiring Color Codes

H - 7 STRAY CURRENT CORROSION

A. General

Electrically induced underwater corrosion occasionally affects boats and their related components. This is referred to as “Stray Current Corrosion” and appears as surface pitting or deterioration. Stray current corrosion is the decomposition of chemical compounds by electric current.

Stray current corrosion can be caused by the polarity of the dockside wiring system of the boat being reversed from the power source (reversed polarity) or surrounding boats, an improperly wired battery installation, other boats that are in close proximity that have electrical power leakages, or any other source close to the boat that has electrical power leakage into the water. Stern drive units are especially vulnerable to stray current corrosion.

Periodically inspect the drive components and thru-hull fittings to determine if stray current corrosion damage exists. If corrosion damage is found, determine and correct the cause of stray current to prevent further damage. Consult an experienced marine electrician or contact your Four Winns dealer for assistance.

The use of some shore power battery chargers while the boat is in the water and the battery is connected to the system can cause stray current corrosion. Have an experienced marine electrician review any battery charger installation to ensure a stray current corrosion problem will not develop. An improper battery connection is a common cause of stray current corrosion.

NOTICE

Use only UL Marine – ignition protected battery chargers. Consult your Four Winns Dealer for recommendations.

Corrosion is usually more prevalent in polluted or salt water than in fresh water. It is also more likely to occur when dockage is in an area with steel piers, large metal boats, or where shore power is in use.

B. Galvanic Corrosion

Galvanic corrosion results from a potential electrical difference existing between dissimilar metals immersed in a conductive solution (e.g., salt or brackish water). If these metals touch or are otherwise electrically connected, this potential difference produces an electron flow between them. The attack on the more active metal is usually increased and the attack on the less active metal is decreased, as compared to when these metals are not touching.

C. Corrosion Prevention

Anti-corrosion anodes are attached to the bottom of the gimbal housing to prevent corrosion to your stern drive and underwater parts. These anodes will be slowly eroded away by galvanic action and require periodic inspection. Please refer to the section on “Anti-Corrosion Anodes” or “Corrosion and Corrosion Protection” in your engine manufacturer’s manual for additional information. The engine manual is included in the owner’s packet.



I - 1 GASOLINE FUEL SYSTEMS

A. Fuel System - Domestic Models

For domestic models, the equipment used by Four Winns, as described by the manufacturer, is designed to provide maximum engine fuel flow and minimize hydrocarbon emissions. Overfill protection helps prevent the possibility of accidental fuel spills. The fuel system on the F series models have automotive style refueling, to include automatic nozzle shut off and fuel nozzle retention. **Note:** The automatic shut off feature only exists when dispensing fuel with an auto shut off nozzle.

These F series models include an integrated fuel system which utilizes a carbon canister. See Figure I1. As the fuel tank is filled with gasoline, pressure rises in the fuel tank. To prevent over-pressurization, the fuel limit vent valve expels pressure (which includes gas vapors) that travel through the fuel vent hose. Before escaping, the vapors are scrubbed by first passing through the carbon canister. See Figure I2.

When a predetermined level has been reached the fuel limit vent valve shuts off. Pressure quickly builds in the tank and the fuel fill inlet control closes. Fuel no longer can enter the tank. As the fuel level rises in the fill hose it shuts off the fuel flow from the fuel nozzle (just like when you fill your car's fuel tank).

NOTICE

Gasoline fuel systems used in Four Winns® domestic boats are designed to meet or exceed the requirements of the Environmental Protection Agency (EPA), US Coast Guard, California Air Resources Board (CARB), the National Marine Manufacturers Association, and the American Boat and Yacht Council in effect at the time of manufacture.

WARNING

*Avoid overboard spills. Be alert. The fuel nozzle should automatically shut off when using an automatic shut off nozzle. Be ready in the event it does not or if you are using a different type of nozzle for dispensing fuel. **DO NOT TOP OFF.***

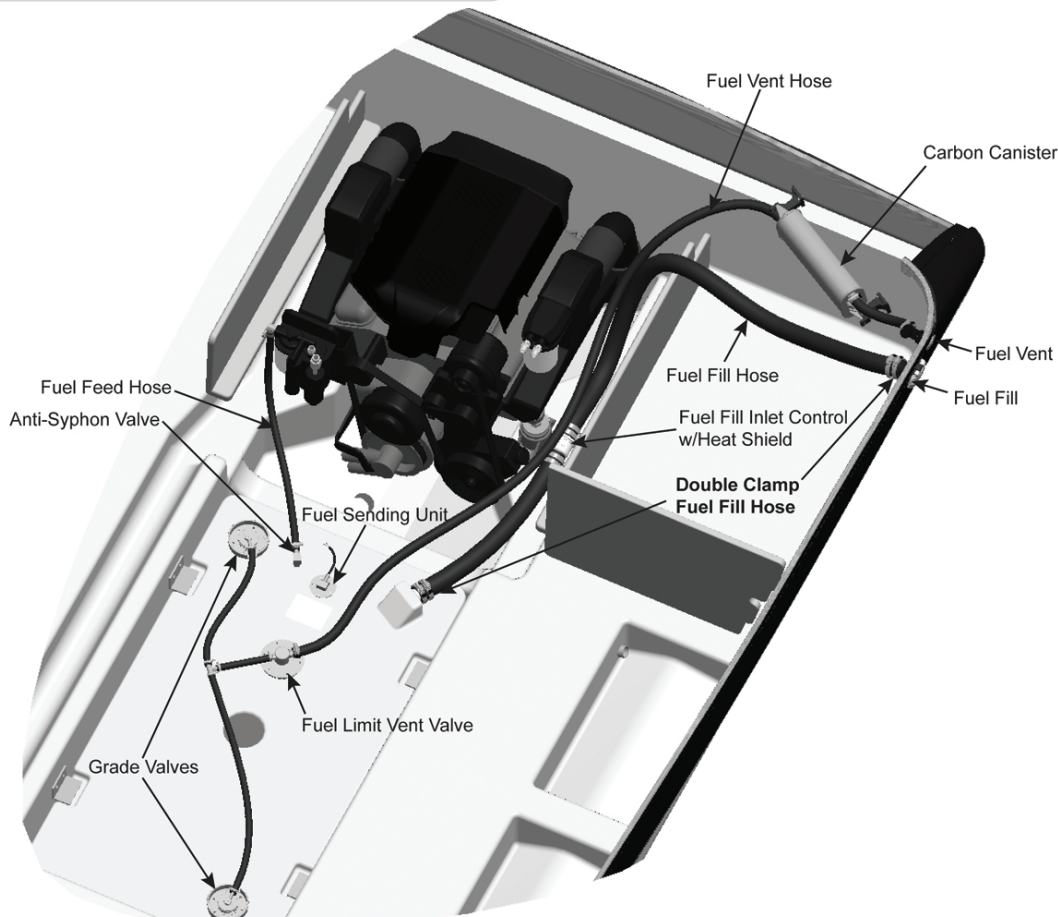

Figure I1: Fuel System Components - Domestic Models
(Representative View - Models May Vary)

When the pressure reduces in the fuel tank the fuel fill inlet control opens and allows the remaining fuel in the fuel line to drain into the fuel tank.

It should also be noted that when the air temperature rises so does the pressure in the fuel tank. When this happens the pressure is released through either the fuel limit vent valve or the grade valves depending upon the level of the fuel in the tank. Either way the gas vapors are scrubbed by the carbon canister before being released into the air. As the temperature drops, air is brought back in through the fuel vent allowing the system to breath.

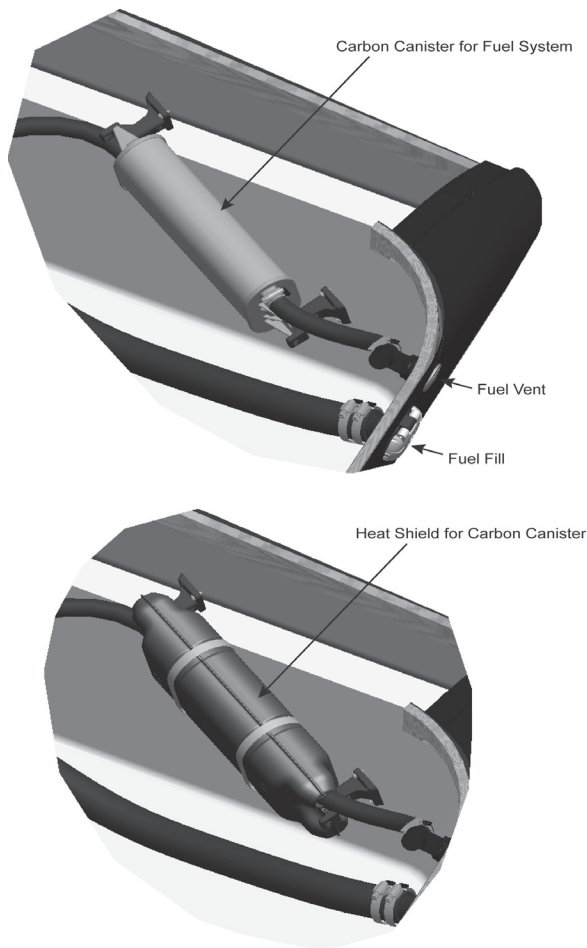

Figure 12: Carbon Canister w/Heat Shield

On both Four Winns® domestic and export models, with a single fuel tank installed, the location of the tank is forward of the aft bilge compartment below the floor. Please visit our website at www.fourwinns.com for fuel tank capacities. See Figure I3.

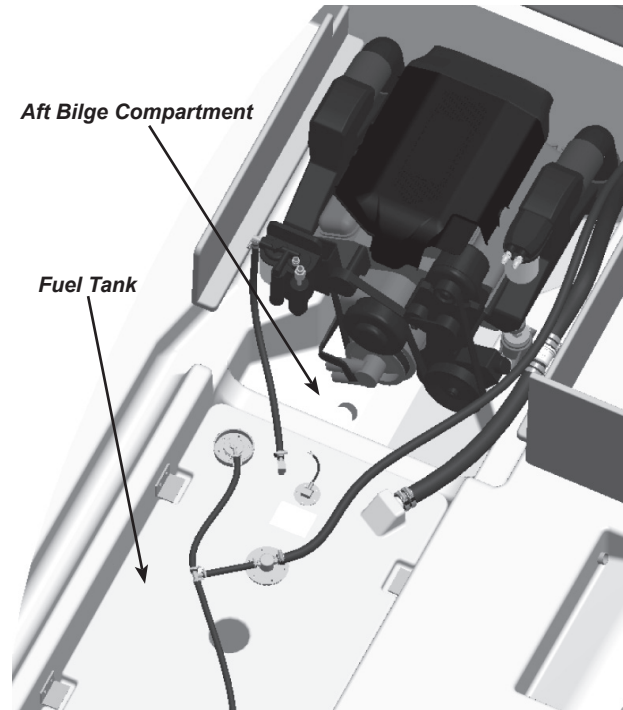

Figure 13: Fuel Tank Location
(Domestic Fuel System Shown - Models May vary)

NOTICE

Use only clean fuel of the type and grade recommended by the engine manufacturer. Engine damage resulting from the use of a lower octane gasoline is considered misuse of the engine and will void the engine warranty. Refer to the section on gasoline requirements in the engine manual for information on octane specifications.

B. Fuel System - Export Models

For export models the equipment used by Four Winns is designed to provide maximum engine fuel flow and prevent the accidental system over-pressurization by the use of a vented gas fill. It should be noted that there is **not** an automatic nozzle shut-off feature as with the domestic fuel system. When filling the fuel tank, strict attention must be observed to prevent the possibility of a fuel spill. See Figure I4.

WARNING

Avoid overboard spills. When tank is almost full the sound from the fuel fill/vent will change. The pitch will become higher indicating the tank is close to being full. Stop pumping fuel into tank. **DO NOT TOP OFF.**

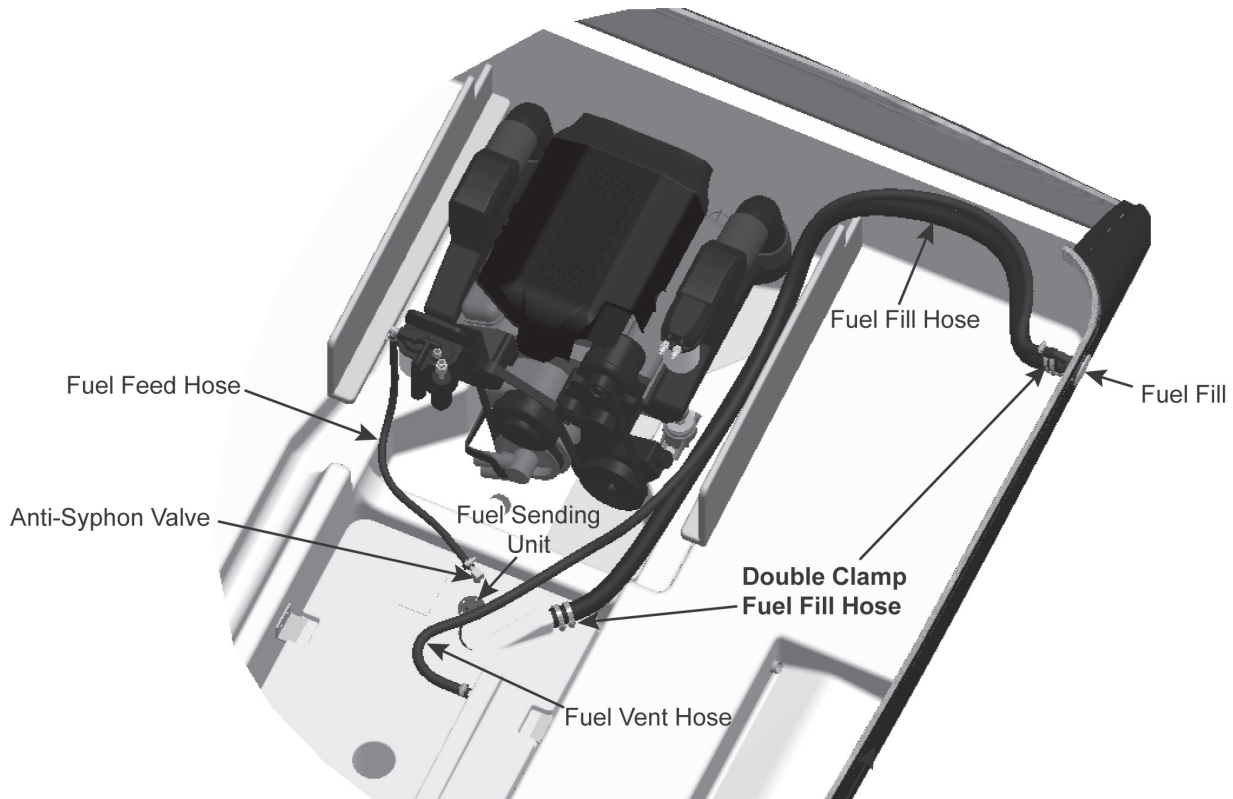

Figure 14: Fuel System Components - Export Models
(Representative View - Models May Vary)

C. System Testing

All gasoline fuel systems have been factory inspected and pressure tested in accordance with regulations in effect at the time of manufacture. Additionally, each fuel tank must pass rigid tests and inspections performed by the fuel tank manufacturer.

Prior to taking delivery, it is important that a full inspection be made of the entire fuel system by the selling dealer. An entry on the Four Winns® Pre-Delivery Inspection Form portion of the online Warranty Registration will attest to the dealer's performance of this service.

D. Fuel Fills - Domestic Models

Fuel deck fills are located either on the aft deck or side decks, and are clearly marked with a fuel symbol or are labeled "GAS". See Figures I1, I5, & I6. The fuel deck fill is hinged to prevent loss. It is designed for nozzle retention, are automatically shut-off compatible and includes dual over pressure relief valves. The water-resistant gas cap prevents water from entering the fuel system.

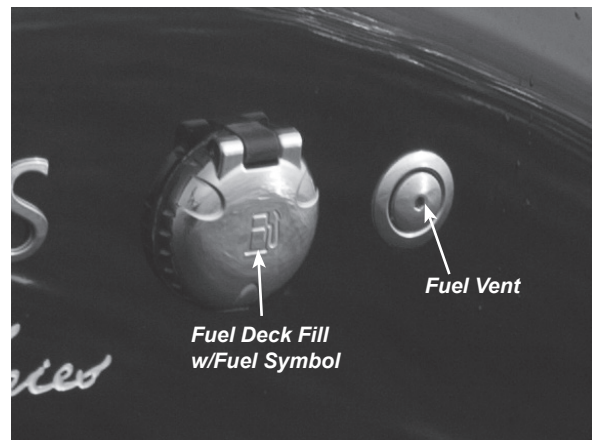

Figure 15: Fuel Deck Fill & Fuel Vent - Domestic Models

The "click-to-close" gas cap allows for ease of use. To open, push the catch/release mechanism shown in Figure I6 inward. To close, simply shut the cap and press the cap until it "clicks" shut. Hearing the click ensures that the gas cap is completely closed. Be sure to utilize the proper type and grade of fuel as recommended by the engine manufacturer. See Section I-2 for additional information.



Figure 16: Fuel Deck Fill Catch/Release Mechanism - Domestic Models

NOTICE

All connections, including the fuel deck fill, should be checked annually for leaks.

 **WARNING**

DO NOT confuse “GAS” deck fill with “WATER” or “WASTE” deck plates. Deck fill plates are labeled according to the intended use.

 **WARNING**

Spilled fuel is a fire hazard. DO NOT overfill or overflow the tank, or allow fuel spills into the hull or bilge. If spillage occurs, clean up immediately and dispose of soiled rags/towels in a proper container.

NOTICE

When fueling at a marina, DO NOT overfill. Fuel may spill into the water.

 **WARNING**

Avoid overboard spills. Be alert. The fuel nozzle should automatically shut off when using an automatic shut off nozzle. Be ready in the event it does not or if you are using a different type of nozzle for dispensing fuel. **DO NOT TOP OFF.**

After fueling, close the fill cap, and wash the areas around the fuel fill cap. Residual fuel left on the deck and hull sides can be dangerous and will yellow the fiberglass. It can also damage the tape stripes and logos. Care should be taken, when cleaning, to prevent contaminating the fuel vent and deck fill. Cleaning with only mild soapy water is recommended.

E. Fuel Vents - Domestic Models

On the F series models, separate thru-hull P-trap fuel vents are installed. See Figures 17. While the tank is being filled, the air displaced by the fuel escapes through the vent overboard.



Figure 17: P-trap Fuel Vent (Representative View - Models May Vary)

When it comes to maintenance of the fuel vent the manufacturer has provided the following information and maintenance instructions.

You will know the vent needs maintenance if vapor rushes into or out of fuel tank when you open deck fill cap. You may also notice difficulty while fueling (back-splash or pump shutting off continuously during fill).

Debris and spider webs can block the vent, especially after storage. Use these steps to clean vent screen before and after storage, or at least once a year.

This maintenance should be done while the boat is out of the water. This way you do not risk losing parts.

1. Use a 3/16” (5mm) hex wrench to turn cap off counter-clockwise. Set cap aside for re-installation
2. When cleaning, DO NOT allow debris to fall down the vent tube into tank.
3. Remove screen and clean with solvent or air pressure. **Be sure not to puncture the screen.**

4. Replace screen in original position. 5. Replace and tighten vent cap (30-to-35 in./lb. torque, 3.39 to 3.95N.Meters). **Do not over-tighten.**

F. Fuel Fills - Export Models

For export models, the fuel deck fills are located either on the aft deck or side decks, and are clearly marked with a fuel symbol or are labeled "GAS". See Figure 18. To open, insert the deck plate key (if applicable) into the holes on the cap and rotate counterclockwise. On other models simply rotate the gas cap counterclockwise. A tether connects the cap to body to help prevent loss overboard. Be sure to utilize the proper type and grade of fuel as recommended by the engine manufacturer. See Section I-2 for additional information.



Figure 18: Fuel Deck Fill - Export Models

The fuel fill fitting allows for venting below the fill cap. While the tank is being filled, the air displaced by the fuel escapes through the fuel fill/vent. The fuel fill, along with the tank venting, includes flame arrester and anti-surge features. These features provide added safety. Always open the cap slowly to allow air to escape.

The gasket seal on the fuel fill cap assists in sealing when closed. A missing or damaged gasket can allow water on the surrounding surfaces to run into the tank. Periodically inspect the gasket (if applicable) and/or the fuel deck cap for damage.

WARNING

DO NOT confuse "GAS" deck fill plate with "WATER" or "WASTE" deck plates. Deck fill plates are labeled according to the intended use.

WARNING

Spilled fuel is a fire hazard. DO NOT overfill or overflow the tank, or allow fuel spills into the hull or bilge. If spillage occurs, clean up immediately and dispose of soiled rags/towels in a proper container.

NOTICE

When fueling at a marina, DO NOT overfill. Fuel may spill into the water.

WARNING

*Avoid overboard spills. When tank is almost full the sound from the fuel fill/vent will change. The pitch will become higher indicating the tank is close to being full. Stop pumping fuel into tank. **DO NOT TOP OFF.***

After fueling, replace the fill cap, and wash the areas around the fuel fill plate. Residual fuel left on the deck and hull sides can be dangerous and will yellow the fiberglass. It will also damage the tape stripes and logos. Care should be taken, when cleaning, to prevent contaminating the fuel deck fill/vent. Cleaning with only mild soapy water is recommended.

G. Anti-Syphon Valve

The fuel withdrawal line is equipped with an anti-syphon valve where the line attaches to the fuel tank. This valve prevents gasoline from syphoning out of the fuel tank should a line rupture. See Figure 19 for anti-syphon location.

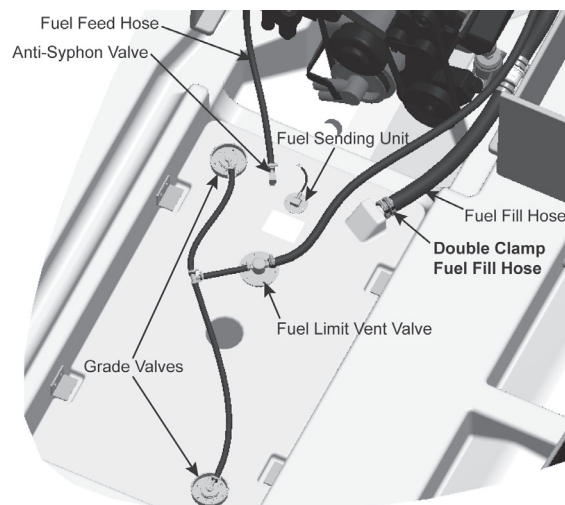

Figure 19: Fuel Tank Fittings
(Domestic Model Shown - Models May Vary)

CAUTION

The fuel withdrawals are positioned in the fuel tanks to achieve optimum fuel usage, and fuel line routing. At certain speeds and hull trim angles, the fuel supply at the withdrawal tank location can increase or decrease accordingly. Be extremely careful when attempting to operate the boat on a minimum amount of fuel. Though some fuel may be in the tank, the relative trim angle of the boat may cause the fuel to flow away from the withdrawal.

NOTICE

Access plates or lids are provided in the floor for easier access to the fuel pick-up, anti-syphon valve and sender.

H. Fuel Gauge

The fuel gauge indicates the amount of fuel in the tank. See Section E-7F - Fuel Gauge for additional information on fuel gauge use.

I. Fuel Sender

The fuel sender consists of a float which travels up and down a stationary tube. The float measures the level of the fuel in the tank and sends a signal to the fuel gauge. See Figure I10.

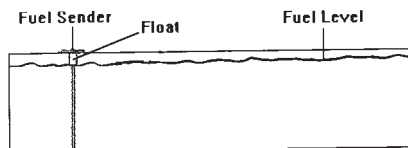

Figure I10: Fuel Sender Operation

Due to the mechanical nature of the fuel sender, variations in readings during various speeds of operation may occur. This system is merely a relative indication of the available fuel supply and not a calibrated instrument. With this type of sending unit a more accurate measurement of fuel level is obtained with the boat in a level position.

The gauge readings will also vary with the trim angle of the boat. When sitting at a dock and the boat is nearly level, the fuel gauge will register accurately. Refer to Figure I10. When boating, the trim angle of the boat changes and affects the gauge readings. Under these conditions, the fuel sender will register

“full” for the first few hours of running time until the fuel level drops below the 3/4 or 1/2 mark. This is caused by the angle of the fuel in the tank as shown in Figure I11.

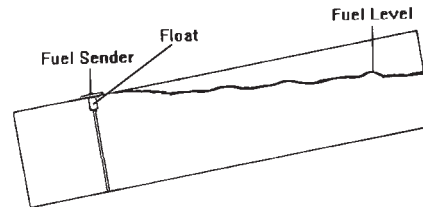

Figure I11: Effects of Trim Angle

It is very important to keep track of hours and fuel consumption to obtain an average gallon per hour consumption figure. Refer to the fuel log located at the back of this manual. This will help to prevent any problems with running out of fuel on the water.

Dealers are equipped with some general figures on consumption which can be used as a guide until specific information on your boat is determined. Because of boating conditions, speed, weight and other factors common to your situation, fuel consumption will vary between your boat and consumption figures developed by Four Winns.

When the fuel gauge begins to register below the “Full” mark, the gauge readings will drop much faster until it reads “empty”. When this occurs, the trim angle has affected the sender reading. When the gauge registers “empty”, the sender has bottomed out and there may be 3 to 4 gallons of fuel in the tank. See Figure I12.

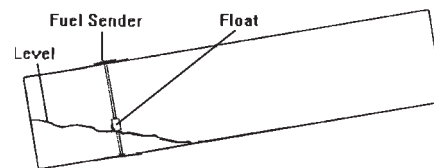

Figure I12: Trim Angle Effect with Low Fuel

J. Fuel Filters

Fuel filters are installed on each engine. Filters should be changed frequently to assure an adequate supply of fuel to the engine. Refer to the engine manual for additional information. The engine manual is included in the owner’s information packet.

NOTICE

Canister-type filters should be changed annually.

K. Use and Maintenance

 **WARNING**

DO NOT let the odor of gasoline go unchecked. If the odor of gasoline is noted, DO NOT START ENGINE. If engine is running, SHUT OFF ENGINE, ELECTRICAL AND HEAT GENERATING EQUIPMENT. Investigate and correct the situation immediately! Have all passengers put on personal flotation devices and keep fire extinguishers at hand until the situation is resolved.

 **WARNING**

Avoid serious injury or death from fire or explosion resulting from leaking fuel. Inspect systems for leaks at least once a year.

 **WARNING**

To help guard against damage, avoid the storage or handling of gear near the fuel lines, fittings and tanks.

I - 2 FUEL STANDARDS

Be cautious when using gasoline that contains alcohol. The fuel system components on the plastic fuel tanks used by Four Winns® will withstand up to 10% alcohol content in the gasoline. Also refer to the section on gasoline requirements in your engine manual for additional information.

 **CAUTION**

To conform to Federal Air Quality Standards, the petroleum industry reduced the amount of tetraethyl lead in gasoline. Alcohol is being blended with gasoline to help restore the octane rating lost when the lead was removed. While blending alcohol with gasoline increases the octane level of the fuel, it can also create certain safety and performance related problems for boaters.

A. Problems with Alcohol in Gasoline

Below is a list of problems which may be experienced when using blended gasoline.

1. Premature deterioration of fuel system components

may occur. Alcohol will attack rubber fuel hoses, fuel tanks, fuel filters, fuel pumps and rubber gaskets. This deterioration will lead to fuel system leakage.

2. Phase separation of fuel will cause contamination. Water which accumulates in the tank through contamination or condensation will be absorbed by the alcohol. This water-heavy alcohol will settle at the bottom of the tank. This phase separation will lead to fuel tank corrosion. This may also result in a lean mixture to the carburetor and cause engine stalling or possible engine damage.

The use of alcohol additives in gasoline has become more widespread. Regulations on public notification of the existence of additives is currently controlled by the Environmental Protection Agency (EPA). Some states do require that gasoline pumps display information on additives (especially alcohol). If alcohol content is not posted, ask and avoid using fuel containing alcohol if possible.

B. Recommendations

Assume blended gasoline is being used and follow these recommendations below.

1. Inspect fuel hoses often. A deteriorated hose containing alcohol blended gasoline will normally be soft and swollen. A deteriorating hose containing no fuel will normally be hard and brittle. In both cases the hose should be replaced.
2. Ventilate the engine compartment before starting the engine. Operate the engine compartment blower for four (4) minutes. Then, prior to starting the engine, check the bilge area for the scent of gasoline fumes; DO NOT start the engine if the odor of gasoline is detected.
3. Frequently inspect the fuel system fittings. Inspect the fuel tank, pump and filter for signs of leaks or corrosion. Visually inspect for deteriorating metal fittings at the fuel hose connections.

 **WARNING**

Avoid serious injury or death from fire or explosion resulting from leaking fuel. Inspect system for leaks at least once a year.

If areas are found within the fuel system that appear questionable, have a qualified marine technician inspect the system. A thorough fuel system examination

should be made by an experienced marine technician at least once a year.

I - 3 FUELING INSTRUCTIONS

1. Avoid fueling at night except in emergencies.
2. When moored at fueling pier:
 - a. Do not smoke, strike matches, or throw switches.
 - b. Stop all engines, motors, fans, and devices that could produce sparks.
 - c. Put out all lights.
3. Before starting to fuel:
 - a. Ensure that boat is moored securely.
 - b. Be sure the proper type and grade of fuel as recommended by your Engine Owners Manual is used.
 - c. Know the capacity of your fuel tank and how much fuel is currently in the tank before fueling. Determine how much additional fuel is required to avoid overflow.
4. During fueling: Keep the fill nozzle in contact with the fuel opening at all times to guard against possible static spark. See Figure I13.



Domestic Models

*Avoid overboard spills. Be alert. The fuel nozzle should automatically shut off when using an automatic shut off nozzle. Be ready in the event it does not or if you are using a different type of nozzle for dispensing fuel. **DO NOT TOP OFF.***



Export Models

*Avoid overboard spills. When tank is almost full the sound from the fuel fill/vent will change. The pitch will become higher indicating the tank is close to being full. Stop pumping fuel into tank. **DO NOT TOP OFF.***

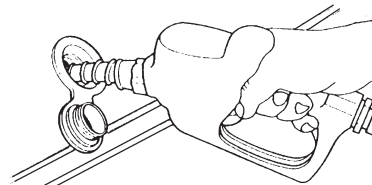

Grounding the fuel hose - Proper

**(Nozzle in contact with fuel opening.
Grounding the fuel hose - proper)**

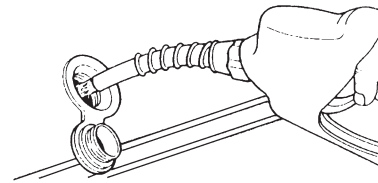

Not grounding the fuel hose - Improper

**(Nozzle not in contact with fuel opening.
Not grounding the fuel hose - Improper)**

Figure I13: Grounding Fuel Hose

5. After fueling:
 - a. Replace all fill cap(s) securely.
 - b. Wipe up any spilled fuel.
 - c. Determine that there is no odor of gasoline in the engine compartment or below decks before starting machinery, turning on lights or lighting stove (if applicable). Operate the bilge blower system for at least four (4) minutes before engine start-up.
 - d. Be prepared to cast off moorings as soon as engine is started.



J - 1 GENERAL

Some F series models are equipped with a fresh water supply system. This system typically consists of a water supply tank, water distribution lines, forward and aft shower, sink with faucet and a distribution pump. Refer to Figure J18 at the end of this section for general water system diagram.

The water fill deck plate is located either on the aft deck or side decks, and is marked "WATER". The location of the water fill deck plate for the fresh water system may vary depending upon the model and optional equipment installed. See Figure J1.



Figure J1: Water Fill & Vent

CAUTION

The water deck plate is appropriately labeled WATER. DO NOT fill the system with anything other than water. Should the system become contaminated with fuel or other toxic solution, complete system or component replacement may be necessary.

The fresh water tank which supplies water to the forward & transom shower and sink is located inside the engine compartment on the port side. (Location may vary depending upon model and options installed). See Figure J2.

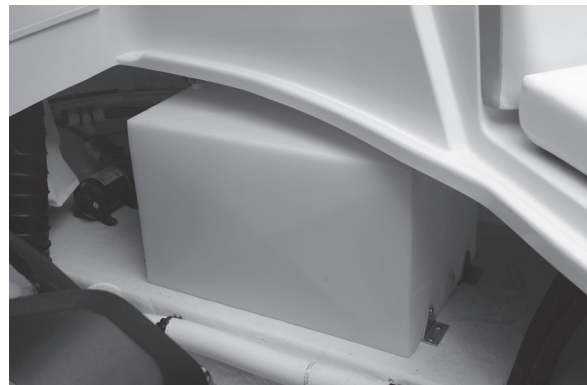

Figure J2: Fresh Water Tank Location
(Representative View - Models May Vary)

The water tank is equipped with an overboard vent. Maintain a close visual watch on the overboard vent while filling the water tank. Always fill the tank slowly. When the tank is almost full, water will spurt out of the vent. See Figure J1.

NOTICE

When filling the tank, never seal the hose to the deck plate. The tank would become pressurized and could rupture.

NOTICE

DO NOT overfill the water tank. Tank damage may result. Water capacity and tank location may vary due to other equipment that may be installed on the boat.

For information concerning fresh water tank capacities, please visit our website at www.fourwinns.com or contact your Four Winns dealer.

The materials from which the components of the water system are made may give the water supply a peculiar taste, especially when new. This condition is normal and can be reduced somewhat through the use of a water filter; such as that produced by PuriTeam. The taste should completely dissipate in time.

J - 2 DISINFECTING THE FRESH WATER SYSTEM

CAUTION

The fresh (potable) water system should be disinfected prior to initial use.

The water system should be disinfected before first use and at the beginning of each season. The following information is a general guide to disinfecting the fresh water system.

1. Flush the boat's water system thoroughly with fresh water. Make sure all non-toxic antifreeze is removed from the system.
2. The water system should be drained completely.
3. To disinfect the water system, use one gallon of water and 1/4 cup of household bleach (5% sodium hypochlorite solution). This is recommended for each 15 gallons of tank capacity.
4. Allow to stand for three (3) hours. If time is a factor, greater concentrations of chlorine solution will be needed to disinfect the water system.
5. Drain the system.
6. Flush the system thoroughly with fresh water.
7. Fill the system with fresh water.

To remove excessive chlorine taste or odor which might remain in the system, prepare a solution of one quart vinegar to five gallons water and allow this solution to agitate in the tank for several days during boating. Then drain tank and refill with fresh water.

Note: The cockpit sinks are equipped with traps, and the water will drain slowly. If the system is not operating properly, have it checked by your authorized Four Winns dealer.

J - 3 FRESH WATER SYSTEMS

A. Integrated Sinks

Certain F series models have an integrated sink and trash receptacle located in the bow area. See Figure J3. Other models have a refreshment center at the bow and a trash receptacle integrated in the port cockpit console. See Figures J4 & J5.



Figure J3: Sink and Trash Receptacle - Bow



Figure J4: Refreshment Center - Bow



Figure J5: Trash Receptacle - Port Console

The fresh water switch is typically located on the battery switch panel. See Figure J6. After the tank has been filled, activate the "FRESH WATER" switch until water comes out of the shower or faucet (if applicable). After all the air has been purged from the system and a steady flow of water is coming from the shower(s) or faucet. Turn off the shower or faucet. The excess water from the sink will drain overboard.



Figure J6: Fresh Water Switch on Battery Switch Panel

When properly primed and activated, the pressurized water system can be used in the same manner as the water system in a home. An automatic pressure sensor in the water pump keeps the system pressurized. Simply operate the faucet or shower and water will be delivered with the “FRESH WATER” switch activated. Turn the “FRESH WATER” switch “OFF” when not on use.

NOTICE

If the line is routed improperly, kinked or is dislocated, the water pump may not operate properly. Inspect and correct the hose routing (if necessary). If a problem still exists, contact your Four Winns dealer for assistance.

NOTICE

DO NOT operate the pump with an empty tank. Damage to the water pump may result. Be sure the pump switch is off when not in use.

B. Forward and Aft Showers

A forward shower is available on certain F series models as is an aft shower. The fresh water supply system can be used for showering or washdown purposes. See Figures J7 & J8.



Figure J7: Forward Shower
(Representative View - Models May Vary)



Figure J8: Aft Shower
(Representative View - Models May Vary)

The fresh water tank which supplies water to the forward and aft showers is usually located in the rear engine compartment on the port side of the boat. (Models may vary depending on options installed). The fresh water deck plate used for filling the tank is usually located in the same general vicinity as the tank itself. The fresh water deck fills are clearly mark “WATER”. An in-line fuse is included to protect the water pump. The pump is located in the rear engine compartment usually near the vicinity of the fresh water tank.

Models equipped with the forward and aft shower will use the same fresh water pump used for the cockpit sink. With the “FRESH WATER” switch “ON”, push the spray nozzle button to purge any air that may be in the system. When a steady flow of water is coming from the washdown nozzle the air has been purged. Release the spray nozzle when finished. As the pressure builds, the pump will automatically shut off at 35 psi.

When properly primed and activated, the pressurized water system can be used in the same manner as the water system in a home. An automatic pressure sensor in the water pump keeps the system pressurized. Simply operate the spray nozzle and water will be delivered. If the system has been recently filled, or has not been used for an extended period of time, air bubbles may accumulate at the pump. If this should happen, re-priming may be necessary.

J - 4 WASTE SYSTEMS

A. Enclosed Heads

On certain F series models, a fully enclosed fiberglass head is available and is built into the port console. These roomy heads offer an opening port light with screen, porta-potti, fiberglass liner, and overhead lighting. See figure J9. A general guide on porta-potti use is included in this section. Note: Models may vary. Refer to the manufacturer's literature included in the owner's packet regarding the use, care and maintenance of the porta-potti if installed.



Figure J9: Enclosed Head

B. Porta-Potti

A porta-potti or porta-potti with pumpout is available on certain F series models. A general guide on porta-potti use is included in this section. Note: Models may vary. Refer to the manufacturer's literature included in the owner's packet regarding the use, care and maintenance of the porta-potti if installed.

Porta-Potti Preparation:

Separate unit by sliding the locking lever to the left "unlocked" position and hold (Figure J10A). Separate the units (Figure J10B).

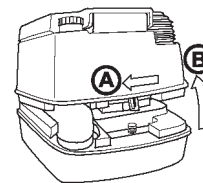

Figure J10 (A & B): Separate Porta-Potti

With the waste tank (lower section) sitting flat, open valve by pulling handle out (Figure J11A).

Add deodorant through the valve opening (Figure J11B). Use Thetford Holding Tank Deodorant (sample included) in built-in storage compartment (Figure J11C). Add water to cover tank bottom. Close valve and replace deodorant (Figure J11D).

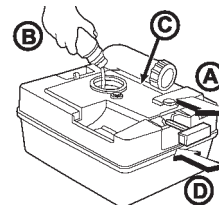

Figure J11 (A - D): Porta-Potti Preparation

Recombine the unit. Align hinge with front interlocking tabs. To secure unit, press downward – it should click into place.

Fill fresh water tank by removing the water fill cap and filling the tank with fresh water (Figure J12). **(NEVER add holding tank chemical to the fresh water tank assembly.)** Replace and tighten the cap securely.

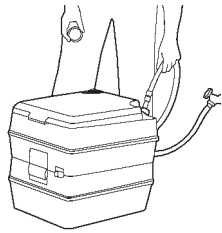

Figure J12: Filling Fresh Water Tank

NOTICE

Before each use: With seat cover closed, open and close the holding tank valve (Figure J9) to vent any pressure that may have built up as a result of heat or altitude. This prevents upward splashing of bowl contents when toilet is flushed.

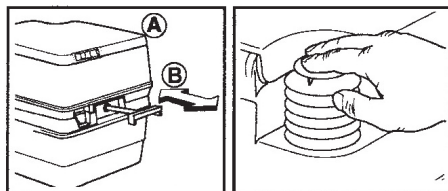

Figure J13 (A & B): Porta-Potti - Bellows Flush Operation

Bellows Flush Operation:

1. Pull out holding tank valve handle (Figure J13B).
2. Push down on bellows to rinse the bowl.
3. Push valve handle all the way in to insure an odor-tight seal.

Emptying of Portable Models:

1. Empty when waste holding tank level appears full. **DO NOT ALLOW THE TANK TO BECOME OVER-FILLED.**
2. Make sure waste valve handle is in the closed position.
3. Remove fresh water tank from waste holding tank (Figure J14).

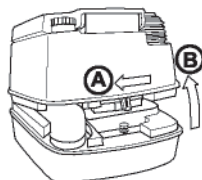

Figure J14 Removing Fresh Water Tank

4. Remove waste holding tank from hold down brackets.
5. Carry the waste holding tank to any permanent toilet facility. Rotate the pour-out spout to the desired position. Remove the cap. Depress the air relief valve with your thumb while emptying (Figure J15).



Figure J15: Emptying Waste Holding Tank

6. Rinse waste holding tank and recharge as described under preparation portion of this section.
7. Reassemble unit and fasten to floor or deck.

C. Porta-Potti w/Pumpout

If equipped, the waste holding tank should be emptied when waste holding tank level gauge indicator on the porta-potti (models with pumpout only) has changed from green to red (Figure J16). **DO NOT ALLOW THE TANK TO BECOME OVERFILLED.**



Figure J16: Porta-Potti

With the head pumpout, the waste can be removed from the tank at a pumping station. A deck plate fitting labeled WASTE, is provided for this purpose. See Figure J17. Most marina fueling facilities provide service for waste pump out. For waste holding capacities, please refer to the manufacturer's literature and/or our website.

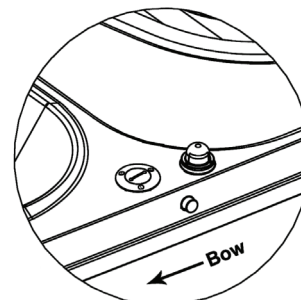

Figure J17: Pumpout Waste Deck Fitting

To pump out the holding tank:

1. Connect the dockside pump out connection to the WASTE plate located on the deck.

NOTICE

Usually the dockside pump out connection will screw into the waste deck plate or has a rubber sleeve that inserts into the plate and must be held in position during the pump out operation.

2. Have the pumping station operator activate the pumping equipment. The waste will be drawn from the holding tank and into the pumping stations disposal tank.
3. Remove the pump out connection from the deck plate. Add 1 gallon of clean water to the holding tank through the waste deck fitting using a dockside water hose.
4. Repeat steps 1 & 2 above to pump out the water used in step 3 to flush the holding tank.
5. Add waste holding tank treatment chemical available from the dockside pumping station operator to the head. Flush at least twice.

CAUTION

Be careful when handling and storing treatment chemicals. Not only are they toxic, but they will also stain and damage surrounding surface.

It will be necessary to remove the top holding tank of the portable head to fill with water. Refer to the manufacturer's literature included in the owner's packet regarding the use, care and maintenance of the porta potti.

J - 5 SYSTEM MAINTENANCE

Be sure the battery(s) in the boat are properly charged. Operating the pressure pump from a battery with a low charge will result in pump cycling. This could lead to premature pump failure.

WARNING

The decomposition of waste produces methane, a colorless, odorless gas that is lighter than air, combustible, and extremely lethal. Always provide sufficient ventilation when effecting repairs to the waste system and allow no odor from the waste system to go unresolved.

A. Clean Vents and Screens

Periodically, inspect the water tank vents and thru-hull vent fittings for any dirt, wax, etc. Carefully remove any obstruction with a pipe cleaner or similar device. **Be sure not to puncture any screens.** On models with a stainless steel vent cap, the cap may not be removable.

NOTICE

Failure to keep the water tank vent fitting clean will cause excessive pressure buildup within the tank during filling. This can cause water tank damage.

B. Winterizing the Water System

Winter lay-up service procedures should include a thorough draining of the water system. Disconnect all accessible fittings. Blow out all lines. Be sure the water tank, waste tank, pumps and lines are completely dry. Freezing water can cause severe damage to all water system components.

NOTICE

It may be necessary to disconnect the hose below the faucet to remove excess water in the lines to prevent freeze damage.

NOTICE

Always winterize the fresh water system prior to winterization of the hull drainage (bilge pump) system.

Draining the system as mentioned can be very tedious and an incomplete job can result in expensive repairs. The use of nontoxic antifreeze (such as RV anti-freeze) designed for fresh water systems considerably reduces the work necessary and is a more positive means of winterizing the system. Follow the directions included with the antifreeze solution.

To winterize:

1. Turn on the water pump/faucet and drain the water tank. The water tanks on some models can be drained by removing the withdrawal hose from the tank and allowing water to drain into the bilge.

NOTICE

DO NOT run the water pump without water in the system. Pump damage can result. Be watchful and turn the pump off as soon as the tank becomes empty.

2. Add 1/2 gallon of RV non-toxic antifreeze to the water tank.
3. Turn ON the pump until undiluted antifreeze is seen.



Use only nontoxic antifreeze solutions such as RV antifreeze. DO NOT use ethylene glycol solutions (the type that is used in engine coolant systems). These are toxic.

NOTICE

Be sure to wipe up any antifreeze that has been spilled on the fiberglass surfaces to prevent possible discoloration or damage to the gel coat.

Depending upon options and model, additional information by the equipment manufacturers is included in the owner's packet. Also, refer to Section R for Maintenance.

WATER SYSTEM

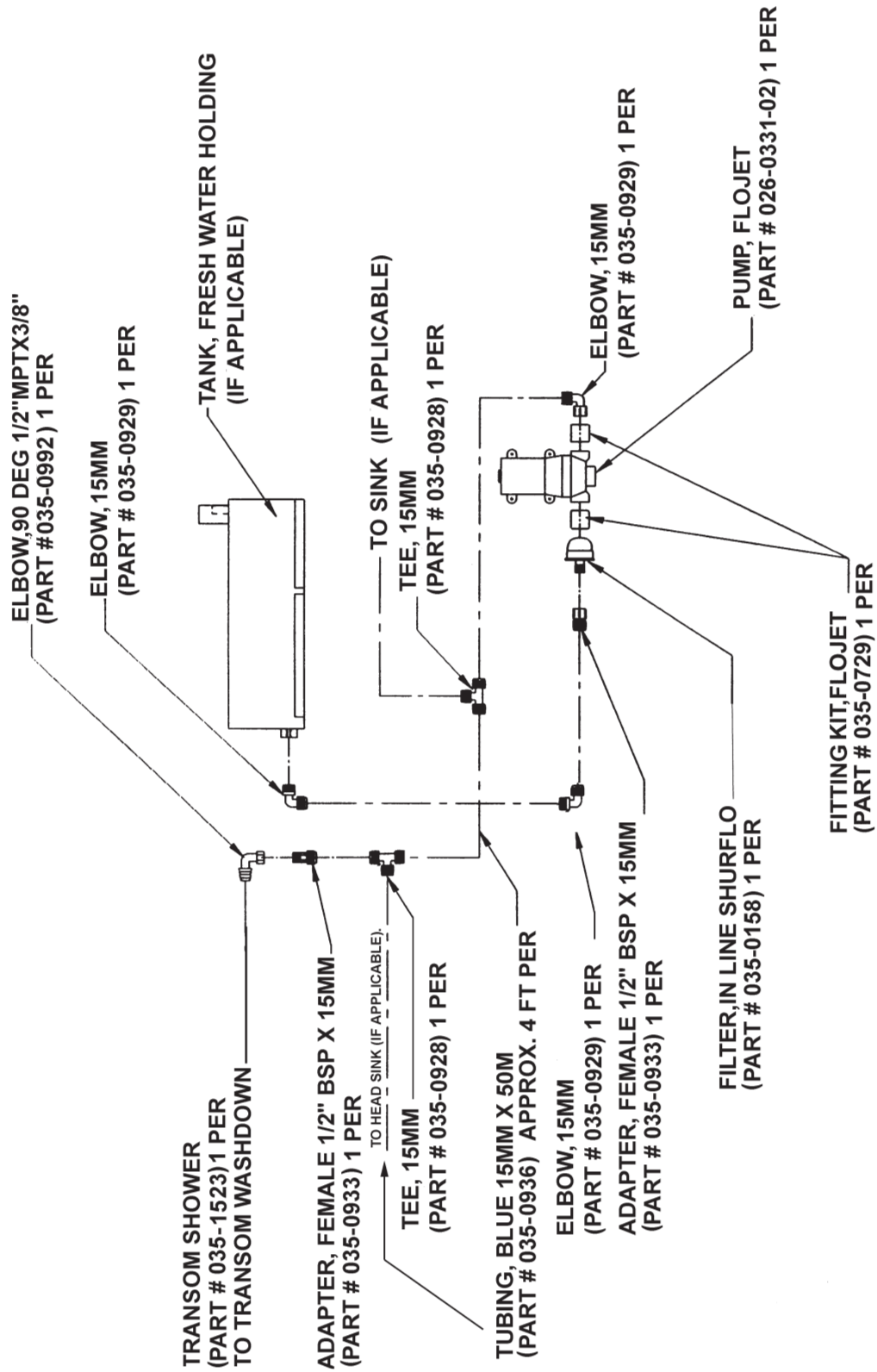

Figure J18: General Water System Diagram
(Representative View - Models May Vary)

K - 1 ENGINE COMPARTMENT VENTILATION

All Four Winns® stern drive models are equipped with engine compartment ventilation. This system is designed to meet or exceed the requirements (in effect at the time of manufacture) of the U.S. Coast Guard, the National Marine Manufacturers Association, and the American Boat and Yacht Council.

A. Natural Ventilation System

This system includes air intake and exhaust components. The air and exhaust ducts reach to the lower bilge area. This provides adequate air movement while underway and during bilge blower operation.

B. Forced Air Ventilation

All Four Winns® models are equipped with an electric bilge blower. The bilge blower provides the ventilation required prior to starting the engines and while at idle. See Section H - Electrical Systems for blower operation instructions.

 **WARNING**

Gasoline vapors can explode resulting in injury or death. Before starting the engine, check the engine compartment bilge for gasoline or vapors, and operate blower for four (4) minutes, and verify blower operation. Run blower when vessel is operating below cruising speed. ALWAYS operate the bilge blower while the engines are at idle.

C. Engine Ventilation System Maintenance

Periodic inspection and cleaning of the ventilation ducts is necessary to ensure adequate air circulation. A buildup of leaves, twigs, or other debris can severely reduce ventilation. Be sure bilge water does not accumulate to a level that would obstruct the ventilation ducts.

Blower operation can be tested by placing a hand over the vents. DO NOT rely on the sound of the blower. Be sure a substantial amount of air is being exhausted by the bilge blower. Check the bilge blower system often, preferably before each cruise.

Should blower noise and vibration be excessive, loosening the bilge blower mounting screws and then tightening evenly usually reduces noise considerably.

K - 2 HULL DRAINAGE SYSTEMS

A. Transom Drain

A transom drain with plug is provided in the engine compartment to allow water drainage. When the boat is out of the water, the boat and trailer should be positioned so any bilge water accumulation during dry storage will flow towards the transom.

 **CAUTION**

Be sure the drain plug is securely in place prior to launching the boat. Upon shipment of the boat, the drain plug is usually taped to the steering wheel.

B. Bilge Pump

A bilge pump is provided in the bottom of the hull to remove miscellaneous water accumulations that might occur during normal boating or weather conditions. The bilge pump is controlled by the bilge pump switch on the dash panel. See Section H-4 for a detailed description of the bilge pump switch.

The bilge pump is typically equipped with an automatic switch. As the water level rises, the automatic float switch will activate the pump. When leaving the boat unattended for long periods of time or during excessive rain storms, it is a good idea to check on the boat for excessive water accumulation. Be sure both the bilge pump and automatic float switch are operating properly. The operating time of the bilge pump will be limited to the battery capacity.

NOTICE

While at rest, any bilge water accumulation may flow forward. Therefore, operate the bilge pump shortly after getting underway and while the boat is at a substantial running angle. DO NOT allow bilge water to accumulate. Damage to the engine or other components may result.

Periodically, clean the bilge pump strainers. DO NOT allow dirt and debris to clog the bilge pump intakes. Check operation of the bilge pump float switch often to ensure movement of the switch is not restricted by debris, portions of the hull, etc.

Wipe up any oil accumulation in the bilge prior to activation of the bilge pump. Pumping oil overboard will pollute the water, and is subject to fine.

After winterization of the fresh water system (if applicable), be sure the bilge area, bilge pump and associated hoses are thoroughly dry. Damage to the hull, bilge pump and other equipment could occur if water is allowed to freeze in the bilge.

C. Liner Drains

Fiberglass liners with liner drains are standard on most models. Fiberglass liners can be cleaned easily with water and a brush. See Figure K1. The water will drain into the bilge and be pumped overboard by the bilge pump.



Figure K1: Fiberglass Liner

D. Bilge Compartment Drainage

Certain bulkhead areas of Four Winns® boats are sealed in accordance with U.S. Coast Guard regulations effective at the date of manufacture. Drainage is provided and water can be removed with the bilge pump.



L - 1 INTEGRATED SINK

Some F series models have an integrated sink and trash receptacle located in the bow area or port console. The excess water from the sink will drain overboard. On certain models the lid for the trash receptacle consists of a solid surface material and includes a finger-pull to allow easy access. See Figure L1 & L2.



Trash Receptacle Lid

Sink & Faucet

Figure L1: Integrated Sink & Trash Receptacle

L - 2 INTEGRATED SINK & COOLER

Other models have an integrated sink, trash receptacle and cooler located in the bow area. The excess water from the sink and cooler will drain overboard. The cooler lid and countertop consists of a solid surface material and includes a finger-pull in the cooler lid to allow easy access. See Figure L2.



Figure L2: Integrated Sink, Cooler & Trash Receptacle

L - 3 BUILT-IN ICE CHESTS

Most F series models have a built-in ice chest located in the bow, underneath the center bow cushion. Along with the integrated ice chest, a 36-quart removable cooler is included. The cooler can be stored beneath the port hinged seat for the F series models. Certain models may also have another built in ice chest/stor-

age compartment located between the two bucket seats or at the transom walk-thru. See Figures L3 and L4.

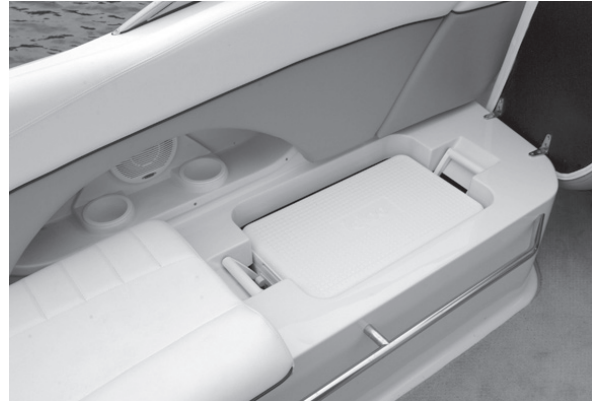

Figure L3: Removable Cooler and Storage



Figure L4: Ice Chest Transom Walk-thru

L - 4 HEADS

On certain F series models, an enclosed head is built into the port console. These roomy heads offer overhead lighting, opening port light with screen, and porta-potti. See Figure L5.



Figure L5: F series Enclosed Head

L - 5 STEREO

Four Winns offers a AM/FM/CD stereo as standard equipment on the F series models. The AM/FM/CD stereo is typically mounted on the helm console. See Figure L6. An available stereo remote may be installed at the swim platform on certain models. Please consult with your Four Winns dealer regarding availability.



Figure L6: Stereo - Helm

For stereo operation, please refer to the manufacturer's manual included in the owner's information packet.

The speakers are installed within the side bulkheads or seat bases depending on the model. For additional information on stereos, refer to Section H-5C of this manual and the manufacturer's literature included in the owner's packet.

L - 6 ANCHOR/LADDER STORAGE

F series models have a built-in anchor/ladder locker. It is located at the bow of the boat. Simply lift the anchor lid to gain access to the anchor/ladder locker. The ladder located inside is a 3-step telescoping ladder which provides entry from the land/water at the bow. The anchor/ladder lid provides a hand hold that make boarding easier. See Figure L7.

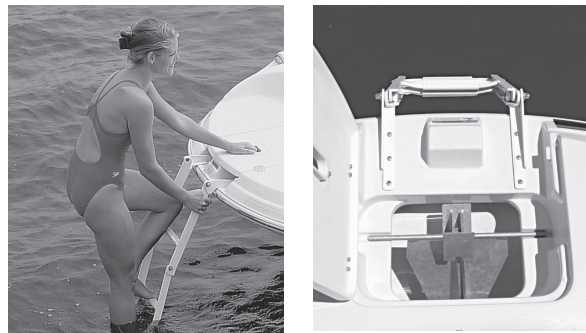

**Figure L7: Bow Ladder
Anchor Locker with Hidden Ladder**

L - 7 IN-FLOOR SKI LOCKER

A feature on most F series is an in-floor ski locker. The locker allows for storage of skis, tow ropes, personal flotation devices, etc. The storage lid is hinged and includes a gas assist shock for ease of use. The lid is designed to stay in place in choppy water. See Figure L8.



Figure L8: In-Floor Ski Locker

L - 8 BOW STORAGE

The port and starboard bow seat cushions are removable on all F series models. Underneath each cushion is additional storage for all types of gear. See Figure L9.

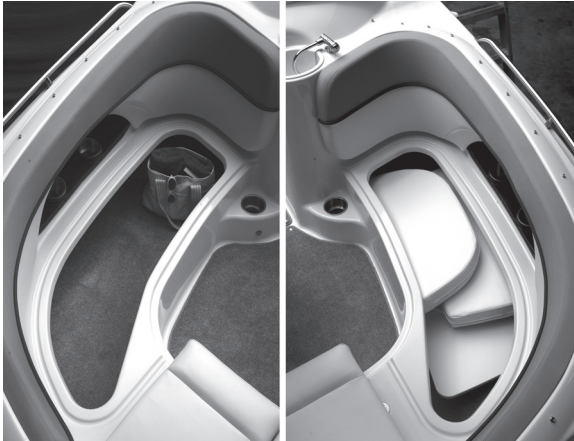

Figure L9: Bow Storage

L - 9 BOW FILL-IN CUSHIONS

Utilizing the available bow fill-in cushions you can turn the bow of your F series into a sundeck. These bow fill-in cushions can be easily removed or installed in a matter of minutes. The bow cushions may be stored in the starboard helm storage locker or in bow storage. See Figure L10



Figure L10: Bow Fill-In Cushions

L - 10 STERN SEAT STORAGE

Additional storage space is provided under the stern seating area. This allows you to store necessary equipment without taking up usable space. See Figure L11.



Figure L11: Stern Seat Storage

L - 11 STARBOARD CONSOLE STORAGE LOCKER

Certain F series models feature a starboard console storage locker. The storage locker provides the storage space needed for all the essentials one needs to make an all day boating adventure a success. See Figure L12.



Figure L12: Starboard Console Storage

L - 12 WALK-THRU DOOR

A walk-thru door is available on certain F series models. The walk-thru door is designed to keep out the wind and weather, making for a warmer cockpit area. See Figure L13.



Figure L13: Walk-Thru Doors

L - 13 COCKPIT TABLE

A table with mount is available for the F series models. See Figures L14 & L15. If equipped, the cockpit table provides a solid surface to enjoy refreshments or games. The table leg is angled and attaches to the seat base using the mount. This type of mounting provides for more leg room. Rotating the table top while lifting will ease the removal of the table from the leg. The angled table leg slides out from the mount for storage.



Figure L14: Aft Cockpit Table
(Representative View - Models May Vary)

See Section Q - 4 - Laminated Fiberglass for care instructions.

NOTICE

Four Winns continually strives to improve its products. Unit specifications, including standard and optional equipment are constantly being modified. Equipment availability is also subject to change without notice. The most current and accurate information available at the time of publication is included in this manual. Some variation in equipment, description, location, and details can result. Please refer to the manufacturer's literature in the owner's packet.



M - 1 RAILS & DECK HARDWARE
A. Rails

The rail system and hardware fittings have been selected and installed to perform specific functions. See Figure M1. Fenders or mooring lines should not be secured to the rails or stanchions. Be certain that a clear lead exists when running dock lines or an anchor line. A line inadvertently threaded around a stanchion or over a rail could cause damage.



Figure M1: Bow Rail
(Representative View - Models May Vary)

Assist handles or rails have been installed to provide security for passengers in the cockpit. See Figure M2. Limiting passenger movement while underway is recommended. All those on board should be safely seated whenever possible. Additional care must be taken when in rough seas or foul weather.



Figure M2: Passenger Assist Handle
(Representative View - Models May Vary)

B. Cleats

The cleats that have been installed are specifically designed and are intended to be used as mooring cleats. Their purpose is for securing the vessel to a dock, pier, mooring, or anchor.

A pull-up style cleat is available on certain F series models. If equipped, the pull-up cleat gives your boat a more sleek style. When you desire to use the cleat, simply pull up on the cleat. When finished with the cleat, push in and the cleat will remain in its retracted position until the next time you desire to use it. See Figures M3 and M4.



Figure M3: Pull-Up Cleat - Extended



Figure M4: Pull-Up Cleat - Retracted

WARNING

Four Winns® Boats are not equipped with any hardware designed for towing other craft. The mooring cleats that are installed on the boat are not to be used for towing another vessel or having the boat towed. Refer to the section on Operation - Section A for additional precautions regarding grounding and towing.

C. Transom Ski Tow

The stainless steel transom ski tow is mounted on the transom above the swim platform on the F series models. Four Winns recommends no more than two skiers be pulled behind the boat at any time. See Figure M5.



Figure M5: Transom Ski Tow

⚠ WARNING

Do not use ski tow fitting or arch (if applicable) for lifting or parasailing. Fittings could pull out of deck resulting in serious injury or death.

⚠ WARNING

To prevent personal injury or damage to the boat, DO NOT tow more than two water skiers with the transom mounted ski tow ring.

NOTICE

Skier's weight, boating conditions, amount of gear, and operator's experience will affect the number of skiers which can be pulled.

D. Bow Scuff Plate

Available on certain F series models is a stainless steel bow scuff plate. The bow scuff plate (if equipped) is designed to provide added protection for the bow in addition to a stylish look. See Figure M6. Please see your Four Winns Dealer for further information.

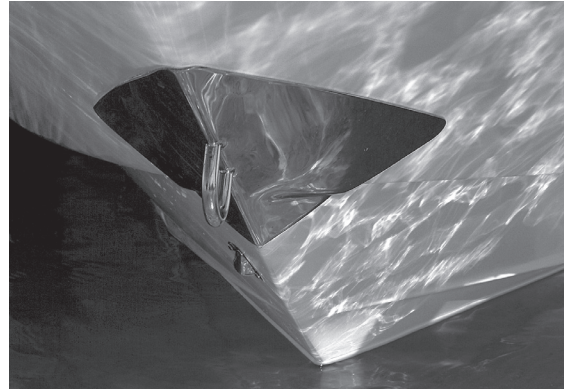

Figure M6: Bow Scuff Plate

E. Maintenance

The majority of the hardware installed is made of stainless steel. Regardless of the type of hardware used, periodic maintenance is necessary.

The manufacturer of our hardware recommends the following when washing your boat:

1. Rinse the hardware with fresh water after each exposure to saltwater.
2. Periodically wash the hardware with mild soap, warm water, and a sponge. Then dry it with a soft cloth.
3. Avoid cleaners, abrasives, waxes, and most of all, do not use steel wool.

NOTICE

All fittings must be periodically inspected for loosening, wear, and damage. Problems should be corrected immediately!

M - 2 WINDSHIELDS

The windshield on all F series models is standard equipment. See Figure M7. The windshield consists of tempered safety glass and the windshield frame may consist of either a painted, powder coated or anodized aluminum (depending on the model). For easy accessibility to and from the bow, a walk-thru center windshield is standard. Stainless steel supports or braces are used in most of the windshield assemblies.

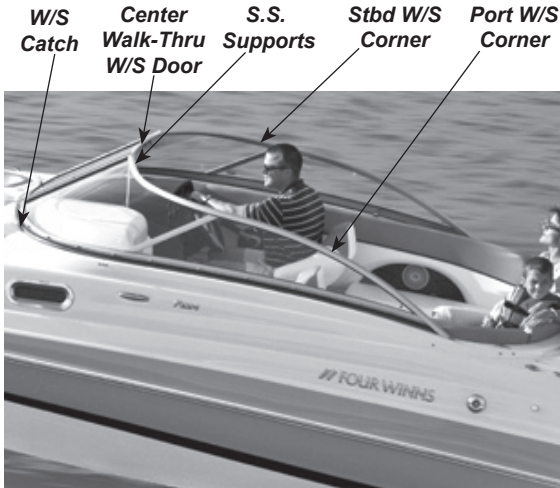

Figure M7: Windshield

⚠ CAUTION

We recommend you close and secure the walk-thru windshield while underway. Damage to the windshield could result otherwise.

⚠ CAUTION

Secure windshield with magnetic catch (if applicable) when in open position. See Figure M8. Securing the walk-thru windshield will help prevent the windshield from accidentally slamming closed due to high wind and/or wake condition, thus reducing the chance of damage to windshield or injury.



Figure M8: Magnetic Catch for Center Walk-thru

Windshields made of tempered glass can be cleaned with automotive glass cleaners or dishwashing soap and water. Use a clean cloth to prevent scratching the glass.

Aluminum can be cleaned with similar products or with nonabrasive cleaners such as Fantastic.

NOTICE

Read the label before using any product. DO NOT use abrasive cleaners.

M - 3 ANCHOR/LADDER LOCKER

The F series models have a built-in anchor/ladder locker. It is located at the bow of the boat. Simply lift the anchor/ladder lid to gain access to the anchor locker. The compartment should be inspected after each use, and kept clean of dirt and debris to prevent plugging of the drain hole.

M - 4 AFT SWIM PLATFORM AND LADDER

Four Winns provides an integrated fiberglass swim platform at the bow and an aft swim platform at the stern. For better footing, a skid resistant surface is provided. The aft swim platform is recessed for the ladder and a hinging ladder is provided. With this design, the ladder is concealed by the ladder lid and you do not lose valuable platform space. See Figure M9.

The stern ladder is “deep” and “angle-mounted” and includes wide step pads which make it easier to climb. In addition, a hand hold has been placed in the ladder lid to assist in boarding. The stern ladder’s starboard location means you’re not approaching a downed skier on your “blind side”.



Figure M9: Extended Swim Platform (Representative View - Models May Vary)

⚠ WARNING

Keep hands and fingers away from ladder hinges to prevent injury.

⚠ WARNING

Never approach or use ladder when the motor is running. Severe injury or death will result from contact with rotating propeller.

⚠ WARNING

Shut off motor when near swimmers. Severe injury or death will result from contact with rotating propeller.

⚠ WARNING

To prevent personal injury, swim platform and transom entry area must not be occupied while engine is running and/or boat is underway.

NOTICE

Always secure the ladder before boating. Damage to the ladder may otherwise result.

⚠ WARNING

To prevent personal injury, swim platform must not be occupied and transom walk-thru backrest door must be in place while engines are running.

⚠ CAUTION

To prevent personal injury, DO NOT sit on the transom walk-thru backrest door.

NOTICE

Cushions, if not properly stored and secured, can blow out of the boat or become damaged.

M - 5 TRANSOM WALK-THRU BACKREST DOOR

A transom walk-thru backrest door is removable to allow easy access from the swim platform to the cockpit. To secure the backrest walk-thru door to the transom, simply slide it between the two sets of cleats. To prevent a possible man overboard situation, make sure the transom walk-thru backrest door is in place before each cruise. See Figure M10.

⚠ WARNING

Prevent falls overboard. Secure transom walk-thru backrest and stay inside cockpit while underway.



Figure M10: Transom Walk-Thru Backrest Door
(Representative View - Models May Vary)

M - 6 DOCKING LIGHTS

Docking lights are available on certain F series models. If equipped with these lights, docking your boat becomes easier during periods of reduced visibility. The docking lights may be activated at the helm using the designated switch. See Figure M11.



Figure M11: Docking Lights
(Representative View - Models May Vary)

M - 7 WAKEBOARD TOWER & SST ARCH

Certain F series models have a wakeboard tower and/or stainless steel arch available. See Figures M12 & M13. If equipped, these towers or arches come with a variety of features which will sure to please the wakeboard enthusiasts. Please see your Four Winns Dealer for information regarding these features. If equipped, follow the manufacturer's instructions for use and maintenance. Refer to Section B-4 Water Sports of this manual for safety guidelines.



Figure M12: Wakeboard Tower
(Representative View - Models May Vary)

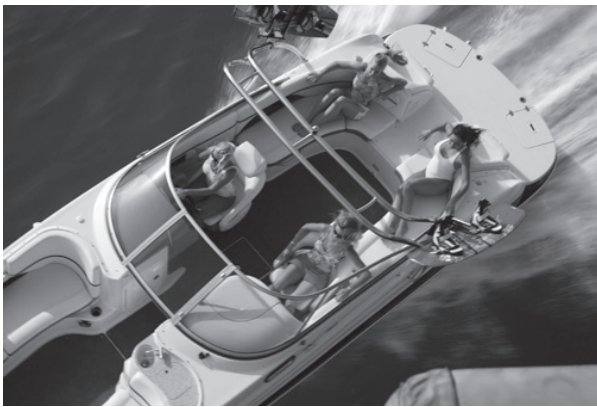

Figure M13: Stainless Steel Arch
(Representative View - Models May Vary)

⚠ WARNING

Do not use ski tow fitting, wakeboard tower or arch for lifting or parasailing. Fittings could pull out of deck resulting in serious injury or death.

⚠ WARNING

Misuse of tower/arch can over stress tower/arch or dangerously imbalance boat. Failure to follow these guidelines can result in injury or death. This tow tower/arch is to be used for towing wakeboard and ski devices only. Do not tow more than two persons at a time from this tower/arch. Do not use tower/arch for lifting, parasailing or towing other watercraft. Do not allow passengers to sit behind rope attachment point when tower/arch is in use. Do not allow loose tow rope ends to dangle. Do not climb on, hang on, sit on, jump or dive off this tower/arch. Check all tower/arch fasteners for tightness before using tower/arch.

M - 8 WAKEBOARD TOWER & SST ARCH CARE

If equipped, wakeboard towers and stainless steel arches require the following annual maintenance:

1. Visually inspect all welds for cracks.
2. All welds should be touched up with a metallic paint;
3. All removable bolts should have anti-seize applied to the threads in order to maintain ease of folding the tower or arch for storage.
4. To add luster to the tower or arch, wipe with a soft cloth and a small amount of baby oil.

M - 9 FLAG POLE & HOLDER

Feel free to show your colors with this available flag pole and holder (flag not included). The flag pole (available for most F series models) may quickly be installed or removed from its holder by pushing in and rotating the pole. See Figure M14. Please consult with your Four Winns dealer regarding inquiries with regard to this popular feature.



Figure M14: Flag Pole & Holder

N - 1 EXTERIOR SEATING
A. Bow Seating

Bow seating is provided on the F series models. The cushions are removable for accessing the storage areas below. See Figure N1.

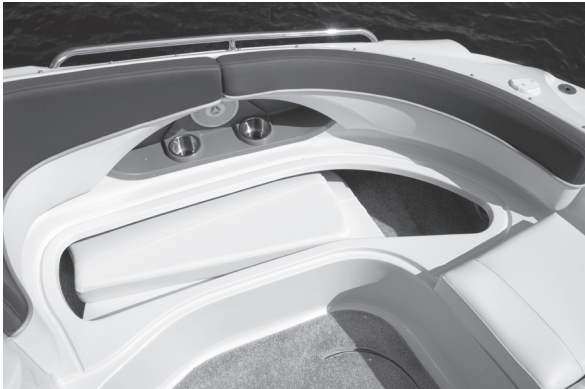

Figure N1: F series Bow Seat Storage
(Representative View - Models May Vary)

Bow fill-in cushions are available for most F series models. When installed, the fill-in cushions help form a sundeck across the bow area. These cushions may be stored in the walk-thru storage or bow storage areas, if applicable. See Figure N2.



Figure N2: F series Fill-In Cushions
(Representative View - Models May Vary)

B. Bucket Seats

The F series models have adjustable bucket seats as part of the seating configuration available. Also available on the bucket seats is a flip-up bolster. By placing the bolster in the raised position (if equipped) the driver is able to sit higher in the seat. This is designed to give the driver and passenger greater flexibility, increased visibility and riding comfort. See Figures N3 & N4.

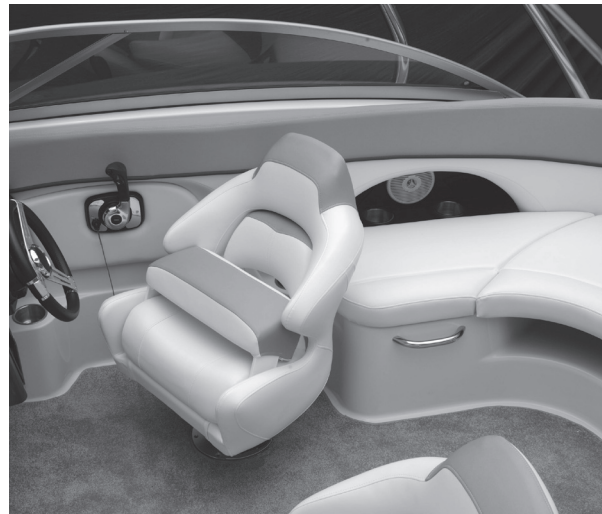

Figure N3: Helm Bucket Seat with Flip-Up Bolster - Up



Figure N4: Helm Bucket Seat

To manually adjust the position of the bucket seat lift up on the "Slide" handle located under the seat. Slide the seat forward or aft to the desired position. Release the "Slide" handle and it locks the seat into position. The seat will adjust approximately six (6) inches. See Figure N5.

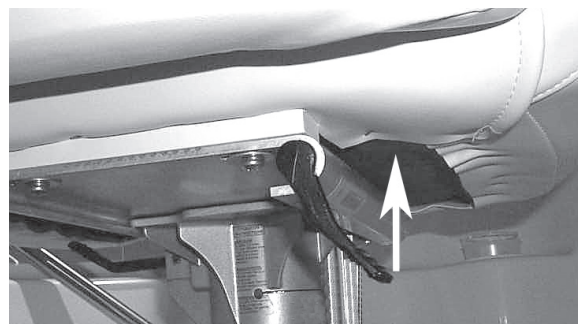

Figure N5: Bucket Seat "Slide" Handle

The driver's side bucket seat and the port side bucket seat can swivel and face toward the stern of the boat. When pulling a water skier, this permits the spotter to be in the proper position to observe. Depending upon which model you have, the bucket seat(s) may be limited in the amount and direction of swivel possible.

To rotate the bucket seat to face inboard:

1. Tilt the steering wheel (if applicable) as far forward as possible.
2. Locate the "Slide" handle (See Figure N5). Slide the seat either forward or rearward to clear the coaming/side pad or seat cushion. When at the desired position, release the handle and the slide will lock into position.
3. Locate the "Rotate" handle under the bucket seat. Lift upward on the handle to release the lock. This will allow you to rotate the seat. See Figure N6.

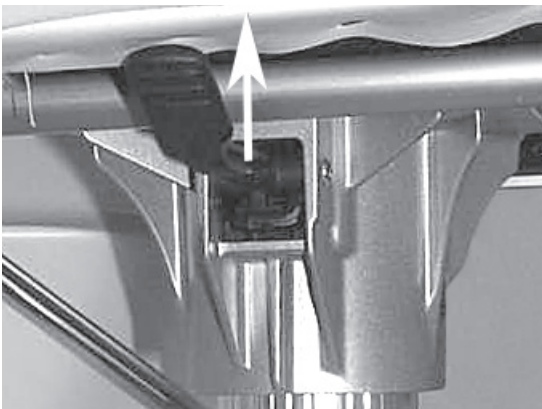

Figure N6: "Rotate" Handle - Release to Rotate

4. Rotate the seat inboard (towards the center of the boat) until it faces as far aft as possible or desired. Once in position, release the handle. To lock, slightly rotate seat until handle clicks and hardware locks securely into position. See Figure N7.

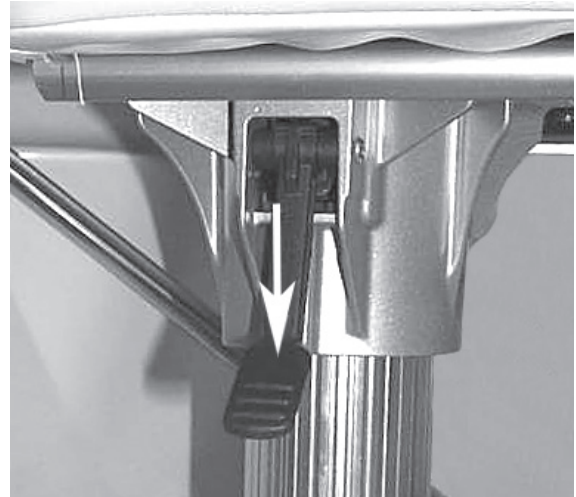

Figure N7: Rotate Handle - Locked Position

NOTICE

The bucket seats may or may not rotate completely 180°. The amount of bucket seat rotation may vary. The amount and direction of swivel available depends on the model you have and its placement in the boat.

NOTICE

*When rotating the bucket seat, damage to seat, steering wheel (if applicable), and/or coaming pad may result if attempting to rotate in the wrong direction or over-rotating. **DO NOT USE FORCE** to rotate the seat.*

WARNING

After rotating, ensure seat is securely locked into position. Sudden acceleration with seat unlocked could cause loss of balance and possible injury.

WARNING

***DO NOT** sit on the backrest portion of any cockpit seat. The operator could lose control of boat or passengers could be thrown from boat. Also, the seat may be damaged from improper use.*

Should you need to install the bucket seat or remove it from the pedestal please refer to Figure N8 and the manufacturer's instructions below.

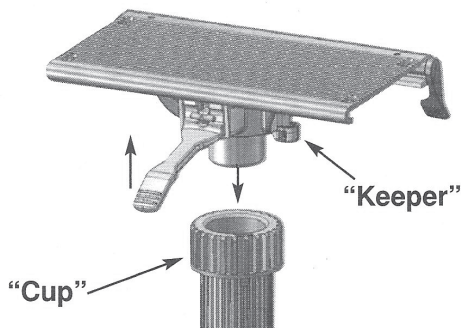

Figure N8: Pedestal "Cup" & "Keeper"

1. To install the seat slide system the "Keeper" will automatically move out of the way as the seat slide system is placed onto the pedestal. If the teeth of the cup are not aligned with the locking teeth of the seat slide system, lift up on the "Rotate" handle to pull the teeth out of the way.
2. To remove the seat slide system pull the "Keeper" away from the pedestal, lift the "Rotate" handle, and lift up on the seat.

The manufacturer's maintenance of the seat slide system has been also included to assist you. Please refer to following information and Figure N9.

1. Keep a light film of marine grade, lithium-based grease in areas shown to ensure continued ease of motion.
2. Periodically check and tighten all mounting hardware, attaching the seat slide system to the seat as well as the pedestal to the boat floor.

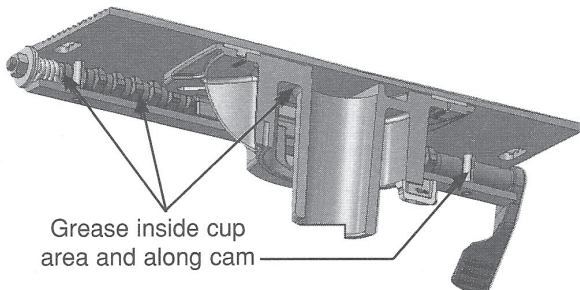

Figure N9: Cross Section of Seat Slider

C. U-shaped Stern Seating

U-shaped stern seating is found in the F series models. Large amounts of storage space are located under either the removable seat cushions or the hinged seat cushions. A transom walk-thru cushion and backrest door is removable to allow easy access from the swim platform to the cockpit. See Figure N10.

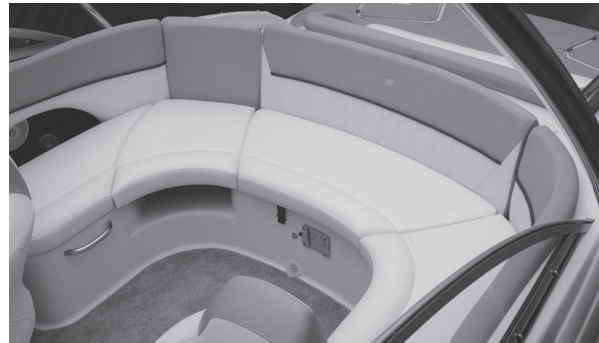

Figure N10: U-shaped Seating
(Representative View - Models May Vary)

NOTICE

Cushions, if not properly stored and/or secured, can blow out of the boat or become damaged.

D. Engine Hatch

Gas-assist lifts or hydraulic supports aid in raising the engine hatch along with keeping the hatch in the raised position when maintaining the engine. While these gas-assist lifts ease the amount of force necessary to manually lift or lower the engine hatch, a certain amount of effort is still necessary. See Figure N11.

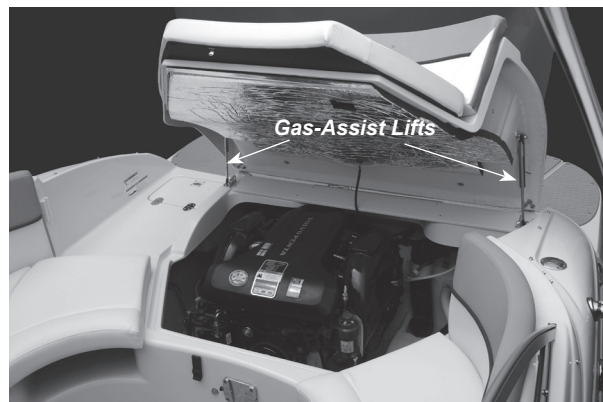

Figure N11: Engine Hatch
(Representative View - Models May Vary)

To raise the engine hatch:

With both hands placed underneath the center engine seat cushion, lift upward to raise position.

To close the engine hatch:

With both hands placed on top of the center engine seat cushion (engine hatch), apply an even downward force to close.

NOTICE

Placing an uneven force on the engine hatch may make closing more difficult. Possible damage to one or both of the gas-assist supports could also result.

NOTICE

Never operate or trailer your boat with the engine hatch in the raised position. Doing so could result in damage to the engine hatch, hardware, and/or cushions.

E. Sidewall Storage

The F series models have sidewall storage compartments. See Figure N12. This storage space includes drink holders and room for small items such as paperbacks, tanning lotion and sunglasses.

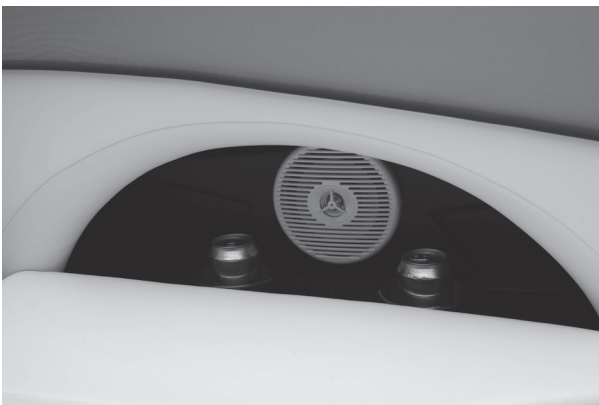

Figure N12: Sidewall Storage
(Representative View - Models May Vary)

F. Swim Platform Lounge Seating

Either dual or a single swim platform lounge seating is available equipment depending on the model. When utilizing the swim platform this seating provides added enjoyment and comfort. See Figure N13.



Figure N13: Swim Platform Lounge Seating

WARNING

Prevent falls overboard. Do not occupy swim platform lounge seat(s) when engine is running and boat is underway. Secure transom walk-thru backrest and stay inside cockpit while underway.

G. Fishing Seats

On certain F series models fishing seats may be available. The locations for the fishing seats (if equipped) are at the bow and aft areas respectively.

To install the fishing seat:

1. Place the fishing seat pedestal into the floor mount. Be sure the latch locks into place.
2. Place the stem of the stern seat onto the pedestal.

To remove the fishing seat, reverse the procedure explained in the preceding steps. To remove the pedestal, push on the release button and lift up.

WARNING

Failure to lock the fishing seat pedestal in place could result in injury. Be sure the pedestal is securely locked into place.

WARNING

To avoid possibility of occupant being thrown from boat, NEVER ALLOW ANYONE TO OCCUPY AN ELEVATED FISHING SEAT WHEN THE BOAT IS UNDERWAY AT MORE THAN TROLLING SPEED.

N - 2 EXTERIOR UPHOLSTERY CARE

A. Cleaning Vinyl

NOTICE

Vinyl upholstery should be cleaned and maintained in accordance with the manufacturer's recommendations and instructions.

The vinyl material used on the exterior upholstery should be cleaned regularly with warm water and a mild dish soap or Vinyl Finish Vinyl Cleaner® using a soft clean cloth, then rinse with a soft clean cloth. For dirt buildup, spray Vinyl Finish Vinyl Cleaner®, let soak for approximately ten (10) minutes, then gently scrub with a soft bristle brush. Be sure to thoroughly rinse the vinyl after washing with mild dish soap or Vinyl Finish Vinyl Cleaner® to remove all residue. Towel dry the vinyl. Periodic spraying of the seats with Lysol Spray Disinfectant™ will help retard mildew.

To further protect the vinyl from early degradation, use 303 Aerospace Vinyl Protectant®. Spray on, then wipe dry. 303 Aerospace Vinyl Protectant® should be applied every 3-5 weeks when boat is in use. Regular cleaning with mild soap and water or Vinyl Finish Cleaner will not remove the 303.

NOTICE

DO NOT apply vinyl protectants such as Armorall®. The manufacturer does not recommend this product because it removes the oils present in vinyl that keeps vinyl soft.

A recommended "Cleaning Kit" includes:

- Ivory Dishwashing Liquid™ and water
- Clean, white towels
- Soft bristle brush
- Denatured Alcohol
- Hemisphere Ink Remover®
(for ordering information call 800-247-9901)
- Vinyl Finish Vinyl Cleaner® -
(everyday cleaning & care, call 800-247-9901)
- 303 Aerospace Vinyl Protectant® -

(for ordering information call 800-247-9901)

- Tough Duty Cleaner™ - (to locate the nearest distributor, call 800-537-8990)
- Ammonia and hydrogen peroxide

To remove stains, follow the general guidelines listed below and/or refer to the Step-by Step Cleaning Instructions table:

General Stain Removal Guidelines

1. Basic Stains/Grease/Pencil/Dirt:

Ivory (mild) Dishwashing Soap™ and water, applied with a medium-soft brush or Vinyl Finish Vinyl Cleaner® using a soft clean cloth, then rinse with a soft clean cloth.

2. Tough Stains/Adhesive/Teak Oil/Rust:

Tough Duty Cleaner™; rinse with soap and water or spray with Vinyl Finish Vinyl Cleaner®, let soak for approximately ten (10) minutes, then gently scrub with a soft bristle brush. Thoroughly rinse vinyl and dry.

NOTICE

To prevent possible damage to the vinyl, rinse with soap and water after applying the Tough Duty Cleaner™ or Vinyl Finish Vinyl Cleaner®. Then rinse and dry.

3. Ink:

Denatured alcohol or Hemisphere Ink Remover®.

4. Mildew Stains:

To kill bacteria creating the mildew, vigorously brush the stained area with a 4-to-1 mixture of water and ammonia; rinse thoroughly with water and dry.

5. Tough Mildew Stains:

Apply a mixture of one (1) teaspoon ammonia, one-fourth (1/4) cup of hydrogen peroxide, and three-fourths (3/4) cup of distilled water; rinse with water and dry.

Step-by-step cleaning instructions			
Type of Stain	STEPS: 1,	2,	3
General Care	A	B	
Dirt Build-up	A	B	
Ballpoint ink*	E	B	A
Chewing gum	D	A	
Coffee, tea, chocolate	B		
Grease	D	B	
Household soil	A	B	
Ketchup	A	B	
Latex paint	A	B	
Lipstick	A	B	
Mildew or wet leaves*	C	B	A
Motor oil	B		
Oil-based paint	D	B	
Permanent marker*	E	B	C
Spray paint	B		
Suntan lotion*	A	B	
Tar / Asphalt	D	B	
Yellow mustard	A	B	C

Legend

A. Medium-soft brush, warm soapy water
Rinse / Dry

B. Vinyl Finish Vinyl Cleaner®
Rinse / Dry

C. One (1) tablespoon of ammonia; one-fourth (1/4) cup of water
Rinse / Dry

D. Wipe or scrape off excess (chill gum with ice before hand)

E. Hemisphere Ink Remover
Rinse / Dry

All cleaning methods must be followed by a thorough rinse with clean warm water.

Certain household cleaners, powdered abrasives, steel wool and industrial cleaners can cause damage and discoloration and are not recommended. Dry cleaning fluids and lacquer solvents should not be used as they will remove the printed pattern and gloss. Waxes should be used with caution as many contain dyes or solvents that can permanently damage the protective coating.

*Suntan lotion, tree pollen, wet leaves and some other products can contain dyes that stain permanently. Care should be exercised and boat covers should be utilized.

Step-By-Step Vinyl Cleaning Instructions Table

Do's

- Vinyl Finish Vinyl Cleaner
- Dish Soap (Dawn, Ivory)
- 303 Aerospace Vinyl Protectant

Don'ts

- Formula 409
- Fantastik
- Simple Green
- Armorall
- Murphy's Oil Soap,
- Son-of-a-Gun
- Bleach / Baking Soda
- Turtle Wax
- Tar Remover

NOTICE

Failure to care for your vinyl properly, or use of improper cleaners may void your warranty and damage your vinyl.

NOTICE

When docking or mooring your boat be aware of your surroundings i.e. trees with pollen, wet leaves, berries etc. These and other items can contain dyes that stain permanently. Utilize weather covers whenever possibly to protect vinyl from potential stains.

NOTICE

ALWAYS CLEAN STAINS IMMEDIATELY! DO NOT use Formula 409™ Fantastik™, Simple Green™, Armorall™, Murphy's Oil Soap™, Son-of-a-Gun™, Bleach / Baking Soda, Turtle Wax™ or Tar Remover on vinyl. Do not use kerosine, gasoline or acetone as they will remove the protective marine topcoat.

NOTICE

All cleaning methods must be followed by a thorough rinse with water and drying.

Additional cleaning information is provided by the manufacturer and is included with this manual.

Four Winns offers a variety of optional weather covers for protection of the boat and associated equipment. Continued exposure can damage the upholstery and seating. The seating can become thoroughly saturated with water if not adequately protected. Refer to Section O - Weather Covers for more information.

NOTICE

The appearance and longevity of the exterior upholstery will be affected by water saturation. Protect these items appropriately.

B. Exterior Carpets

The removable exterior grade carpeting is available and if installed may be periodically washed with mild laundry soaps or carpet shampoo, dried and reinstalled. It is 100% UV stabilized Olefin™ polypropylene fiber with rubber backing. See Figure N14.

NOTICE

Prior to using any mild laundry soaps or carpet shampoo, always conduct a color-fast test on a small inconspicuous portion of carpet before applying to entire carpet.

NOTICE

DO NOT dry carpeting in an automatic dryer.

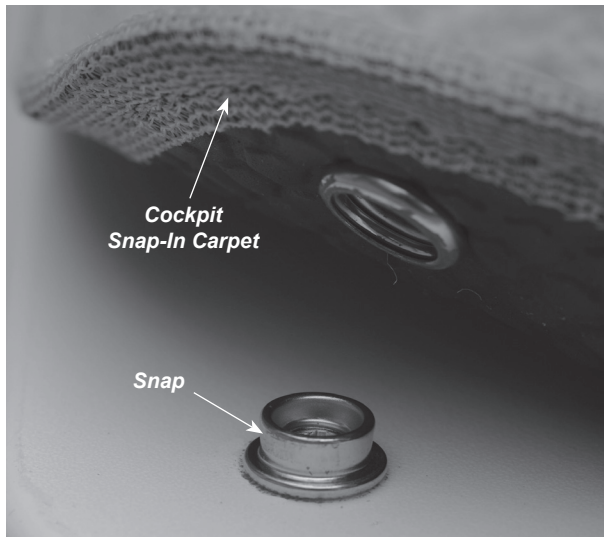

Figure N14: Cockpit Snap-in Carpet

C. Cleaning and Maintenance

The following information should be useful in helping you keep your carpet looking well maintained.

Carpet made with Olefin™ fiber possesses built-in stain and soil release for easy, less costly maintenance. Regular vacuuming and occasional shampooing will help it stay attractive and serviceable.

D. Stain Removal Testing

Even the most stubborn stains can be removed from Olefin fiber following the procedures outlined. Stains were selected as being representative of spills commonly occurring on carpets. Stains were pressed into the carpet to simulate foot pressure following a spill. Stains were applied to a two-inch square section and allowed to penetrate. Removal was performed after two weeks. Carpets were tested for stain removal by an independent laboratory. Stain removal was effective for all the stains selected. Results are shown in the table on the following page.

E. Stain Removal Procedures

Regular maintenance such as vacuuming, hosing or washing should be performed. Most stains and mildew are easily removed from carpet made with Olefin fiber using common household cleaners. Refer to Table I. Olefin™ fiber is so resistant to chemical

attack that Clorox™ bleach may be used to clean up any mildew that may result from excessive wetness.

Code for stain removal procedure (See Table 1):

“A” Apply warm water and household detergent in minimal amounts to stained area. Sponge or scrape until stain is removed. Rinse with clean water.

“B” Apply warm water and household detergent. Work well into stained area then flush with warm water.

Most stains should be easily removed however, if the stain persists, the cleaning procedure should be repeated to insure stain removal. Remember, the sooner the stain removal process begins, the easier the stain will be to remove.

NOTICE

Do not use dry cleaning solvents on carpet or vinyl. Permanent damage to the fiber will result.

N - 5 REPLACEMENT UPHOLSTERY

Should upholstery become severely soiled, torn, or in some manner damaged, replacement upholstery cushions are available. Larger upholstery items have separate component parts for easier serviceability. Depending upon the year and model of the boat, most upholstery parts can be obtained through your Four Winns servicing dealer within a short period of time.

STAIN	REMOVAL PROCEDURE
Automotive Grease	A
Automotive Oil (New or Used)	A
Bacon Grease	A
Berry Stain	A
Blood	A
Butter	A
Catsup or Mustard	A
Chewing Gum	A (Repeat)
Chlorine Bleach (5%)	A
Chocolate (Melted)	A
Clay	A
Coffee or Tea	A
Cola	A
Crayon	B
Dye	A
Egg	A
Feces	A
Fish Formula	A
Fruit Juice	A
Furniture Polish	A
Gravy	A
Ice Cream	A
Ink (Permanent Black)	B
Ink (Scripto, Ballpoint)	B
Iron Rust	A
Lipstick	B
Mayonnaise	A
Milk	A
Latex Paint	A
Oil Base Paint	B
Polish	B
Rust	A
Salad Dressing	A
Shaving Cream or Lotion	A
Tar	B
Urine	A
Vomit	A
Water Colors	A
Wax	B
Wine	A

Table I: Stain Removal



O - 1 GENERAL INFORMATION

Weather covers for the cockpit areas are available on all F series models. Four Winns covers are designed and intended to provide protection of the cockpit seating areas.

Four Winns utilizes acrylic-type material for all its covers. All F series canvas except mooring covers consist of 100% acrylic material and is color matched to the boat. The mooring covers are made of 10-ounce acrylic and typically come in tan only. Contact your Four Winns Dealer for availability.

CAUTION

Never use any form of open flame cooking device while under, in any area fully enclosed, or near any acrylic weather cover. This material is flammable.

During the manufacture of the weather covers, the smallest possible needle and highest quality UV stabilized, bonded polyester thread is used in the stitching.

The weather cover is water repellent but not water proof. During a hard rain, you may notice a light mist permeating through a weather cover. This is normal. If the seams leak, they can be sprayed with Scotch-guard™ or similar water repellent or a seam sealing compound can be applied. Keep objects from contacting the inside of the cover. Leakage may occur at point of contact.

Weather covers must be installed taut or will be damaged by accumulation of rain water.

NOTICE

Periodically check weather covers for accumulation of water. Damage to the bow assemblies may otherwise result. Make sure cover is taut to avoid puddling of water.

After use, the top canvas should be rolled up into the boot (if supplied) and secured.

NOTICE

NEVER fold or store a wet weather cover. This can lead to mildew or shrinkage. Roll rather than fold the enclosure curtains. Sharp folds increase the chance of cracking the clear vinyl.

NOTICE

DO NOT use the weather covers for outdoor winter storage. The weight of the snow or heavy rain can cause severe damage to the material or top structure. Refer to O-3 Winter Storage in this manual for more information.

When snapping covers to the boat, apply direct downward pressure on the snap. When unsnapping, rotate the snap and cover upward at each snap location.

NOTICE

Remove snaps one at a time to prevent damage. DO NOT rip off or pull the weather cover as a whole; acrylic material may tear at snaps.

A. Bimini Top (Aft/Main)

A bimini top is available on most F series models. This style is a “freestanding” top and supported only by the bow assembly. Note: This style of canvas when deployed permits most occupants the ability to stand and walk about the cockpit while the boat is at rest. Refer to Figure O1.

To install:

1. Attach the bimini main bow to the deck mounts.
2. Attach the forward nylon straps or the brace rods (depending on the model) to the strap eyes or deck mounts located on the deck respectively.

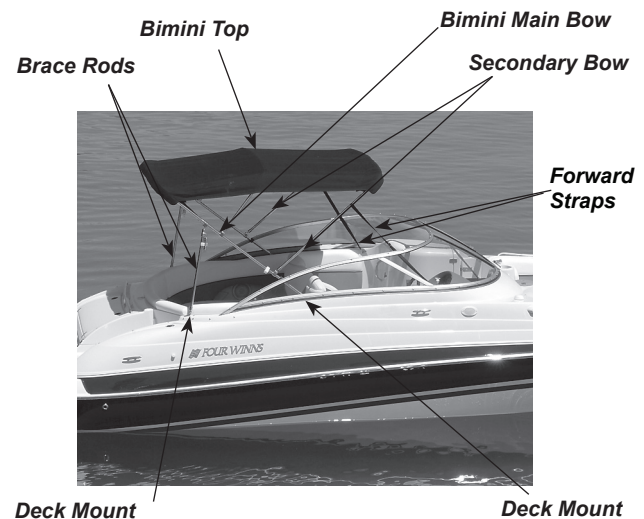

Figure O1: Bimini Top
(Representative View Only - Models May Vary)

3. Attach the brace rods to the stern deck mounts.
4. Adjust the straps (if applicable) for tautness.

To close and boot (mounted storage) the bimini, reverse the procedure described above. Brace rods, if applicable to your model, snap into storage clips for safe keeping while booted.

You may choose to run your F series with the bimini top either fully deployed or folded together (closed) and secured with the boot provided. Either way it is designed to remain mounted. No storage is provided for this top in your boat.

NOTICE

Use two people to remove the bimini top (winter storage). This will help minimize the risk of injury and help prevent damage to the upholstery, the bimini top, and/or the boat.

NOTICE

Aft/main bimini canvas deployment should only be utilized at or below moderate cruising speed (approximately 0-40 mph). Avoid full throttle operation of boat while having canvas deployed. Four Winns recommends booting the canvas before running at or close to maximum speed. In so doing you will help to maintain the life of the canvas and hardware. Also, the wind should be taken into consideration when determining operating speed with canvas deployed. The boat speed plus (+) wind speed should not be exceed 40 mph.

B. Forward Bimini Canvas

A forward bimini top is available on certain F series models. If equipped, the forward bimini provides shade for persons occupying the bow area. The forward bimini attaches to the aft/main bimini canvas. See Figure O2.

To install:

1. Attach the forward bimini main bow to the deck mounts.
2. Zip the forward bimini top to the aft bimini top.
3. Attach the forward brace rod to the deck mounts located on the deck.

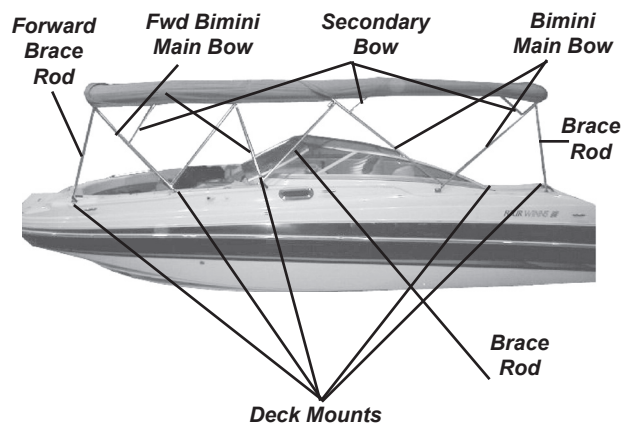

Figure O2: Forward Bimini & Aft/Main Bimini Top
(Representative View Only - Models May Vary)

C. Camper Canvas

The camper canvas is available on certain F series models. The camper canvas encloses the cockpit area and allows for overhead space. The F series camper utilizes the aft bimini top along with other various canvas pieces. Covers roll up to expose the window screens. See Figure O3. Your Four Winns Dealer will gladly assist you with your canvas selection as well as the installation.



Figure O3: Camper Canvas

To install:

1. Install bimini top(s) as previously instructed.
2. Depending upon model, zip the side curtains and forward connector. Snap the bottom portion of these curtains to either the top edge of the windshield or the deck respectively.
3. Unroll the aft camper curtain and attach forward edge of aft camper canvas to bimini zipper.
4. Depending on which the model you have either snap the bottom portion of the aft curtain to the transom and/or attach shock cords to deck.

For camper storage, reverse the procedure described above.

NOTICE

DO NOT FOLD THE AFT OR SIDE CURTAINS! Damage may result. Always roll the side and aft curtains up to prevent damage to the isinglass (clear plastic).

This camper is designed as temporary shelter only. It should not be left up unattended for any extended length of time. Violent weather could result in expensive damage. Misuse is not covered under warranty.



D. Forward Cover

The forward cover is available on the F series models. It is installed over the bow seating area and is snapped to the deck and to the cockpit cover at the walk-through. An adjustable pole is provided to adjust the canvas for tautness. See Figure O3.

NOTICE

The front center snap of the forward cover should be centered on the center bow stud at the bow. The front center snap is located at the front of the forward cover at the center seam.

E. Cockpit Cover

The cockpit cover is used to cover the complete cockpit area and is intended as a short term storage cover. The cockpit cover is available on the F series models. See Figure O4.



Figure O4: Forward & Cockpit Cover
(Representative View Only - Models May Vary)

To install:

1. Snap the forward edge of the cockpit cover to the walk-through on the windshield. Windshield snaps will slide to adjust to the canvas.

NOTICE

The front center snap of the cockpit cover should be centered on the center windshield snap on the windshield track. The front center snap is located at the front of the cockpit cover at the center seam.

2. Secure the rear corners.
 - a. If the canvas has snaps along the aft edge, secure the corners.
 - b. If the canvas has shock cords along the aft edge, attach to knobs as shown in Figure O5.

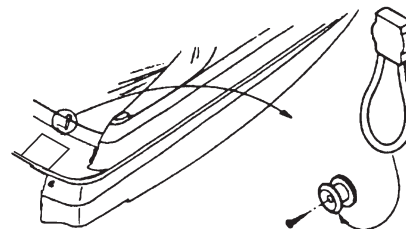

Figure O5: Shock Cords

3. Snap the cockpit cover sides and rear (if applicable) to the deck.

An adjustable pole is provided to adjust the canvas for tautness.

F. Mooring Cover

Mooring covers, available for the F series models, are intended for longer term storage and spread over the entire boat. If used in areas with snow accumulation, be sure to support the canvas adequately and inspect frequently for snow loads or damage will occur. Refer to O-3 Winter Storage for additional information. See Figure O6.



Figure O6: Mooring Cover
(Representative View Only - Models May Vary)

To install:

1. Spread mooring cover over entire boat.
2. Install adjustable poles in bow area and in the rear cockpit. Be sure the canvas is taut and no pockets exist.
3. Tie off at the transom.
4. Nylon loops are provided for attaching rope or bungee cords to the trailer or from side to side (under the boat).

O - 2 TRAILERING

High winds encountered during trailering your boat can severely damage most weather covers. If an extended trip at highway speeds is planned, the top and other weather covers should be in the down position or removed entirely. This will prevent damage and loss.

NOTICE

DO NOT tow your boat at highway speeds with weather covers in place. High winds encountered during trailering your boat can severely damage most weather covers. Damage to weather covers incurred as a result of trailering your boat is not covered under warranty.

O - 3 WINTER STORAGE

The boat must be properly protected during winter dry dock storage. A winter storage cover is advisable. Many marine dealers offer shrinkwrap enclosures for outdoor storage. See a Four Winns dealer for information on the availability of winter storage covers or other alternatives for storage.

When storing outdoors, make sure the supporting framework keeps the weight of the snow and rain from accumulating on the storage cover. Proper ventilation must also be provided or dry rot and mildew will occur. See Section R General Maintenance for additional winter storage information.

O - 4 USE OF WEATHER COVERS AND CARBON MONOXIDE

When an engine is running, a natural vacuum may exist with the right wind and sea conditions to allow exhaust gases (which includes carbon monoxide) to seep into the boat. When canvas is utilized, this compounds the possibility of this occurring and inhibits natural ventilation. For more information, refer to Section B-2 - Carbon Monoxide in this manual.

The carbon monoxide in exhaust fumes can be hazardous. It is important for you and your passengers to be aware of the potential safety hazard created by exhaust fumes. Familiarize yourself with the symptoms of individuals overcome by carbon monoxide, and most importantly, ways you can protect yourself and your guests. See Figure O7 - Carbon Monoxide Canvas Warning Label and Figure O8 - Carbon Monoxide Warning Label - Helm.

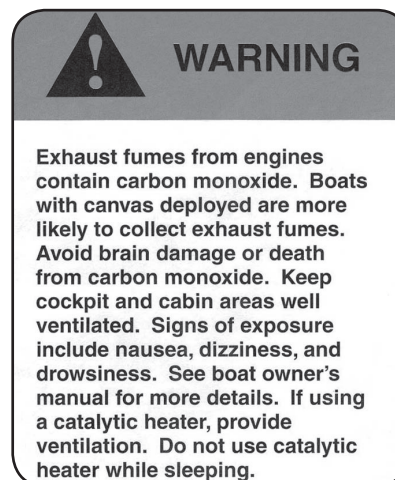

Figure O7: Carbon Monoxide Canvas Warning Label

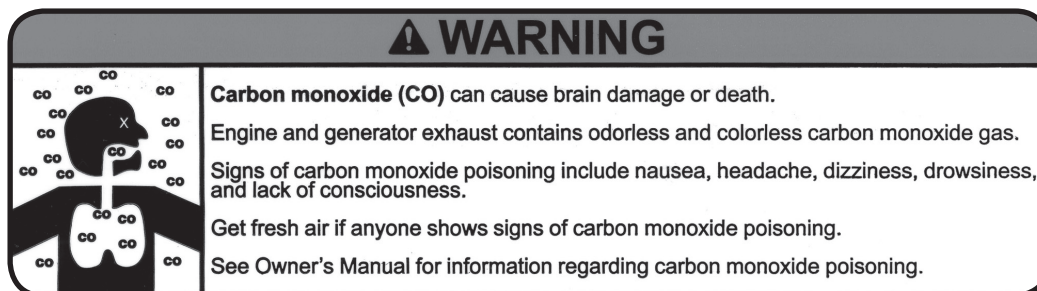

Figure O8: CO Warning Label - Helm

O - 5 MAINTENANCE

Figure O9: Canvas Care & Maintenance Tag

Moisture, dirt, chemicals from industrial fallout, heat, ultraviolet rays and in some cases, salt water are factors which affect the longevity of acrylic covers. See Figure O9.

1. Moisture can cause shrinkage and mildew. Allow the cover to dry thoroughly before disassembling tops. Keep it clean and well ventilated to prevent mildew. Spraying the weather cover with Lysol Disinfectant™ or similar product will help prevent mildew.
2. Dirt creates a starting point for mildew when moisture is present. Clean the top with a sponge or soft scrub brush and mild detergent when the cover is installed. Make sure cover is taut to help prevent shrinkage.
3. Chemicals cause decay if allowed to accumulate for long periods of time. Keep the cover clean to prevent decay.
4. Heat can cause cracks in vinyl components and stiffening of fabric when enclosed in plastic or polyethylene. **DO NOT** store the weather cover in polyethylene under direct sunlight or high temperature situations.
5. Ultraviolet degradation may occur under prolonged exposure to direct sunlight. Store the top in the boot when not in use.

6. Salt water can corrode brass, aluminum, or stainless steel fittings and fasteners. Keep fittings clean, lubricated, and waxed to prevent corrosion.

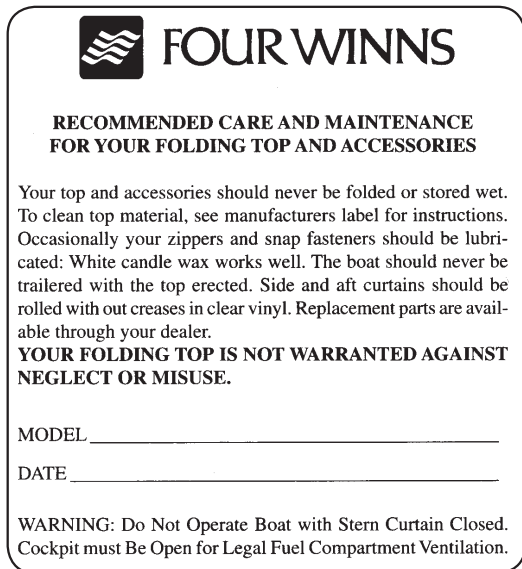
Clear vinyl curtains and windows demand extra care to prevent scratching. **DO NOT** use cloth or chamois skin. Dirt or grit in the cloth will scratch the vinyl window. Using a hose, apply clean water to the clear vinyl and rinse off all salt, dirt, and/or grime.

NOTICE

DO NOT use hot water. DO NOT dry in an automatic dryer. DO NOT dry clean or steam press.

Leakage after cleaning may be the result of insufficient rinsing. Re-rinse. If leakage continues, apply a coat of silicone air drying water repellent, such as Scotchguard™. See your Four Winns dealer for additional information on weather covers.



P - 1 HULL DESIGN INFORMATION

Four Winns® boats are designed using the sound engineering and mathematical principles of hydrostatics, hydrodynamics, structure, and strength of materials. The materials utilized provide optimum strength at the lightest possible weight. The exact fiberglass laminate schedule and construction techniques of each part is determined in accordance with the strength and rigidity required.

P - 2 FIBERGLASS CONSTRUCTION

The fiberglass components of Four Winns® boats are of the finest quality materials, workmanship and construction techniques available. This ensures the structural integrity to provide years of boating enjoyment with minimal maintenance.

The construction of a Four Winns® hull begins with the application of gel coat to the mold. The gel coat is approximately 25 mils thick. A coat of resin and chopped fiberglass is then sprayed into the hull and carefully hand-rolled until it is securely affixed to the gel coat.

A number of fiberglass layers and woven roving are applied to the above laminate. Each layer is hand-laid and hand-rolled. The keel and chine areas have fiberglass woven roving overlapped in these areas to provide additional strength. Some models utilize encapsulated end-grain balsa core or coremat laminates to achieve additional rigidity. Others utilize additional laminations of woven roving to maintain strength and rigidity.

The hull support stringers are located using special tools, and are fiberglassed/bonded into place. This ensures a strong, rigid hull, permanently formed into a solid assembly, free of distortions.

Fiberglass cockpit liners and seat base are constructed similar to the hull. Balsa core or coremat laminations are utilized when necessary.

In addition to a thorough visual inspection of each fiberglass component, samples are measured using special equipment, for fiberglass reinforcement to resin ratio, laminate configuration, weight and thickness. By these procedures Four Winns ensures proper composition.

P - 3 EQUIPMENT INSTALLATION

Many boats are used for specific purposes or under conditions which require the addition of special equipment to the hull or deck. Special care must be taken during the installation of any equipment to a fiberglass component. A polysulfide or butyl based sealant should be used to seal installations below the water line. Silicone "marine" seal or similar bedding compound should be used elsewhere.

NOTICE

DO NOT install any item onto or through the hull without adequately sealing the hull area penetrated by the installed item or related fasteners. Improper installations could cause leakage or allow water absorption and thus cause serious hull damage.

Always pre-drill fastening holes with a proper size bit. Pre-drilling will help prevent the fiberglass from splintering and thus causing unsightly damage. Also, countersink holes to prevent the gel coat from chipping.

Any equipment which will be subjected to cyclic loading or significant force should be through-bolted to a fiberglass component. A butt block or backing plate should be used to strengthen any area onto which an item will be mounted.

P - 4 FIBERGLASS CARE & MAINTENANCE

Fiberglass is affected by weathering processes and requires maintenance on a periodic basis to help maintain the beauty and shine. The effects upon the gel coat will be dependent upon boating conditions, storage, type of use, and the care given to the boat during the boating season.

Four Winns® utilizes fade-fighting gel coat in the exterior finish. It is specially formulated to resist fading and yellowing, and retain more of its original gloss than lesser grade gel coats. However, it is still important to maintain the gel coat to protect the finish.

A. General Maintenance

For freshwater use, the boat should be washed once or twice a month. When using in a salt water environment, considerably more care will be necessary. Be careful when selecting a cleaning agent. Hand dishwashing detergents are usually gentle and are recommended for cleaning gel coat. Cleaning

products such as Ivory or Dawn hand dishwashing liquid can be safely used. Always read the label before using any product.

NOTICE

DO NOT use acetone, paint thinner, solvents, or strong alkaline based detergents, nor cleaners with a “gritty” and abrasive texture. Avoid products which contain sodium phosphate. Common examples of these types of household cleaning agents are: Tide™, Oxydol™, Janitor-in-a-Drum™, Formula 409™, Clorox™, etc. Always read the label before using an agent.

There are several products available which are specifically designed to clean fiberglass exterior finishes. Many companies like Johnson & Johnson®, Turtle Wax®, etc. manufacture cleaning fluids mild enough to clean without stripping the wax.

NOTICE

Treading on a soiled fiberglass surface can severely scratch and mar the finish. Keep the fiberglass as clean as possible.

When cleaning nonskid areas, DO NOT attempt to use a wire brush or sandpaper because this will remove the non-skid gel.

Apply wax once or twice a year to maintain gel coat lustre. Read the label before using any product. Make sure product is formulated for gel coat surfaces. Also, consult a Four Winns dealer for their recommendations.

NOTICE

Do not use carnuba-based waxes. This type of wax yellows over time and makes the fiberglass appear yellow.



Waxing decks, cockpit floors or other areas on which one walks is not recommended. Waxing will produce a very slippery surface, especially when wet. Wax may also buildup in the nonskid surfaces. Be sure all persons wear deck shoes while aboard the boat. Footing will be improved and feet will be protected from accidental cuts and bruises.

A darkening or discoloration of the non-skid surfaces can sometimes occur as a result of wax buildup. Exposure to the sun and elements can turn the wax darker, or occasionally can cause it to become flaky or powdery. To remove, use fine rubbing compound and a low RPM buffer (1200 to 2000 RPM). Apply light pressure and keep the buffer moving at all times to prevent heat build up. Read the directions before using any equipment.

B. Weathering Effects on Gel Coat

Weathering occurs from direct sunlight, water, chemicals, and dust. Some of the terms below describe the changes that can occur to the gel coat surface.

Chalking is a result of the gel coat's top surface being broken down into an extremely fine powder. When this happens, the color whitens. The chalk is present on the surface only.

Fading is the uniform change in color. This happens when the actual pigments have changed color, especially from excessive chalking, or when the gel coat has either been stained or bleached by something.

Yellowing is gel coat which has a yellow cast and streaking usually deals with a stain or contact with another surface.

Gloss refers to the shine of the surface. This can change from sanding action, chalk, residues, or exposure.

Blistering refers to a condition in which the unprotected gel coat surface below the waterline has absorbed water and formed bubbles. See Section P-5 for additional information.

Follow the instructions below for boats that have weathered and chalked.

1. Wash.
2. Wax. If this does not work, then use a fine rubbing compound. If this does not work use 400 or 600 wet or dry sandpaper, followed by fine rubbing compound and wax.

When using wax or fine rubbing compounds, make sure to read the label and follow the directions. Some helpful tips are as follows:

1. Avoid working in direct sunlight. This dries out the wax or compound, and can stain the surface.
2. Use clean pads or cloths to apply a thin coating of wax or rubbing compound to a small area such as three feet by three feet. Remove any excess, and then rub the area with a buffing pad, or power buffer. Apply pressure only as necessary to restore the surface finish. Applying too much pressure or buffing in one place too long can permanently damage the surface.
3. After applying compound, always follow with waxing.

NOTICE

If using a power buffer, use a low RPM buffer with light pressure. Keep the pad wet and the buffer moving at all times to prevent heat build up.

NOTICE

When sanding, DO NOT use a power or belt sander. Gouges, uneven areas, or other damage could occur. For best results, block sand the gel coat.

C. Stains

Stains can appear anywhere on the exterior of the boat and may be a result of contact with tar, plant sap, leaves, rust from metal fittings, and other materials. Surface stains may be removed with hand dishwashing soap, mild cleansers, or some household detergents. DO NOT use chlorine or ammonia products. These products can affect the color of gel coat. Commercial car washes use strong cleaners and should be avoided.

To remove stains, refer to the procedures below.

1. Wash area with hand dishwashing soap.
2. Begin with a small area such as three feet by three feet and apply a mild cleanser.
3. Rinse with clean water.
4. Follow with compound and waxing as outlined in procedure above.

If the stain is not removed by the hand dishwashing soap or mild cleanser, then the next procedure is to

use either denatured or rubbing alcohol. If this does not work, consult your Four Winns dealer for professional assistance.

NOTICE

DO NOT use acetone, ketone, or other solvents to remove stains. These chemicals are flammable and may damage the gel coat.

P - 5 FIBERGLASS REPAIRS

Fiberglass is one of the most durable, strong, and forgiving construction materials afloat. It is resilient and normal repairs can be made without affecting the strength or structural integrity of the boat.

 **WARNING**

Striking docks, other boats, or submerged objects could create a very hazardous situation or severely damage the fiberglass. In the event an object is struck below or near the waterline, proceed directly and cautiously to the nearest service facility and remove the boat from the water. Closely inspect the hull for damage. If the outer fiberglass laminate was penetrated, repairs must be made prior to relaunch.

Occasionally, blisters, crazing, scratches, or damage to the fiberglass can occur. Repairs may be necessary to correct the problem.

A. Scratches

Scratches occur during normal use. Below is a step by step procedure to repair scratches.

1. Clean area with soap and water.
2. Apply a fine rubbing compound and buff.
3. Wax. If this does not work, clean the area and sand lightly with 400 to 600 wet or dry sandpaper and follow with rubbing compound and wax.

B. Gouges & Cracks

Stress cracks and crazing are the appearance of hairline cracks in the gel coat surface. When present, these problems usually occur in the gel coat finish or the outer "skin coat" fiberglass laminate. The appearance of these cracks does not pose a threat to the structural integrity of the boat. In most cases, they are

cosmetic and can be treated. Cosmetic surface damage can be repaired as follows:

1. Sand the surrounding area with medium or fine grit sandpaper. Clean all marine growth, dirt, anti-fouling paint, etc. from the immediate area. DO NOT excessively scratch or gouge the surrounding area.
2. Use a hard, pointed tool to open the gel crack. Take care not to damage the surrounding gel coat.
3. Sand the crack or gouge so the edges are smooth and will allow proper “feathering” of the area.
4. Clean the area thoroughly. Make sure the area is dry before proceeding.

NOTICE

Be sure the structure and the ambient temperature are above 60 degrees F (15 degrees C) and the relative humidity below 70% immediately before, during, and after the repair.

5. If the nick or gouge is deep and penetrates through the gel coat, fill the area with fiberglass patching paste. Follow the directions on the can when mixing the paste with the catalyst.
6. After the gouge is filled and has dried, sand the patched area. Begin by using medium-fine grade sandpaper. Progressively use finer grade sandpaper until the surface is very smooth. If necessary, add filler and then sand the surface again.
7. Apply two or three light coats of matching fiberglass gel coat to the repaired area. Enough gel coat should be used so that the entire area is covered.

The gel coat must be catalyzed using up to 2% MEK Peroxide which can be purchased at a supplier handling fiberglass reinforced products. Contact your Four Winns dealer for assistance.

8. After ample drying time, sand the area using very fine wet/dry sandpaper. If the appearance of the area is still not satisfactory, repeat steps 2 through 8 as necessary.
9. If above the waterline, polish the area using a fiberglass rubbing compound and then wax. If the repaired area is below the waterline, the area should be primed and painted in accordance with the anti-fouling paint manufacturer’s instructions.

Gel coat, like paint, will change colors with time and exposure to sunlight (ultraviolet). For this rea-

son, “matching” gel coat obtained from Four Winns may not match the gel color of a boat that has been exposed. However, this is the closest match commercially available. A fiberglass/gel coat technician can tint the gel to be used in the repair to provide a closer color match.

More severe fiberglass damage, especially when structural, requires the expertise of an experienced fiberglass repair technician. See your Four Winns dealer for assistance.

NOTICE

Improper repair techniques can lead to further fiberglass component damage.

C. Osmotic Blistering

Osmotic blistering or “boat pox” is an unfortunate but not uncommon occurrence in fiberglass boats. Fiberglass is water retardant, not waterproof. When a boat is left in the water for a period of time, the fiberglass will absorb water. It is a natural process that can not be eliminated in production methods or material selection and usage. However, there are ways to control and possibly prevent blisters (see Section P-6). If you do encounter blisters, be assured that the blisters are merely cosmetic. They do not indicate a defect in the boat structure or lamination. Four Winns, along with most boat manufacturers, regard gel blisters as a standard maintenance item.

The repair procedure for gel coat blisters is similar to the procedures outlined in the previous section on cracks and gouges. There is an exception however, in that the hull must dry out for several days or possibly weeks before repairs can proceed.

To determine if the hull has dried sufficiently, tape one square foot of household plastic wrap securely to the hull bottom. Make sure all edges are sealed and let it stand for twenty-four hours. If condensation has accumulated under the plastic, the hull is still “wet” and must be allowed to dry longer before repairing.

When the repair is completed, an application of an epoxy barrier coat should be considered. This will help prevent the possibility of reoccurrence of blisters. Your Four Winns dealer or local ship store will have information on barrier coat products.

P - 6 ANTI-FOULING PAINT

Four Winns recommends anti-fouling or bottom paint for boats which will be kept in the water for extended periods of time. Anti-fouling paint reacts with water to retard the growth of algae, barnacles and other marine growth on the hull. In addition to marine growth, it offers protection against excessive water pollution.

Anti-fouling paint begins reaction upon contact with water. After a season's use or sooner under certain conditions, the anti-fouling paint may appear to be dissolving. This is due to the paint's chemical emission that in turn retards marine growth. When this occurs, refinishing is in order.

Four Winns recommends reapplication of the anti-fouling paint seasonally. The effectiveness of the paint will be drastically reduced if used longer. Though Four Winns has found the use of anti-fouling paints provide good marine growth protection in most water, other paints may be more effective in certain water conditions. See a Four Winns dealer for recommendations on anti-fouling paint use in your area.

NOTICE

During surface preparation, the hull should be sanded only enough to remove any foreign matter, and loose paint. DO NOT sand deeply into the gel coat, fiberglass cosmetic problems could later result. After sanding, the surface should be wiped with a rag treated with a cleaner recommended by the anti-fouling paint manufacturer. The surface must be clean and slightly rough to ensure proper paint adhesion.

Prior to application of the anti-fouling paint, the boat owner may consider coating the hull bottom with an epoxy coating. Four Winns recommends this procedure as a preventive and effective means of controlling osmotic blistering. Most major anti-fouling paint manufacturers also supply a line of epoxy undercoatings. Consult your Four Winns dealer for recommendations on epoxy undercoatings.

P - 7 HULL SUPPORT

Proper support of the hull while it is out of the water is imperative. Due to the design complexities, Four Winns does not recommend trailers or storage cradles be homemade. The boat is a valuable piece of equipment. DO NOT risk permanent damage to the hull structure in an attempt to save the cost of an adequate support. Improper support can lead to serious and permanent hull deformation.

CAUTION

Failure to adequately support the hull may result in permanent hull structure damage and will invalidate the hull structure warranty.

NOTICE

When attempting to raise the hull, never allow one end of the boat to rise first, while letting the opposite rest momentarily on the outdrives or underwater gear. Serious damage to these components could result. DO NOT place lifting straps on underwater gear. Be sure the strap is against the hull surface only.

A trailer, or storage cradle designed for a larger or smaller boat will not provide proper support for the hull. This could lead to hull deformation and thus serious performance deficiencies.

Four Winns® trailers are available for most models. Refer to Section S - Trailers for additional information.



NOTICE

Models may vary with regard to content based on standard and options availability.

Q - 1 HIGH-PRESSURE LAMINATE CARE

On certain Four Winns® models, table tops, counter tops, cabinets, shelving, headboards, support boards and drawer faces may consist of a high pressure laminate material. The laminate may have either a matte texture or smooth finish and can be cleaned with mild dishwashing soap and water. Always read the label before using any product.

NOTICE

DO NOT use abrasive cleaners or solvents on formica. DO NOT use Soft Scrub™ soap or similar cleaning products; they will scratch the surface and remove the shine.

NOTICE

DO NOT use table tops as a cutting board. The knife will leave gouges/marks in the surface of the table.

Q - 2 STAR BOARD

Star board is a high density polyethylene (plastic) and is very durable and fade resistant. Star board requires little maintenance, and is being used in place of wood in certain areas of the boat. The ski locker lid is one example of where star board is used. See Figure Q1.



Figure Q1: Ski Locker Lid

To clean star board, use a solvent-free, nonabrasive cleaner such as dishwashing soap or Fantastic™. Read the label before using any cleaning product.

NOTICE

Star board will stain when exposed to certain oils or chemicals. Always wipe up any spills immediately.

Q - 3 METALLIC FINISHES

Metallic accents may be found on certain F series models. The metallic trim gives the dash a rich, clean and contemporary look. See Figure Q2.



Figure Q2: Metallic Accents - Helm

To clean, a damp cloth will usually suffice.

Q - 4 LAMINATED FIBERGLASS

The decks and cockpit flooring are made up of laminated fiberglass. Cleaning can be done using mild dishwashing soap and soft nylon brush. Rinse thoroughly with clean water after scrubbing with the brush. See Figure Q3.



Figure Q3: Cockpit Floor

A removable cockpit table is available on the F series models. The table also consists of a laminated fiberglass material. See Figure Q4. It can be cleaned with mild dishwashing soap and water. Always read the label before using any cleaning product.

NOTICE

DO NOT use abrasive cleaners or solvents on cockpit table. DO NOT use Soft Scrub™ soap or similar cleaning products; they will scratch the surface and remove the shine.

NOTICE

DO NOT use cockpit table as a cutting board. The knife will leave gouges/marks in the surface of the table.



Figure Q4: Cockpit Table

Q - 5 SOLID SURFACE MATERIAL

On models with a refreshment center, a solid surface material is used for the countertop. The solid surface gives the refreshment center a rich look and makes for an extremely strong yet lightweight top. It can be cleaned with mild dishwashing soap and water. Always read the label before using any product. See Figure Q5.



Figure Q5: Refreshment Center
(Representative View - Models May Vary)

Q - 6 ACRYLIC PLASTIC - (Plexiglass)

Acrylic plastic is utilized in most walk-thru doors, windscreens, transom doors, portlight windows, electrical panel doors and certain glove boxes. See Figure Q6.



Figure Q6: Walk-thru Doors
(Representative View - Models May Vary)

To clean acrylic plastic:

1. Rinse with plenty of water to wash off as much dirt as possible.
2. Using your bare hand, along with plenty of water, feel and remove any dried-on dirt or mud.
3. Wash using a soft, grit-free cloth or sponge and mild, nonabrasive soap or detergent.
4. Rinse thoroughly with water.
5. Blot dry using a clean, damp chamois.

NOTICE

Never use a dry cloth, duster, glass cleaning solutions or citrus cleaner on acrylic plastic.

NOTICE

Do not use solvents such as acetone, silicone spray, benzene, carbon tetrachloride, fire extinguisher fluid, dry cleaning fluid, lacquer thinner or ammonia. These solutions damage the acrylic surface.

You can use fine automotive acrylic rubbing and polishing compounds to remove fine scratches on acrylic. Always read the label before using any product.



NOTICE

Certain features described in this section may or may not apply to your particular model.

R - 1 WINTERIZATION**A. Prior to Lifting for Winter Lay-up**

1. Pump out the head (dockside discharge), and be sure the holding tank is empty. Flush the head holding tank with soap, water and a deodorizer (e.g., Lysol Liquid™). Add more water if necessary. Have the cleaning solution pumped out.
2. Have the fuel tank either full or completely empty. See the Engine Owner's manual for recommendations. Also, check with the dry dock operators for recommendations. If winter storing with a full fuel tank, gasoline winterizer such as Sta-bil® fuel conditioner, will reduce varnishing, condensation, etc.

NOTICE

If the fuel has been treated with winterizer, run engines for ten minutes to make sure the treated fuel is present in all lines and parts of the engines.

3. Drain water from the fresh water system.
4. Before winterizing the engine, flush out the system according to the specific engine owner's manual. The engine flush out should be used to clean the engine of unwanted salt, mud, sludge, etc. which may have accumulated in the engine cooling system.
5. Winterize the engine and drive systems as recommended in the engine owner's manual (applies to both gas and diesel systems). Portions of this winterization procedure may require that the boat be lifted. Winterization of engine and boat systems should be performed by qualified service personnel. **Note:** Repairs and replacement costs associated with frozen engine components are quite substantial.
6. If the boat is to be lifted or taken off a trailer, see Section P-7 - Hull Support in this manual for additional details.

B. After Lifting

1. Remove the drain plug.
2. Thoroughly wash the fiberglass exterior, especially the hull bottom. Remove as much marine growth as possible. Wax lightly.
3. Lower boat onto cradle properly or place boat on trailer (if applicable). Be sure boat is adequately supported. The boat should be raised slightly under the forward supports or trailer tongue to improve drainage to the transom drain.
4. Be sure all the water is completely drained from the fresh water system. Disconnect all hoses, check valves, etc. and blow all the water from the system using very low air pressure. The use of nontoxic, fresh water system antifreeze is recommended as an alternative to disassembling the water system. Refer to Section J-5 - System Maintenance in this manual for information on winterizing the water system.
5. Winterize the head (if equipped) as recommended by the head manufacturer. If the boat is equipped with a holding tank, mix some antifreeze solution and pour it into the head. Transfer some of the antifreeze to the holding tank by flushing the head. Also, refer to Section J-5 - System Maintenance for additional information.
6. Ensure that all water is removed from the sump pump, bilge pump and bilge pump lines. Dry the hull bilge, and self-bailing cockpit drain troughs. Water freezing in these areas could cause damage. See Section K-2 - Hull Drainage Systems.
7. Remove the batteries and store in a cool place. Clean the batteries using clear, clean water. Be sure the battery has sufficient water and clean terminals. Keep the batteries charged throughout the storage period. **DO NOT** store the batteries on a concrete floor or other damp or conductive surface.
8. Clean the boat interior thoroughly. Vacuum carpets, and dry clean drapes and upholstery jackets as necessary.
9. Wash exterior fiberglass components, wax lightly.

10. Clean exterior upholstery with hand dishwashing soap and water, rinse, and dry thoroughly.
11. Remove all oxidation from exterior hardware and apply a light film of moisture displacing lubricant.

C. Prior to Winter Storage

1. Remove as many cushions as possible. Remove storage lids or hatches. Open as many locker doors, as possible. Open the refrigerator door (if applicable). Leave these areas open to improve ventilation.
2. Spray the weather covers and the boat upholstery with Lysol Spray Disinfectant™. Applicable enclosed areas such as the refrigerator, shower basin, storage locker areas, etc. should also be sprayed with Lysol Disinfectant™.
3. Place small dishes of rodent poison such as D-Con™ in a number of areas around the boat. Be sure dishes are placed near the head and the engines, as rodents will destroy upholstery, water intake and discharge hoses.
4. If the boat will be in outside storage, properly support a storage cover and secure it over the boat. DO NOT secure the cover tightly to the boat. This does not allow adequate ventilation and can lead to dry rot. DO NOT store the boat in a damp storage enclosure. Excessive dampness can cause electrical problems, corrosion and dry rot.

 **WARNING**

*Placing an electric or fuel burning heating unit in the bilge of the boat during cold weather could cause fire or explosion and is **not** recommended.*

5. DO NOT use the bimini top or camper top as a winter storage cover. The life of these covers may be significantly shortened if exposed to harsh weather elements for long periods.

NOTICE

Boats stored outside in areas with heavy snow accumulation are more susceptible to damage, and should be inspected regularly during the winter months.

R - 2 GENERAL MAINTENANCE SCHEDULE

SERVICE	AT LAUNCH AND FIRST OPERATION*	25 HOUR CHECK EACH SEASON*	BI-SEASONALLY OR EVERY 6 MONTHS OR EVERY 100 HOURS*	SEASONALLY OR EVERY 12 MONTHS OR EVERY 200 HOURS*
Engine and Instrumentation	Refer to Section E			
Engine Maintenance	As Recommended by the Manufacturer			
Inspect Exhaust System Hoses and Connections				
Inspect Cooling System Hoses, Connections and Impellers				
Check Propellers				
Check All Thru-Hull Fittings				
Test Emergency Shut-Off Switch				
Gauge Cleaning				
Controls Systems	Refer to Section F			
Throttle and Shift Adjustment				
Neutral Safety Switch Test				
Cable and Control Lubrication				
Steering Systems	Refer to Section G			
Linkage and Connection Inspection				
Stern Drive Torque Tab Adjustment				
Power Steering Service	As Recommended by the Manufacturer			
Steering Adjustments				
Steering System Lubrication				
Electrical Systems	Refer to Section H			
Inspect Battery Connections				
Check Battery Water				
Battery Cable Inspection				
12 Volt Equipment Operation & Wiring Inspection				
Fuel System	Refer to Section I			
Inspect for Leaks				
Fuel Sender Inspection				
Fuel Filter Inspection				
Fuel Tank Inspection				
Water Systems	Refer to Section J			
Inspect All Water Systems				
Fresh & Holding Tank Inspections				
Drain & Flush Fresh Water System				
Drain & Flush Waste Water System				

* Or as Required

■ – Shaded areas indicate the time frame when service/inspection should be conducted.

SERVICE	AT LAUNCH AND FIRST OPERATION*	25 HOUR CHECK EACH SEASON*	BI-SEASONALLY OR EVERY 6 MONTHS OR EVERY 100 HOURS*	SEASONALLY OR EVERY 12 MONTHS OR EVERY 200 HOURS*
Ventilation and Drainage	Refer to Section K			
Engine Blower Operation	Before Every Use			
Head Blower Operation				
Blower Vent System Cleaning				
Bilge Pump Operation and Cleaning	Before Every Use			
Check Transom Drain Plug				
Interior Equipment	Refer to Section L			
Head Maintenance	As Recommended by the Manufacturer			
Thru-Hull Fitting Inspection				
Clean Cooler	As Required			
Exterior Equipment	Refer to Section M			
Check PFD's for Serviceability and Correct Number	As Required			
Check Charge of Fire Extinguishers	As Required			
Check Compass for Magnetic Deviation				
Check Trim Tab Fluid Level (if applicable)				
Check Trim Tab System for Leakage (if applicable)				
Clean Windshield	As Needed			
Upholstery	Refer to Section N			
Clean Upholstery				
Clean Carpet				
Spray Upholstery with Lysol				
Check Seat Hinges and Mounting Hardware				
Weather Covers	Refer to Section O			
Wash Weather Covers				
Spray Weather Covers with Lysol				

* Or as Required

■ – Shaded areas indicate the time frame when service/inspection should be conducted.

SERVICE	AT LAUNCH AND FIRST OPERATION*	25 HOUR CHECK EACH SEASON*	BI-SEASONALLY OR EVERY 6 MONTHS OR EVERY 100 HOURS*	SEASONALLY OR EVERY 12 MONTHS OR EVERY 200 HOURS*
Fiberglass Components and Hull	Refer to Section P			
Check All Fastenings (securing rails, seats, etc.)				
Clean Fiberglass Thoroughly				
Wax Hull Sides and All Non-Tread Areas				
Inspect Fiberglass Areas for Damage				
Perform Minor Touch-Up Repairs				
Sand Hull and Re-Apply Anti-Fouling Paint*				
Woodwork & Composite Maintenance	Refer to Section Q			
Clean Wood Trim	As Needed			
Clean Star Board	As Needed			
Clean Cockpit Tables	As Needed			
Clean Plexiglass Components	As Needed			
Trailers	Refer to Section S			
Wax Trailer				
Lubricate Trailer Jack				
Lubricate Trailer Coupler				
Lubricate Trailer Winch				
Brake Operation	Before Every Use			
Brake Inspection				
Inspect Hubs/Disc Brakes				
Inspect Bearings & Seals				
Lubricate Bearings				
Springs, Hangers & Suspension Parts				
Wheel Lug Nut				
Wheels				
Tire Pressure & Condition	Before Every Use			

* Or as Required

– Shaded areas indicate the time frame when service/inspection should be conducted.

S - 1 GENERAL TRAILER INFORMATION
NOTICE

Trailer models may vary. Please consult the trailer component manufacturer's information in your owner's packet for additional information.

The trailer must properly “match” the boat’s weight and hull design. Four Winns® F series trailers are designed specifically for the F series models only. Please consult our website at www.fourwinns.com or your Four Winns dealer for applicable trailer models. Four Winns® trailers meet or exceed the National Marine Manufacturers Association’s trailer requirements.

Four Winns manufactures bunk type trailers for the F series models only. The bunks are located specifically for Four Winns® boats and adequately support all parts of the boat. It is a “drive-on” type trailer which means winching the boat from the water is not necessary.

NOTICE

*When winching the boat onto the trailer, **be sure the bunks are wet to prevent damage to the boat or trailer.** DO NOT attempt to winch the boat forward when out of the water. Damage to the winch stand/assembly or tongue could occur.*

Four Winns offers both painted and galvanized trailers with GatorHyde™ protective coating. The painted trailer is intended to be used in fresh water and the galvanized trailer in salt/brackish water.

NOTICE

Four Winns does not recommend the usage of painted trailers for salt/brackish water conditions, as trailer life may be substantially reduced.

A. Regulations

Federal law requires that the trailer and tire registration information be compiled and recorded. The Four Winns® boat registration includes trailer registration information. A tire registration form, included in the owner’s packet, is to be filled out and returned to the tire manufacturer. Please see Section S-7 - “Supplemental Trailer Information” for additional information to assist you in completing the tire registration form.

NOTICE
Manufacturer’s Tire Registry

Ensure to fill out your name and address on the tire registration form provided in your owners packet. Mail it to the tire manufacturer for the purposes of compliance with Federal defect notification regulations.

Laws covering such items as trailer brakes, lights, safety chains, etc., will vary from state to state. Please contact the motor vehicle department in your state for additional information.

B. Load Carrying Capacity

The certification label shows the maximum load-carrying capacity and is located on the port forward side of the trailer. The Gross Vehicle Weight Rating (GVWR) is the load-carrying capacity plus the weight of the trailer itself. DO NOT exceed the GVWR rating for the trailer.

NOTICE

When using or choosing a tow vehicle with the correct GVWR, you must consider not only the weight of the boat and trailer but also the weight of the fuel, water, equipment, etc. Refer to Table 1 below:

EQUIPMENT	WEIGHT (AVERAGE)
Battery	60 Lbs./Battery
Fuel	6.5 Lbs./Gal.
Water	8 Lbs./Gal.
Accessories	150 Lbs. (Approximate)

Table 1: Average Equipment Weight

If selecting a trailer from another manufacturer, check the load-carrying capacity. A trailer with a load-carrying capacity that is too low will be unsafe on the highway and could cause sudden failure of critical trailer components or abnormal tire wear. A trailer with too high of a load-carrying capacity that is sprung for heavy loads can damage a lighter boat.

NOTICE

DO NOT overload your trailer by placing camping gear or other heavy equipment in the boat. DO NOT exceed the GVWR rating. Damage to the hitch, coupler, or trailer may occur.

For trailers, the steps to determining correct load limit are:

- (1) Locate the statement “The weight of cargo should never exceed the XXX kg or XXX lbs.” on your vehicle’s placard. See Figure S1.
- (2) This figure equals the available amount of cargo and luggage load capacity.
- (3) Determine the combined weight of luggage and cargo being loaded on the vehicle. That weight may not safely exceed the available cargo and luggage load capacity.



TIRE AND LOADING INFORMATION

Total load should never exceed
kgs. or lbs.

TIRE	SIZE	COLD TIRE PRESSURE	SEE OWNER'S MANUAL FOR ADDITIONAL INFORMATION
FRONT			
REAR			
SPARE			

Figure S1: Tire Label

Improper weight distribution can place excessive strain on the towing vehicle and trailer. It can also cause the trailer to “fishtail” (sway side to side). Be sure gear and other items are distributed evenly in the boat.

C. Hitches

The load-carrying capacity of trailer hitches will vary between manufacturers and must equal or exceed the GVWR. Four Winns® trailers use surge brake systems and require a fixed hitch. Refer to Section S-2D Surge Brakes for more information.

Before hitching the trailer to the vehicle, make sure the proper size hitch ball is installed to match the coupler. The ball size is determined by the Gross Ve-

hicle Weight Rating or GVWR. The GVWR is printed either on the trailer plate or embossed on the tongue, coupler or actuator. For trailers with a GVWR of 7000 pounds or less a 2” ball is used. For trailers with a GVWR over 7000 pounds a 2 5/16” ball is used. This information may also be obtained on our website at www.fourwinns.com. Refer to Section S-3 Operation for additional information on hitches. Also, consult your Four Winns dealer for his recommendation before purchasing a trailer hitch for your towing vehicle.



WARNING

*To help guard against a sudden failure while in use, **do not use a worn hitch ball**. Replace all worn or damaged parts.*

S - 2 TRAILER COMPONENTS

A. Bunk Supports

All bunk boards are made of pressure treated wood. This wood is rot resistant. All boards are covered with a high quality exterior grade carpet to protect the boat from damage during normal use.

Bunk supports run parallel to the keel and support the hull, extending beyond the transom. See Figure S2.

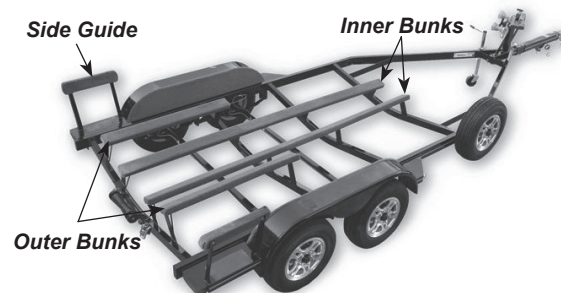

Figure S2: Trailer Bunks

Outer bunk supports provide stability for the boat. The inside bunks are the main weight bearing members. Side guide-on supports (certain models only) help to keep the boat straight while driving the boat onto the trailer. Keeping the tie-downs tightly fastened will prevent the boat from bouncing against the bunk supports.

NOTICE

Improper trailer setup can cause hull damage.

B. Tongue

Four Winns® trailers are designed with tongue weights between 5% and 10% of the total weight of the boat, fuel, gear and trailer. If the downward weight on the coupling ball does not fall within this range, coupler failure and towing instability may occur. If using another manufacturer's trailer, have the dealer check the tongue weight before trailering.

NOTICE

DO NOT use a bent or damaged tongue or coupler. Replacement parts may be ordered through a Four Winns dealer.

The trailer tongue is hinged or removable on our painted trailers and galvanized trailers. This allows for easier storage. The tongue is attached with clevis pin(s) with locking hair pin(s) or clevis pin keeper(s) to the trailer frame. Refer to Figure S3.

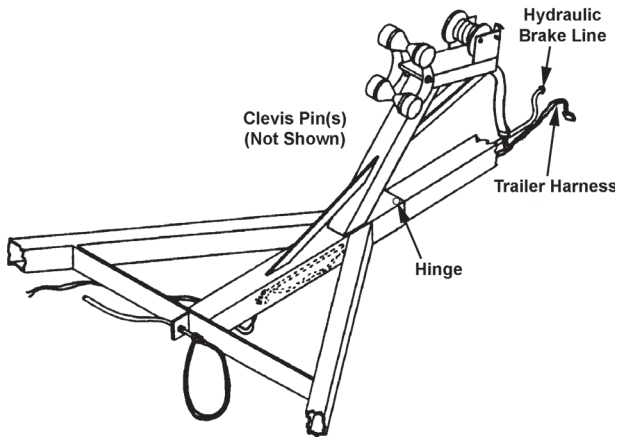

Figure S3: Trailer Tongue Assembly

To pivot the tongue on trailers models with exposed hinges:

1. Make sure the trailer jack is supporting the trailer load properly. Refer to Section S-2C on Swivel Jacks for additional information.
2. Disconnect the trailer from the tow vehicle.
3. Unplug the trailer's wire harness from the tow vehicle's trunk connector.
4. Remove the clevis pin keeper and clevis pin.

NOTICE

The tongue will exert some pressure on the clevis pins. It may be necessary to lift, push or wiggle the tongue to remove the clevis pins.

5. Pivot the tongue towards the trailer as far as it will go.

To reinstall, follow this procedure in reverse order.

1. Pivot the tongue until the clevis pin holes aligned.

NOTICE

When extending tongue ensure that the brake line and wire harness are not pinched. Failure to check could result in damage.

2. Insert clevis pin. **Always** be sure to insert clevis pin from the top and insert the clevis pin keeper.

NOTICE

The tongue will exert some pressure on the clevis pins. It may be necessary to lift, push or wiggle the tongue to insert the clevis pins.



CAUTION

Make sure the trailer tongue is secure before hitching to the towing vehicle.

4. If towing the trailer, remember to plug the 5-wire tongue harness to the trunk connector wire harness of your tow vehicle.

C. Swivel Jack

The jack is designed to lift, lower and support the tongues of the trailers when not connected to the towing vehicle. Before unhitching the trailer, use the following guidelines when setting up the jack.

1. Pull on the locking pin release. See Figure S4.

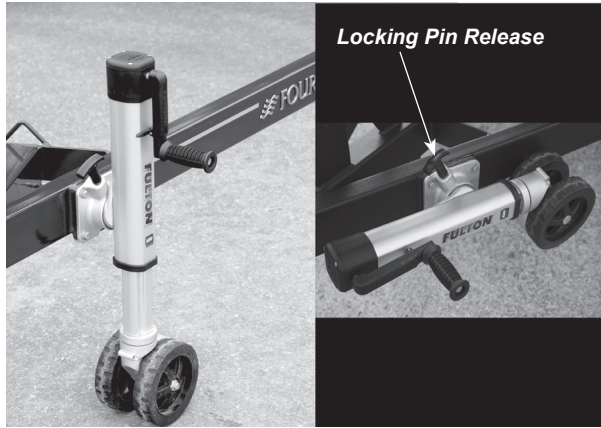

Figure S4: Swivel Jack

2. Swivel jack to the vertical position.
3. Release the locking pin release and make sure the pin fully engages to lock the swivel jack in place.

 **CAUTION**

Be sure dirt, sand, ice, etc., does not obstruct the proper seating of the lock pin.

4. When raising or lowering the jack, prevent the caster from rotating while cranking. Make sure the jack is planted on a firm and level surface before unhitching the trailer.

 **WARNING**

To prevent personal injury or damage to the boat and trailer, observe the following:

- *NEVER pull on the lock pin when any trailer weight is on the trailer jack.*
- *DO NOT move the trailer when resting on the swivel jack. Use towing vehicle to move the boat and trailer.*
- *Keep body and feet clear of trailer tongue when raising or lowering jack.*

Always remember to swivel jack to the horizontal position before towing the trailer. Damage to the caster and jack may result.

The swivel jack provided on the certain Four Winns® trailer can be removed from the trailer to allow for maintenance or repairs. Follow the manufacturer's recommendations provided in the owner's packet.

D. Surge Brakes & Coupling Assembly

Surge brakes are standard on the F series model trailers manufactured by Four Winns. Surge brakes operate automatically when the tow vehicle's brakes are applied. When the tow vehicle slows down or stops, the forward momentum or "surge" of the trailer against the hitch ball applies pressure to a master cylinder in the trailer coupler. The master cylinder supplies hydraulic pressure through the hydraulic system which activates the trailer's disc brakes. See Figure S5. Please refer to the manufacturer's literature included in your owner's packet for further details regarding operation and maintenance.

To hitch the trailer to the tow vehicle, place the coupler latch in the open position to unlock the coupler. See Figure S5. Push down on the coupler latch to lock the trailer to the ball hitch. Push coupler latch lever back until the latch engages and is properly seated. The safety pin, provided with the trailer, or a padlock **must be inserted completely** in the forward coupler latch hole. See Figure S6. This helps ensure the coupler's latch remains in the locked position during towing of the trailer. Refer to Section S-3 Operation for additional information on couplers and hitching to the tow vehicle.

NOTICE

Anti-sway devices as used on recreational vehicles (RV's) are not applicable to surge brake systems and should not be used on Four Winns® trailers.

DO NOT use a trailer hitch with moving parts. The brakes could activate when traveling downhill. Always use a fixed hitch.

Release handle must be in open position to remove from or place on ball.

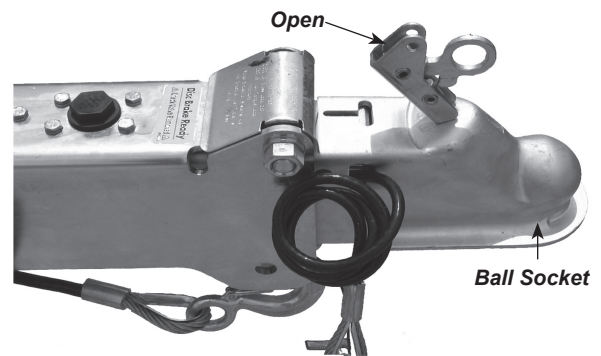

Figure S5: Brake Actuator & Coupling Assembly - Open
(Coupler may vary depending on Boat/Trailer Model)

Release handle must be fully closed and pin inserted before towing.

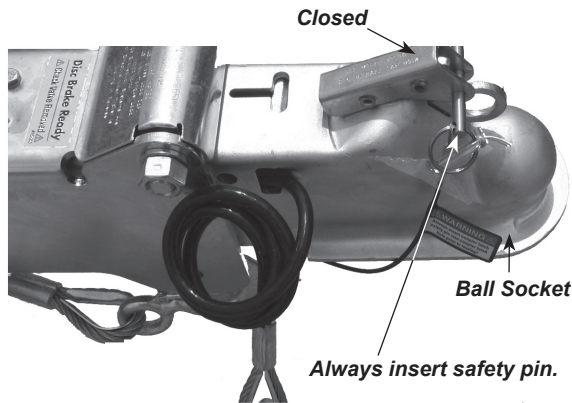

Figure S6: Brake Actuator & Coupling Assembly - Closed
(Coupler may vary depending on Boat/Trailer Model)

The brake actuator and coupling assembly comes with a 5-wire plug for connecting to the tow vehicle's trailering harness. Figure S7 depicts the 5-wire plug, the color of the individual wires, and the designated circuit for each wire.

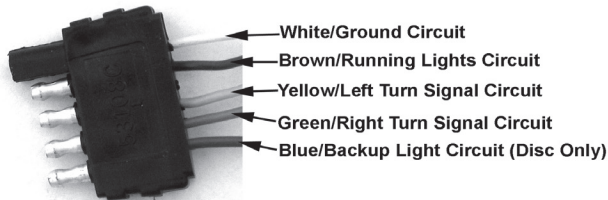

Figure S7: 5-Wire Plug Harness

For maintenance and other information, refer to the manufacturer's literature included with in the owner's packet.

E. Winch

Winch operating instructions are listed below.

To release the winch, place the ratchet in the REVERSE or NEUTRAL position. The winch handle may spin when pulling on the winch line.

CAUTION

To prevent personal injury, observe the following:

A spinning winch handle can cause injury. Be sure the area is clear.

DO NOT release the handle when the ratchet is disengaged. Be sure the ratchet is engaged or no load is on the winch before releasing the handle.

CAUTION

To prevent personal injury, ALWAYS inspect the winch line and hook before each use. NEVER use line that is worn or frayed. NEVER let anyone stand in or behind a boat while pulling with the winch.

To rewind the winch, ALWAYS engage the ratchet first. Turn the handle in the appropriate direction to rewind the line.

CAUTION

A clicking sound will be heard when the winch is properly engaged. If a clicking sound is not heard, DO NOT release the handle. Handle may spin backwards. Lower the load into a safe position before releasing the handle.

Refer to the manufacturer's literature, included in the owner's packet, for more information on winch operation.

F. Tires & Wheels

Trailer wheel rims are available in three types of finishes: white, aluminum and galvanized. The white, powder coat finish is standard. Aluminum rims (Mags) are optional on painted trailers. Galvanized trailers are equipped with matching galvanized rims. Spare tire covers may be available as an option and will match the trailer. Check with your Four Winns Dealer for availability.

The tires installed on Four Winns® trailers meet the trailer load requirements for each model. Before trailering, make sure the tires are inflated according to the manufacturer's recommendation. Tire pressure information is noted on the tire and in the manufacturer's

literature included in the owner's packet. Also refer to Section S-7 - "Supplemental Trailer Information" for additional information.

Mag wheels include a locking-type nut to help deter theft. This nut requires a special key or socket to remove. The socket will be included with your trailer when mag wheels are ordered. Refer to Figure S8.

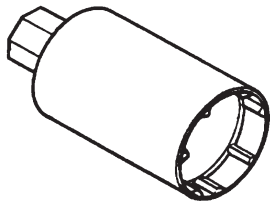

Figure S8: Mag Wheels & Mag Wheel Key (Socket)

NOTICE

DO NOT use an air wrench or other power equipment to install lug nuts on aluminum (Mag) wheels. Damage to the wheel may result. Lug nuts should be torqued to 85 foot pounds.

Examine the tires frequently for snags, bulges, excessive tread wear, separations or cuts. Refer to the manufacturer's literature included in the owner's packet for more information.

NOTICE

The warranty of the tire is administered by the manufacturer of the tire. Contact the tire manufacturer regarding any warranty concerns relating to your tires.

G. Spare Tire Carrier

Spare tires are optional on all Four Winns® trailers. A spare tire carrier is bolted to the trailer frame and is available in painted or galvanized finish. A spare tire carrier and wheel can be ordered from your Four Winns dealer. Refer to Figure S9.

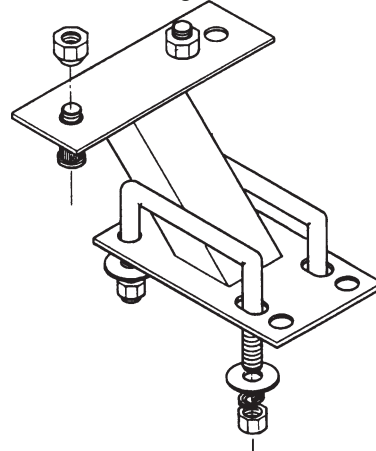

Figure S9: Spare Tire Carrier

H. Lights

Four Winns® trailers are equipped with taillights, brake lights, turning signals, and clearance lights. All lights are sealed to prevent moisture from entering. The taillight assemblies may be replaced. The LEDs of the taillight are also enclosed in a sealed housing which should not be opened. See Figure S10. Contact your Four Winns dealer for assistance should replacement be necessary.



Figure S10: Tail Light - LED

NOTICE

Use a heavy duty turning signal flasher on towing vehicles. Check with your local auto parts store or ask your Four Winns dealer for assistance.

Consult your dealer for state trailer regulations concerning lighting and other optional equipment.

I. Tie-downs

The boat should be secured to the trailer by tie-downs to prevent damage to the hull. The boat may shift or bounce against the bunks or hull supports if not secured. It may also slide or fall off the trailer while being towed.

There are two types of tie-downs being used:

1. **Bow Tie-downs:** A bow stop to hold the front of your boat in place is located on the winch stand. It should be positioned so that the winch line pulls straight and is parallel to the trailer frame. A separate tie-down should then be attached to hold the boat. See Figure S11.

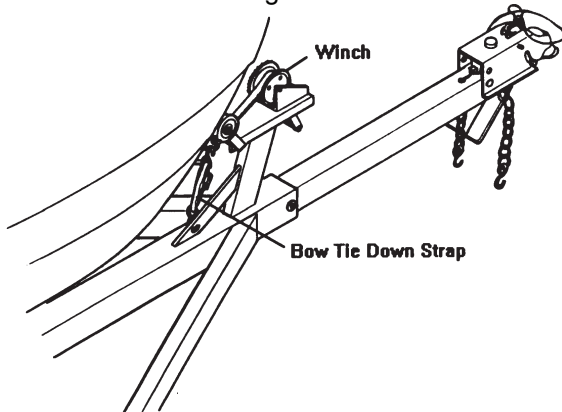

Figure S11: Bow Tie Down Strap

NOTICE

DO NOT rely on the winch cable (or line) alone to hold the bow of the boat against the bow stop. A bow tie-down is provided with the Four Winns® trailer.

2. **Rear Tie-downs:** It is very important that the transom is resting securely on the bunk supports at the rear of the trailer. Rear tie-downs are attached to the trailer and used to secure the boat to the trailer. Tighten the tie-downs to prevent the boat from moving. See Figure S12.



Figure S12: Rear Tie Down Straps

The **bow tie-down** is a mechanical ratchet device. To allow the strap out, follow the procedures below:

1. Place two fingers on spring-loaded release, and pull release away from spindle/gear.
2. Open tie-down to a flat, 180° position.

NOTICE

Spring-loaded release should click into a notch on the handle. Both spring releases should clear the inner gear.

3. Pull strap out. The inner spindle/gear should move freely.

To ratchet strap or tighten down the strap on the boat:

1. Place two fingers on spring-loaded release, and pull release away from spindle/gear.
2. Bring both handles together. Both handles should ride on the inner gear.

3. Open (to approximately 110°) and close handles to ratchet. Leave in closed position to maintain pressure on strap.

The **rear tie-down straps** are also a mechanical ratchet devices. To allow the strap out, follow the procedures below:

1. Place two fingers on spring-loaded release and push release downward while pushing the handle forward towards the trailer. See Figure S13.



Figure S13: Rear Tie Down Strap - Release

2. With other hand, pull strap upward. The inner spindle/gear should move freely.

To ratchet strap or tighten down the strap on the boat:

1. Place hand on handle and lift upward and away from trailer until the spindle/gear locks and handle stops.
2. Return handle to start position and repeat step one. Continue until strap has been sufficiently tightened. See Figure S14.

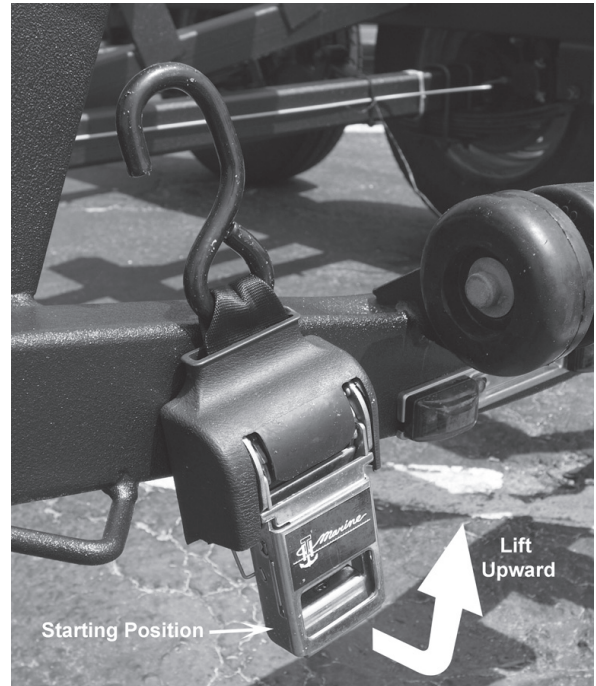

Figure S14: Rear Tie Down Strap - Tightening

S - 3 OPERATION

A. Hitching Trailer

Before towing, the trailer must be properly hitched to the tow vehicle.

WARNING

To ensure proper engagement of the actuator's coupler to the tow ball, **DO NOT** use a multi-piece ball, an incorrectly sized ball, or a worn/damaged ball. Please refer to the trailer's certification plate, coupler or actuator on the trailer for Gross Vehicle Weight Rating (GVWR) or visit our website at www.fourwinns.com. Trailers with a GVWR of 7000 pounds or below require a 2" tow ball and trailers above a GVWR of 7000 pounds require a 2 5/16" tow ball.

1. Position actuator ball socket above ball hitch.
2. Open the coupler latch fully to allow the ball latch to rotate open. Note: You will have to remove the safety pin from the coupler latch hole to fully extend the coupler latch. The coupler latch will remain up to indicate that it is not yet attached to the ball. See Figures S5 & S6.

- Lower trailer tongue until ball is seated or rests in ball socket. Ensure the ball latch is in the correct position to retain the hitch ball.
- Close coupler latch by pushing latch down until latch engages properly.

The coupler latch should close and secure freely with finger pressure when ball is properly seated in the ball socket. **If the coupler latch does not close freely or does not engage properly, do not tow trailer. DO NOT** force the coupler latch into closed position, otherwise damage could result. Inspect actuator for bent parts or cause of improper operation.

NOTICE

Keep the coupler clean and lubricated to prevent damage to the coupler.

- Make sure the actuator is secure. If unsure, extend the trailer tongue jack to the ground and lift (with the jack) the car and trailer combination approximately 2" to 4". If the ball does not disengage and remains secured, the actuator is latched properly.

NOTICE

To prevent back injury, DO NOT physically lift the trailer tongue when loaded.

- The safety pin, provided with the trailer, or a padlock **must be inserted completely** in the coupler latch hole. This ensures the coupler's locking latch remains in the locked position during towing of the trailer. Use of a padlock will help to deter theft.
- Connect actuator break-away cable S-hook securely to one of the tow vehicle hitch's safety chain connection points. Do not connect S-hook to the safety cables or chains. The cable should hang clear of trailer tongue and be long enough to permit short radius turns without pulling the break-away cable. **DO NOT** loop the break-away cable around a bracket and loop it back onto itself.
- If the break-away system is accidentally applied while unhitching, insert a flat-bladed screwdriver into the slot of the break-away catch hole under the actuator and pry down to release. See Figure S15.

Flat-Bladed Screw Driver

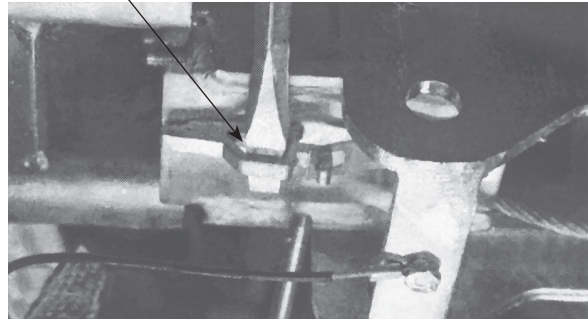



Figure S15: Emergency Break-Away System - Manual Release

 **WARNING**

When resetting the break-away system keep hands and fingers clear as you reset the mechanism. Hydraulic pressure held in the system may cause the assembly to snap back suddenly.

 **CAUTION**

The break-away system is not designed to operate if the trailer does not separate completely from the tow vehicle, or if the trailer tongue "submarines" and goes beneath the tow vehicle. DO NOT use break-away cable as a parking brake.

- Safety cables are provided and must be used. Cross the safety cables under the coupling and attach to the towing vehicle's frame or bumper. See Figure S16. Always allow slack for turns. Regulations vary from state to state. Please check the local laws in your state.

 **WARNING**

*The trailer's safety cable length MUST be set short enough so the actuator's break-away cable is NOT pulled if the coupler separates from the tow vehicle's hitch but remains connected by the safety cables. The break-away system should only be activated after BOTH the trailer's coupler and safety cables have failed and allowed the trailer to completely separate from the tow vehicle. Provide just enough slack in the trailer safety cables to allow short radius turns. The cables should not drag on the ground. **Safety cables must be used.***

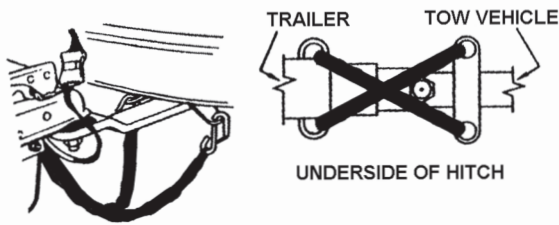

Figure S16: Crossing the Safety Cables

WARNING

To reduce the risk of break-away accidents, be sure coupler is seated and safety cables are crisscrossed before trailering.

10. Retract jack fully and place in trailering/horizontal position.
11. Check for proper tow vehicle-trailer hookup. The tow vehicle and trailer should be level with a positive tongue load. Four Winns® trailers are designed with tongue weights between 5% and 10% of the total weight of the boat, fuel, gear and trailer. The trailer should be close to level. If unsure of tongue load and trailer position, consult your Four Winns dealer before proceeding.

WARNING

Be sure the tow vehicle and trailer are level and have a positive tongue load. This will allow the brake actuators to function properly on trailer models having such braking systems.

Be sure to read the manufacturer's literature, included in the owner's packet, before towing your Four Winns® boat and trailer.

B. Backing Up With Surge Brakes

Follow the steps listed above for hitching the trailer before backing up.

1. Before backing up a slope or through soft ground, pull the trailer forward slightly to assure the actuator socket is in the fully forward position.
2. Back the trailer up.

CAUTION

Avoid sharp turns. This could bend, create extreme stress or fracture either the actuator or trailer tongue.

NOTICE

Be sure to check for obstacles or persons behind the trailer before backing up. Also, adjust your mirrors for clear view of the area behind the trailer.

3. If the trailer is to be uncoupled from the tow vehicle after backing, block all trailer wheels and pull forward slightly to take strain off the actuator. Uncouple the actuator by lifting the release handle and raise the trailer tongue with the jack.

For most trailering conditions, the brake actuator will allow you to back up normally using a 5-wire harness connector. However, if the coupler is not wired or if there is a failure the trailer can still be backed up by using the manual brake lockout.

To use your lockout, check that no force is being applied to the actuator. This is achieved by positioning the towing vehicle and the trailer on a flat service, or with the trailer downhill from the tow vehicle. Set the vehicle's parking brake.

Insert a 5" x 7/16" bolt or screwdriver into the reverse lockout position hole (upper hole on side of actuator). This will then block movement of the actuator. See Figure S17. Reverse lockout option must only be used when moving in reverse and when braking is not required. Immediately remove bolt or screwdriver prior to towing after backing up is completed.

NOTICE

The reverse lockout position hole and actuator hole may not be in alignment. You may have to block the trailer's wheels and pull the trailer forward enough so the holes are aligned and a bolt or screwdriver may be inserted completely into the reverse lockout position holes.

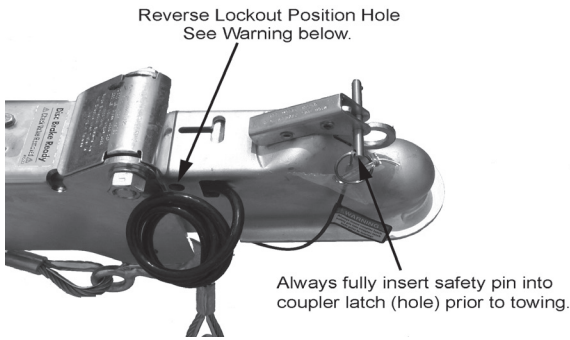

Figure S17: Reverse Manual Brake Lockout

WARNING

Never allow the bolt or screwdriver to remain in the reverse lockout position hole. After reverse maneuvering, always remove bolt or screwdriver from the reverse lockout position hole. Failure to remove bolt or screwdriver from reverse lockout position hole will prevent forward movement braking which can result in serious property damage, injury or death.

NOTICE

Trailer components may be different between models and may change during the model year. Be sure to read all manufacturer's literature supplied with your Four Winns® trailer.

S - 4 TRAILERING

A. Checklist

Before trailering, the trailer should be inspected for the following:

1. Check tires for proper inflation. Under-inflated tires heat up rapidly and may blowout or cause uncontrolled swaying.
2. Check lug nuts for proper tightness.
3. Be sure the coupler is secured to the trailer hitch and safety cables are attached.
4. Be sure trailer taillights and turning signals are operational.
5. Check the brakes for proper operation prior to departure.

6. Check tie-downs and make sure boat is secured to the trailer.
7. Check the springs and under carriage for loose parts.
8. Before towing, close and secure all hatches, doors, and windows. Securely store all equipment and canvas. Installed tops, side curtains, and aft curtains can be damaged while towing.
9. Carry a spare tire for both the trailer and towing vehicle. On extended trips, carry spare wheel bearings, seals, and races. Be sure and carry the proper tools to complete the repairs.

WARNING

To avoid bearing failure and possible wheel loss, keep wheel bearings properly lubricated. Inspect the wheel bearings periodically and check for damage.

10. Before trailering, inspect the bearings for wear and adequate lubrication. When traveling, check the wheel hubs during stops at gas stations, restaurants or other places. If the hub feels abnormally hot, the bearing should be inspected before continuing the trip.

B. Tactics

NOTICE

Be sure to check the towing vehicle manufacturer's literature for recommendations on towing.

1. Install outside rear view mirrors on both sides of the towing vehicle to improve vision. Check the rear view mirrors at frequent intervals to be sure trailer and boat are riding smoothly.
2. Allow at least one car and trailer length between vehicles for each 10 mph. **DO NOT** tailgate.
3. Use low gear (on manual transmissions) when traveling up steep hills or over sand, gravel, or dirt roads.

4. Use care if shifting to a lower gear while traveling downhill. This could activate the trailer's surge brakes for the duration of the downhill run and cause overheating. Extended overheating could result in complete loss of the trailer brakes.

To help prevent overheating, slow down while approaching the crest of a hill and maintain a slow, controlled downhill speed. Apply brakes in short intervals to allow time between braking for the brakes to cool off.

**CAUTION**

In mountain regions, extra care is required due to extreme braking conditions. If not equipped with a "rugged duty towing package" use turnouts often to allow brakes to cool otherwise loss of trailer brakes could result. Consult with your Four Winns dealer regarding a "rugged duty towing package" for your towing requirements.

5. When rounding turns on highways or streets, DO NOT cut corners. Also, travel slowly over railroad tracks.
6. If the trailer begins to "fishtail" when accelerating, reduce speed until it ceases. If the trailer "fishtails" again during acceleration, stop to investigate the cause of the problem. Check for improper trailer load and uneven weight distribution inside the boat. Check the winch line and tie-downs. Also check the tires for proper inflation or damage. If necessary, redistribute the load before continuing.

For additional information on trailering, refer to the "Boating Basics" manual included in the owner's packet.

S - 5 MAINTENANCE

A. Care of Exterior Finish

When using the trailer, keep in mind the paint can scratch and become marred during normal use. In most cases, touch-up paint can be ordered. Please contact a Four Winns dealer for assistance.

Some maintenance is required to maintain the finish and minimize rusting. The trailer should be washed and rinsed with clean water immediately after each use. Depending upon use, waxing is recommended

twice a year. Use paste wax designed for enamel paint.

On galvanized trailers with GatorHyde™, rinse all exposed metal parts thoroughly with only clean water after use. The GatorHyde™ protective coating may be cleaned with mild dishwashing soap in a bucket of water along with a nylon boat brush. Rinse thoroughly with clean water.

To rejuvenate as well as UV protect worn and faded GatorHyde™ you may purchase a product called GatorGloss™. To place an order you can phone Elastomer Specialties, Inc. at 918-485-2835 or Fax 918-485-2856.

B. Bunks

The bunks should be replaced if they are cracked, warped, or evidence of dry-rot is found. The replacement boards should be treated lumber of the same length and width. Re-carpet bunks with high quality exterior grade carpet.

**CAUTION**

*DO NOT burn damaged or broken bunks
Toxic fumes will be released. Dispose of
bunks properly.*

C. Swivel Jack

Keep the swivel jack clean of dirt, tar, and mud. Lubricate every six months. The swivel jack's inner ram should be lubricated with SAE 30 weight oil. The top cover may be removed to lubricate the gears with wheel bearing grease.

Replace all worn and damaged parts. ALWAYS use the manufacturer's replacement parts. Replacement parts may be ordered through your Four Winns dealer.

For more information on maintenance, refer to the manufacturer's literature included in the owner's packet.

D. Brake Actuator & Coupling Assembly

When storing or parking your trailer, keep the brake actuator and coupling assembly (coupler) off the ground to prevent dirt buildup in the ball socket. Keep the coupler clean of dirt, tar, and mud. Lubricate the coupler with SAE 30 weight oil every six months or as

often as necessary. Replace any worn or defective parts. If the coupler is damaged, contact your Four Winns dealer for replacement parts. DO NOT use a damaged or bent coupler assembly.

For more information on maintenance, refer to the manufacturer's literature included in the owner's packet.

NOTICE

The trailer should be set up at a slight angle to allow for water to drain aft in the boat.

E. Winch

The winch should be kept clean of dirt, ice, paint, etc., and the spur gears should have a film of grease on them at all times. Apply several drops of SAE 30 weight oil to the ratchet pawl mechanism, bushings and pinion shaft threads twice per season.

Replace any worn or damaged parts. For more information on maintenance, refer to the manufacturer's literature included in the owner's packet.

F. Lights

Inspect wiring for cuts or bare wire which could cause electrical shorts. Repair or replace defective wiring. Replace cracked or damaged lens and always carry spare bulbs. Replacement parts may be ordered through a Four Winns dealer.

G. Tie-downs

Replace frayed or damaged tie-downs. Periodically, lubricate the ratchet mechanism with a fine oil or silicone spray. Replacement parts may be ordered through a Four Winns dealer.

H. Wheels

Some maintenance is required to maintain the finish and retard rusting of painted rims. The wheels should be cleaned with dishwashing soap and water and rinsed with clean water immediately after each use. Waxing is recommended three to four times each year.

Aluminum wheel rims may be cleaned with dishwashing soap and water. Also, there are cleaning products specifically for aluminum that can be used. Cleaners may be obtained from Four Winns deal-

ers and your local auto parts stores. The Mag wheel manufacturer recommends a product by Priority One® called Pro-Long Aluminum/Chrome Wheel Protectant™. Galvanized rims should be rinsed only with clean water immediately after each use.

NOTICE

ALWAYS read the manufacturer's instructions on the label before using any product.

I. Brakes

Keep the actuator clean of dirt, tar, and mud. The actuator and internal parts should be lubricated at all times with SAE 30 weight oil. The hitch ball may be lubricated with automotive grease or lubricant made for hitch balls.

Periodically inspect the brake system for leaks. Check all hoses for cuts or wear. Replace all defective hoses. The master cylinder should be filled within 1/2 inch from the top of the reservoir.

At the beginning of each year, inspect the brakes for excessive wear, have linings replaced if necessary.

If the brakes need bleeding, consult your Four Winns dealer for assistance. If unavailable, a brake or auto repair facility can perform the repair.

Refer to the manufacturer's literature included in the owner's packet for additional information on the brake system.

J. Bearings

Wheel bearings and seals should be inspected at the same time as brakes. Have worn or defective parts replaced.

Four Winns uses the Turbo Lube oil bath lubrication system on F series model trailers. The Turbo Lube design rotates individual roller bearings through oil multiple times per wheel revolution. This system keeps your hub and bearings cooler, reduces wear and increases tow vehicle mileage. The Turbo Lube system is submersible. With the Turbo Lube system the need to disassemble hubs and repack the wheel bearings is eliminated. See Figure S18.



Figure S18: Turbo Lube Hub - Front Fill Model

Turbo Lube Hub Bearing Lubrication System Maintenance for Front Fill models:

1. Remove oil filling plug from Turbo Lube cap. Add oil into the Turbo Lube hub. See Figure S19.

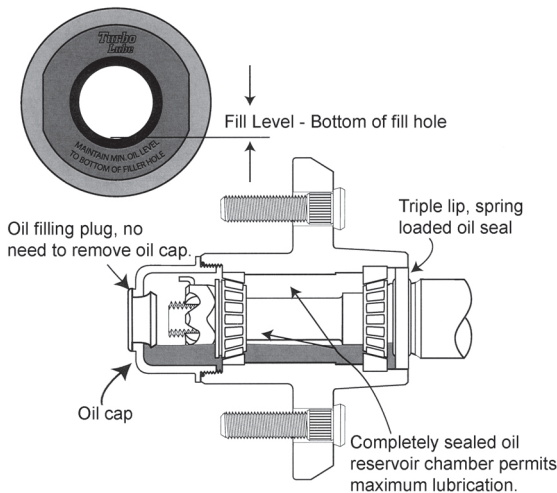

Figure S19: Turbo Lube Oil Fill Diagram

2. Add oil until oil level is just below the filler hole. Some time should be given to allow oil to pass through the bearings and level off.
3. Replace oil filling plug.
4. Check oil level. Add oil if necessary (repeating step 1, 2 & 3).
5. Check oil level in the Turbo Lube Hub before each trip. Add oil if required to the bottom of the filler hole on cap.

Note: The recommended oil change period is 50,000 miles or every two years. When changing or adding oil, the recommended oil is a 50w synthetic preferably and any quality brand oil is acceptable. The acceptable oil weight range that may be used is 50w Oil (minimum to 90 Weight Gear (maximum).

Note: It is normal for the oil to change color after a few miles of use. Even a small amount of moisture condensation can cause the oil to turn milky.

NOTICE

Most bearing failures are due to improper maintenance. Be sure to inspect bearings and seals as noted in Section S-6B and refer to the manufacturer's literature included with your trailer.

S - 6 AXLE INSPECTION & REPAIRS

As a general rule, repairs and maintenance should be performed by qualified servicing personnel. Our axle manufacturer recommends that a certified mechanic should be consulted on the following items:

1. Broken axle
2. Broken spring
3. Worn spring eye bushing parts
4. Sagging springs
5. Welding fatigue
6. Serious leakage of seal
7. Tire wear
8. Loose or worn suspension parts
9. All brake related adjustments, inspections and problems

A. Removal of Hub

The following instructions pertain only to trailers manufactured by Four Winns. To remove the hub to inspect the bearings and seals, refer to Figure S20 and the following instructions:

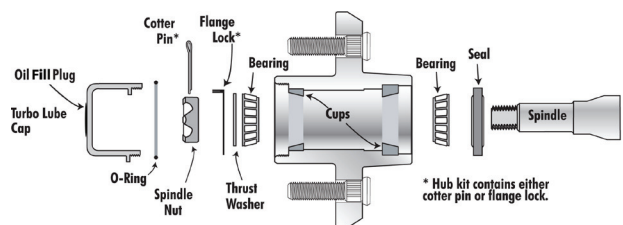

Figure S20: Axle Components

1. Remove lug nuts.
2. Remove wheel.
3. Remove Turbo Lube cap.
4. Remove cotter pin or flange lock.
5. Unscrew the spindle nut counterclockwise.
6. Remove thrust washer.
7. Remove hub from spindle.

B. Bearing/Seal Inspection and Replacement

When inspecting bearings or seals:

1. Inspect the grease seal for damage, tears, or cracks. If there is no damage or leakage is not occurring, the seal is in good condition.

If the seal is torn or cracked, then it should be replaced. The seal can be pried out of the hub with a screw driver. Be sure to replace the seal using the recommended replacement parts. Parts can be obtained from your Four Winns dealer.

2. When inspecting the bearing, check for corrosion and wear. If any rust or wear exists on the bearing, then remove and replace with the manufacturer's recommended part.
3. If the bearings are in good condition, repacking the grease should be done at this time. Hand pack each bearing individually using a premium water-resistant wheel bearing grease.

C. Hub Reinstallation

1. To reinstall hub, reverse the procedures listed above.
2. It is important to tighten the spindle nut to approximately 50 ft.-lbs. (12" wrench with full hand force). Loosen the nut then finger tighten.
3. Replace the cotter.
4. When reinstalling wheel, the following tightening procedure is recommended by the manufacturer:
 - a. Place wheel lug nuts on by hand to start.

- b. Tighten initially to 15 - 20 ft. lbs. (Apply 20 pounds of pressure to wrench 12" long) using cross tightening sequence. Proceed to finish tightening to 85 ft. lbs. (Applying 85 pounds of pressure to wrench 12" long will yield 85 ft. lbs. of torque).
- c. Re-torque after first 50 miles of use.

Refer to Sections S-2F and the S-7 for additional information.

S - 7 SUPPLEMENTAL TRAILER INFORMATION

A. Information Contained on Sidewall of the Tire

Both U.S. and Canada Federal regulations require tire manufacturers to place standardized information on the sidewall of all tires. This information identifies and describes the characteristics of the tire. See Figure S21.

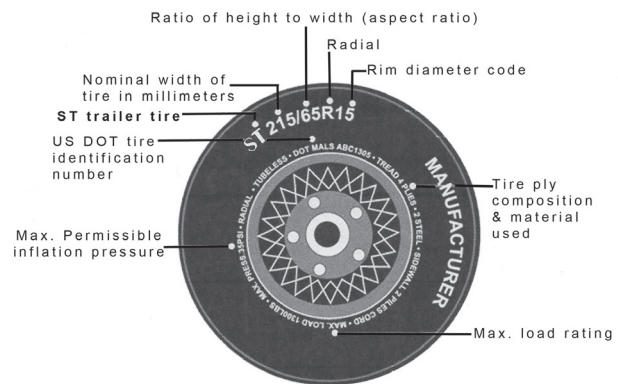

Figure S21: Axle Components

Maximum Permissible Inflation Pressure: Indicates the tire manufacturer's maximum permissible pressure and/or the pressure at which the maximum load can be carried by the tire. Refer to the Certification Label on the port forward half of the trailer for the correct tire pressure for your trailer.

U.S. DOT Tire Identification Number (TIN): This begins with the letters 'DOT' and indicates the tire meets all federal standards. The next two numbers or letters are the plant code designating where it was manufactured, the next two are the tire size code, and the last four numbers represent the week and year the tire was built. For example, the numbers 5110 mean the tire was built the 51st week of 2010. The numbers are identification codes used for traceability. This information is used to contact customers if a tire defect requires a recall.

ST: Indicates the tire is a special tire for trailers in highway service.

215: Indicates the nominal width of the tire in millimeters from sidewall edge to sidewall edge. In general, the larger the number, the wider the tire will be.

65: Indicates the aspect ratio which gives the tire's ratio of height to width.

R: Indicates a "radial" type tire.

15: Indicates the wheel or rim diameter in inches.

Tire Ply Composition and Materials Used: Indicates the number of plies or the number of rubber-coated fabric in the tire tread and sidewall. Tire manufacturers also must indicate the ply materials in the tire and the sidewall, which include steel nylon, polyester, and others.

Maximum Load Rating: Indicates the maximum load in kilograms and pounds that can be carried by the tire. Refer to the Certification Label on the port forward half of the trailer for the correct tire pressure for your trailer.

B. Sample Tire Registration

NOTICE:
Manufacturer's Tire Registry: Be sure to fill out the tire registration form provided with your owner's packet. Mail it to the tire manufacturer for the purpose of Federal Defect Notification Regulations. See Figure S22.

8-193 (1-05)
791-100-298

IMPORTANT

In case of a recall, we can reach you only if we have your name and address. You **MUST** send in this card to be on recall list.
Do it today.

SHADED AREAS MUST BE FILLED IN BY SELLER

CUSTOMER'S NAME (PLEASE PRINT)	QTY	TIRE IDENTIFICATION NUMBER																
		1	2	3	4	5	6	7	8	9	10	11	12	13				
CUSTOMER'S ADDRESS																		
CITY STATE ZIP CODE																		
NAME OF DEALER WHICH SOLD TIRE																		
DEALER'S ADDRESS																		
CITY STATE ZIP CODE																		
DEALER NON-SIG #																		

889040061

Figure S22: Sample Tire Registration Form

C. Inflating Your Tires

Safe operation of your trailer requires that your tires are properly inflated. Remember that a tire can lose up to half of its air pressure without appearing flat. Before each trip, check your tires with a tire gauge, including the spare (if equipped). Inflate all tires to the inflation pressure recommended on the Tire Label and/or on the Certification Label located on the port side of the forward half of the trailer. See Figures S23 & S24. Failure to follow the tire pressure recommendations can cause uneven treadwear patterns and adversely affect the way your trailer handles.



TIRE AND LOADING INFORMATION

Total load should never exceed
kgs. or lbs.

TIRE	SIZE	COLD TIRE PRESSURE	SEE OWNER'S MANUAL FOR ADDITIONAL INFORMATION
FRONT			
REAR			
SPARE			

Figure S23: Tire Label

Labels located on the port side of the forward half of the trailer.

MANUFACTURED BY / FABRIQUE PAR:		DATE:	
GVRW / PNBV	KG (LB)	TIRES / PNEU	
GAWR(EACH AXLE) / PNBE (CHAQUE ESSIEU)	KG (LB)		
RIMS / JANTE	LOAD CAPACITY	KG(LB)	
COLD INFL. PRESS. / PRESS. DE GONFL. A FROID	KPA(PSI / LPC)	<input type="checkbox"/> SINGLE <input type="checkbox"/> DUAL

THIS VEHICLE CONFORMS TO ALL APPLICABLE U.S. FEDERAL MOTOR VEHICLE SAFETY STANDARDS IN EFFECT ON THE DATE OF MANUFACTURE SHOWN ABOVE.
 THIS VEHICLE CONFORMS TO ALL APPLICABLE STANDARDS PRESCRIBED UNDER THE CANADIAN MOTOR VEHICLE SAFETY REGULATIONS IN EFFECT ON THE DATE OF MANUFACTURE. - CE VEHICULE EST CONFORME A TOUTES LES NORMES QUI LUI SONT APPLICABLES EN VERTU DU REGLEMENT SUR LA SECURITE DES VEHICULES AUTOMOBILES DU CANADA EN VIGUEUR A LA DATE DE SA FABRICATION.

V.I.N. / N.I.V. TYPE / TYPE: TRAILER TRA / REM

Figure S24: Certification Label

When weather temperature changes occur, tire inflation pressures also change. A 10° F (6° C) temperature drop can cause a corresponding drop of 1 psi (7 kPa) in inflation pressure.

NOTICE:

Under-inflation is the most common cause of tire failures and may result in severe tire cracking, tread separation or “blowout”, with unexpected loss of vehicle control and increased risk of injury. Under-inflation increases sidewall flexing and rolling resistance, resulting in heat buildup and internal damage to the tire. It also may result in unnecessary tire stress, irregular wear, loss of vehicle control and accidents. A tire can lose up to half its air pressure and not appear flat!

To check the pressure in your tire(s):

- 1: Check your tire(s) when they are “cold”. The term cold does not relate to the outside temperature. Rather, a cold tire is one that has not been driven for at least three hours. When you drive, your tires get warmer, causing the air pressure to increase. Therefore, to get an accurate tire pressure reading, you must measure the tire pressure when the tires are cold or compensate for the extra pressure in warm tires.
- 2: Remove the cap from the valve on one tire, then firmly press the tire gauge onto the valve and measure the pressure with the tire gauge.
- 3: Add (or remove) enough air to reach the recommended air pressure indicated on your Certification Label and or Tire Label. See Figures S23-S25.



TIRE AND LOADING INFORMATION

Total load should never exceed
1719 kgs or 3790 lbs.

ORIGINAL TIRE SIZE		COLD TIRE PRESSURE	SEE OWNER'S MANUAL FOR ADDITIONAL INFORMATION
FRONT	ST215/75R14C	50 PSI	
REAR	ST215/75R14C	50 PSI	
SPARE	ST215/75R14C	50 PSI	

Figure S25: Sample Tire Label

- 4: Replace the valve cap.

- 5: Repeat this procedure for each tire, including the spare.

Tire Care:

Periodically inspect the tire treads for uneven or excessive wear and remove objects such as stones, nails, or glass that may be wedged in the tire grooves. Check for holes or cuts that may permit air leakage from the tire and make necessary repairs. Also inspect the tire sidewalls for cracking, cuts, bulges, and other signs of damage or excessive wear. If internal damage to the tire is suspected, have the tire removed and inspected in case it needs to be repaired or replaced. For your safety, tires that are damaged or show signs of excessive wear should not be used because they are more likely to blow out or fail. Improper or inadequate trailer maintenance can cause tires to wear abnormally. Inspect your tires, including the spare frequently, and replace them if one or more show signs of damage or excessive wear.

NOTICE:

AGE

Tires degrade over time, even when they are not being used. It is recommended the tires generally be replaced after 6 years of normal service. Heat caused by hot climates or frequent high loading conditions can accelerate the aging process. You should replace the spare tire when you replace the other tires due to the aging of the spare tire.

D. Load Carrying Capacity

The certification label shows the maximum load-carrying capacity and is located on the port forward side of the trailer. See Figure S24.

GVWR is the Gross Vehicle Weight Rating. It is the total combined weight of the trailer and its maximum load-carrying capacity. DO NOT exceed the GVWR rating for the trailer.

Total Load is the maximum load-carrying capacity of the trailer minus the weight of the trailer.

Locate the statement “Total load should never exceed XXX kg or XXX lbs.” on your trailers tire label located on the port forward side of your trailer.

This figure equals the available amount of the boat with all equipment, gear, fuel, water, and luggage load capacity.

Determine the combined weight of the boat with all equipment, gear, fuel, water, and luggage being loaded on the trailer. That weight may not safely exceed the tire labels total load.

Improper weight distribution can place excessive strain on the towing vehicle and trailer. It can also cause the trailer to “fishtail” (sway side to side). Be sure gear and luggage are distributed evenly in the boat.

E. Glossary of Tire Terminology

Tire label: A label showing the tire sizes, recommended inflation pressure, and the maximum weight the trailer can carry.

Tire Identification Number (TIN): A number on the sidewall of each tire providing information about the tire brand, manufacturing plant, tire size, and date of manufacture. It is also referred as the DOT code.

Inflation pressure: A measure of the amount of air in a tire.

kPa: Kilopascal, a metric unit of air pressure.

PSI: Pounds per square inch, a standard unit of air pressure.

Cold tire pressure: The tire pressure when the trailer has been stationary and out of direct sunlight for an hour or more and prior to the trailer being pulled 1 mile (1.6 km)

Recommended inflation pressure: The cold inflation pressure found on the certification label or tire label located on the port forward side of the trailer.

Bead area of the tire: Area of the tire next to the rim.

Sidewall of the tire: Area between the bead area and the tread.

Tread area of the tire: Area of the perimeter of the tire that contacts the road when mounted on the trailer.

Rim: The metal support (wheel) for a tire upon which the tire beads are seated.



T - 1 LAUNCH AND CRUISE CHECKLIST

- Get a current weather report. If the weather will not be favorable, postpone your trip.
- If your boat has been out of the water, check to see that all bilge water has drained out.
- Install hull drain plugs.
- Inspect the hull and propeller for damage. Excessive dirt or marine growth will effect your boat's performance and fuel efficiency.
- Check the electrical system and navigation lights.
- If your boat has been in the water, run the bilge pump until the flow of water stops.
- Check that all required safety equipment is on board and in good working condition. Examples include personal flotation devices (PFDs), horn, fire extinguisher, visual distress signals, etc. Take along extra drinking water.
- Check that other important equipment is on board. Examples include mooring lines, anchor and line, tool kit, first aid kit, etc.
- Open engine compartment. Inspect for fuel odors and visible leaks in the fuel, oil, coolant, exhaust and power steering systems.
- Visually inspect engine for cracked hose, defective belts, or other signs of engine problems. Check engine oil and battery water levels. Check power steering fluid level. Check battery electrolyte range.
- Check fuel level. Fuel tank(s) should be filled to slightly less than capacity. Allow for fuel expansion.
- Check that all engine drains are closed (stern drives).
- Make sure navigation charts and equipment are on board.
- Check operation of steering system, navigation lights, and operation of horn.
- Make sure passengers and crew know what to do in case of an emergency and how to operate safety equipment.
- Make sure all required documents are on board.
- File a float/trip plan with a responsible party ashore.
- Keep an eye on the weather. Be aware of possible changing conditions by monitoring local weather broadcasts prior to departure. The captain or first mate should personally monitor strong winds and electrical storms.
- Always keep accurate up-to-date charts of your boating area on board.

T - 2 FUELING

 **WARNING**

Do not smoke; extinguish all open flames, STOP all engines and other devices that could cause sparks, including the bilge blower. Do not use electrical switches or accessories. Shut OFF all stoves that may produce a spark or flame. Close all openings into the cabin area of the boat.

A. Recommendations

 **WARNING**

When fueling or having your boat fueled by an attendant, be sure the waste pump-out or fresh water fitting is not mistaken for the gas fill.

Although alcohol boosts the octane level of gasoline, it also attacks the rubber fuel distribution lines and even metal fuel system components. Alcohol will permeate most fuel hoses and other components such as fuel pump, gaskets and seals, and can also contribute to fuel system contamination.

The hoses we use in our boats are alcohol-resistant as are the materials used by the engine manufacturers. If only fuel containing alcohol is available, or the presence of alcohol is unknown, you must perform more frequent inspections for leaks and abnormalities. Any sign of leakage or deterioration requires your immediate attention. Refer to the engine manufacturer's recommendations on fuel type and octane ratings.

B. Preliminary Guidelines

1. Safely secure your boat to the dock.
2. Close all hatches, windows, doors and compartments to prevent accumulation of fuel vapors.
3. Ensure that a fire extinguisher is readily available.
4. Do not store fuel in areas that are not adequately ventilated.
5. Use only fuel lubricants recommended by the engine manufacturer.

C. Pumping Fuel

 **WARNING**

Follow engine manufacturer's recommendations for types of fuel and oil. Use of improper products can damage the engine and void the warranty.

1. Be sure to fuel in a well-lit area; gasoline spills are unnoticeable under poor lighting or in the dark.
2. Remove the gas fill cover.
3. Insert the fuel supply nozzle, keeping it in contact with the fuel fill plate to guard against static produced sparks.
4. Stand away from the fuel tank vent and gas fill during fueling. Splashback may occur and can be an eye irritant and/or a fire hazard.
5. Avoid spillage. Wipe up any excess fuel immediately.
6. After pumping approximately 10 gallons of fuel into the fuel tank, inspect the engine and fuel tank area for any signs of leakage. If no leaks or other problems are detected, resume fueling.
7. Allow space at the top of the tank for thermal expansion.
8. If fuel cannot be pumped in at a reasonable rate, check for fuel vent blockage or a kink in the line.

D. After Fueling

1. Replace the gas fill cover and wipe up any fuel spilled. Discard rags used in a safe place ashore.
2. Open the engine compartment and all hatches, windows, doors and other compartments that were closed during fueling. Inspect these areas for the odor of fuel vapors and visible fuel leakage.

 **WARNING**

Investigate and correct any sign of fuel leakage or indication of vapors before starting engine. Do not run blower or operate any electrical switch until problem is corrected. Fire or explosion may result.

T - 3 LOADING PASSENGERS AND GEAR

NOTE: All boats under 20 feet in length must have a capacity rating plate showing the recommended person capacity as well as the maximum capacity of the boat including persons and gear.

When loading your boat, remember to distribute the load evenly. Keep the load low and do not overload. The capacity plate affixed to your boat states the maximum load capacity. The plate shows in pounds, the amount of persons and gear that the boat will safely handle under normal conditions. US Coast Guard regulations establishes these load capacity ratings. Position passengers and gear so that the load is balanced. See Figure T1.

NOTICE

The NMMA Yacht Certification rating (indicated by a yacht certification plate - applicable models only) places the responsibility on the captain to make the determination as to the appropriate load, load placement and number of passengers permitted aboard the vessel.

When loading, always step into the boat, never board by jumping. Have someone on the dock pass your gear aboard. Secure all gear firmly so it doesn't move or interfere with operation of the boat. Passengers should board the boat one-at-a-time and be seated. Passengers should remain seated during loading of the boat to maintain an even trim.

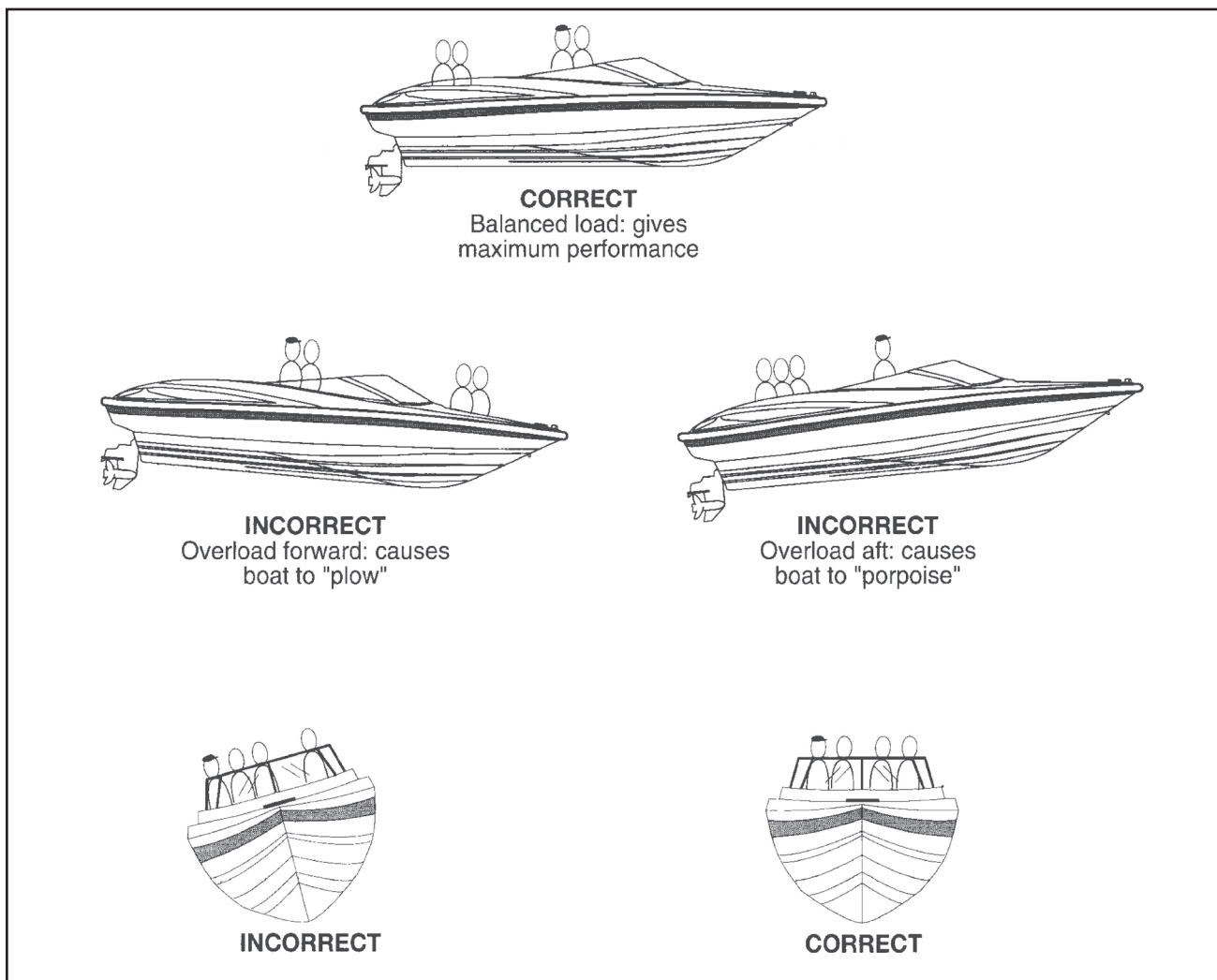

Figure T1: Loading Passengers and Gear

 **WARNING**

Passengers seated in the bow area should not obstruct the driver's vision.

IMPORTANT: Passengers are prohibited from riding on the bow with feet hanging over the side or ride while sitting on the stern, gunwales or seatbacks. The Coast Guard considers these acts to be negligent or grossly negligent operation. They are prohibited by law because falls from moving boats are a major cause of fatal recreational boating accidents.

IMPORTANT: The presence of the capacity plate does not relieve the boat operator from the responsibility of using common sense or sound judgment. Turbulent waters and adverse weather conditions will reduce the maximum load capacity rating of the boat.

T - 4 STARTING PROCEDURES

The operation and maintenance manual supplied with your engine provides pre-start, starting and cold-starting instructions. The following information is merely a guide and not intended to explain in detail all starting procedures and instructions. Refer to your engine owner's manual.

A. Preliminary Checks

1. Secure boat to the dock before attempting to start engine. The boat should be kept secure until the engine is running and warmed up.
2. Operate the bilge pump until the flow of water stops.
3. Check all electrical systems and navigation lights.
4. Make sure the throttle is in the neutral position and stern drive or outboard is lowered into water.
5. Make sure passengers seated in the bow area do not obstruct the driver's vision.

B. Starting

 **DANGER**

To prevent excessive exposure and reduce the possibility of carbon monoxide accumulation in the cockpit areas of the boat, the operator should provide adequate ventilation in each of these areas. Utilize hatches, doors, windows and side vents to increase air movement. See Section B-2 for information about the dangers of Carbon Monoxide.

Notice: Additional starting information is located in Section A.

1. If your boat is equipped with a battery switch, turn the battery switch to I (ON), or COMBINED BATTERY position (positions may vary depending on which model you have).
2. Attach the ignition interrupt lanyards securely to your body. In the event that you move away from the helm area and beyond the length of the lanyard, the engine will be turned off.
3. If your boat has fuel injection, turn the key to start the engine. Engine will not turn over if throttle is not in the neutral position.

If your boat does not have fuel injection, depress the engine warm-up button to advance the throttle several times and leave it in the SLOW/START position. This will actuate the carburetor accelerator pump and feed fuel to the engine. Turn ignition key to START position.

4. When engine is cold, run engine approximately one (1) to two (2) minutes at fast idle speed (1200 to 1500 rpm). This step is not necessary with fuel injected engines.
5. Once engine has warmed up, check water temperature gauge to ensure engine temperature stays within optimum range. If temperature reading is abnormally high, stop engine immediately and inspect for cause of high reading.
6. With engine running, voltmeter should show a reading between 12 and 15 volts.

7. Check steering operation. Turn steering wheel full to port and starboard while observing outdrive movement.
8. Inspect for fuel odors and visible leaks in the fuel, oil, coolant, exhaust and power steering systems.
9. Make sure boat is securely moored to the dock and engine is idling. Then move the throttle forward and then aft and back to neutral to check for proper operation of the shifting motion. Be careful. Leave the engine in gear for only a split-second.

T - 5 MANEUVERING



Boat steering is not self-centering. Steering is effected by engine and propeller torque, trim tab setting, wave and current action and the speed of the hull through the water. Constant attention to steering is required for safe operation.

When all your pre-departure checks have been completed and the engine has warmed up, you will be ready to leave the dock. Take into account the amount of wind, tide current, and other forces that may affect your maneuvering as you leave the dock. Idle speeds work best when maneuvering to and from the dock. Do not forget to release the mooring lines.

A. Leaving the Dock

You are ready to leave the dock after the engine has warmed up. Check all gauges for appropriate readings before casting off. If oil pressure is abnormally low or engine temperature is abnormally high, stop the engine immediately. Check voltmeter to be sure the charging system is working properly. Check for fuel, oil, and exhaust leaks. Correct the cause of any abnormal condition before getting underway.



Make sure passengers sitting in the bow area do not obstruct the operator's vision when casting off or while underway.

After making sure your boat is ready, check wind, tide, current and other forces that will affect the way you maneuver your boat away from the dock. Throw mooring lines off to your boat. Shift your boat's engine into forward or reverse depending on whether you want to move the bow or the stern away from the dock first. Run your engine at a slow speed as you move away from the dock. If you move the bow out first, watch that the stern of the boat does not swing into the dock or a piling.

Once away from the dock, devote some time to learning how to maneuver. Practice docking using an imaginary dock. Practice stopping and reversing.

B. Stopping

Boats have no brakes. Stopping is accomplished by backing down on the throttle. Practice stopping maneuvers and learn early how your boat reacts. From forward motion, pull the throttle back towards NEUTRAL. Depending on your speed, the distance the boat travels until it comes to a complete stop will vary. The ability to measure the distance will only be acquired through experience.

Once the boat has slowed and motor is idling, place the shift in REVERSE. Gradually increasing reverse power with the throttle will allow you to stop the boat in a very short distance.

NOTE: A boat will not respond to steering in reverse nearly as well as it does when going forward, so do not expect to accomplish tight turning maneuvers when backing up.

Remember that all boats steer by the stern (the feeling is much like steering your automobile in reverse). This means that the stern of your boat will swing in the direction opposite to your turn. For example, when you turn the helm wheel to the left, the stern of your boat will swing in the direction opposite to your turn. This is especially important to keep in mind when docking, operating in close quarters with other boats, or when approaching a swimmer or downed skier in the water.

Always look behind you and to both sides of the boat before slowing down. Tell your passengers your intentions to allow them time to make adjustments to their balance or positions.

Slowly pull back on throttles, glance back and see if a large following wave is approaching the transom. If so give the engines a little throttle as the wave arrives to keep wave from rolling over the transom.

Once you have spent enough time practicing maneuvers and have a feel for how the boat handles, you will be ready to run in open waters.

T - 6 ACCELERATION

 **WARNING**

Before accelerating to bring your boat on plane, be sure that the area in front of your boat is clear. The bow will rise out of the water momentarily before you plane and may temporarily obstruct your vision.

If you have never had your boat on plane before, choose a calm day for your first on plane experience. Never boat beyond your ability and experience.

Before bringing your boat “on plane”, check the entire area to make sure you have a clear, safe path. As you throttle up to accelerate, your boat will increase its angle of trim, causing the bow to ride high. From a maximum angle, the boat will level out to its planing attitude with continued acceleration. This maximum angle is known as the “hump”. Because visibility, handling, and performance are reduced, it is advisable to get “over the hump” as soon as possible.

A few seconds at full throttle should get the boat over the hump and into its planing attitude.

After getting over the hump, accelerate until reaching a comfortable plane, then throttle down to cruising speed. This also will provide for better fuel efficiency.

T - 7 TRIMMING YOUR BOAT

A. Trim Tabs (Applicable Models Only)

Trim tabs are used to add lift to the boat’s stern, thereby changing the boat’s attitude (see Figure T2). This lift can help the boat get on plane faster and remain on plane at slower speeds than if no tabs were used. Used independently, tabs can also correct listing conditions caused by crosswinds, unbalanced loading and quartering seas. Trimming your boat properly involves two separate procedures, trimming or tilting the lower unit and setting the trim tabs.

When you are sitting dead in the water, your drive should be down and the trim tab switches are in the BOW UP position. Accelerate until you get onto plane. At this point your boat will be plowing through the water with the bow down too far. Trim the lower unit up slightly until the bow comes up. If you trim the lower

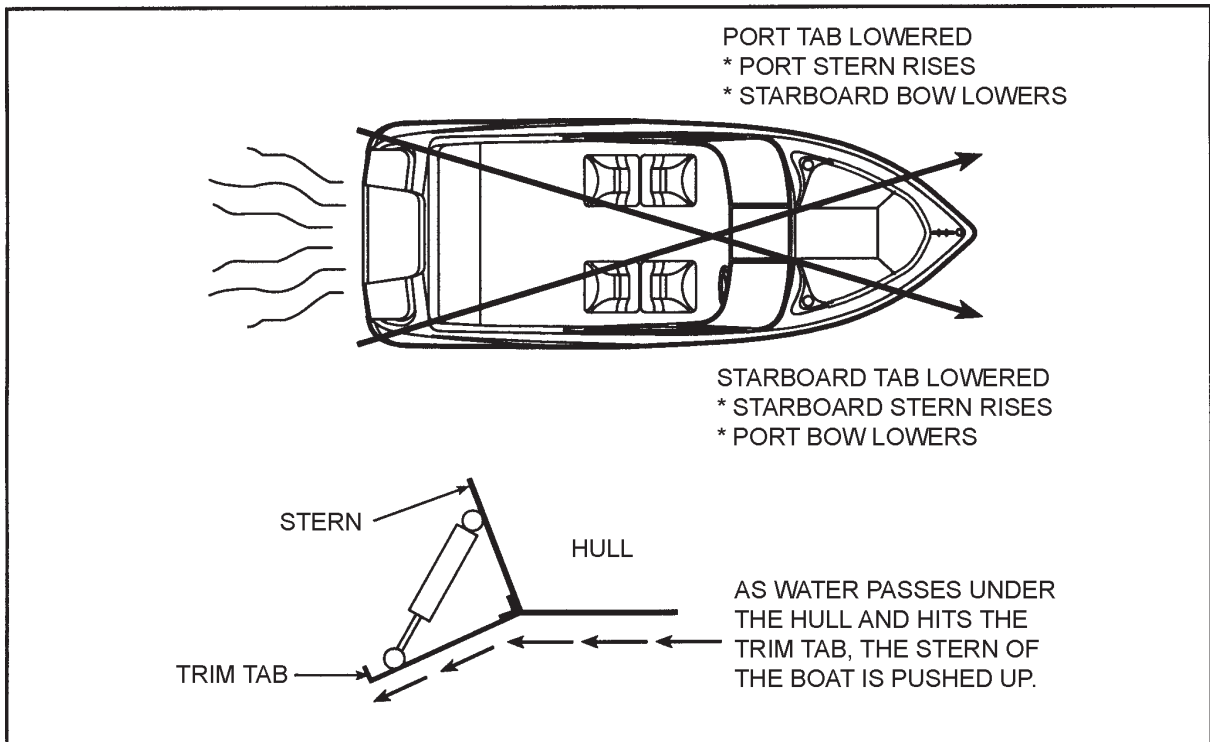

Figure T2: Trimming the Boat with Trim Tabs

unit out too far, your boat will porpoise or the propeller will cavitate, and the bow will slam up and down on the water. Your boat is trimmed correctly when it is just short of porpoising or propeller cavitation, under ideal running conditions.

Trim your boat to compensate for seas, winds, or uneven loads.

Head Seas	Trim drives in more than usual. Use tabs to keep bow down and move at a slower speed.
Following Seas	To prevent taking seawater over the bow, trim drives out and keep tabs up to keep bow up.
Listing Due to Quartering Seas, Beam Wind, or Uneven Load	Use tabs independently to adjust for list. If listing to starboard, press port bow down switch. If listing to port, press starboard bow down switch.

Remember that most boats react very slowly to trim tabs. Often boat owners do not give trim tabs time to work. Press the trim tab switches for only one second at a time and then allow some time for the boat to react. If the boat is still listing after a minute or two, press the trim tab switch again for a one second interval. The labels on the trim tab switches indicate what you want your boat to do, not what you want the tabs to do.

It is a good idea to take your boat out onto open water shortly after you get it and experiment with the trim tabs. After you get your boat onto plane, set the tabs in various positions and note how your boat reacts. This will give you a feel for how the trim tabs work.

It is possible to extend the cylinder life expectancy on your trim tabs. To do this, keep the cylinders retracted while at dockside. Press both trim tab controls down until tabs reach their full up position.

B. Tilt/Trim Control Switches

NOTE: Trim refers to the angle of the lower unit in relation to the bottom of the boat. With respect to trimming, the words in, down, under, and forward, have the same meaning as do up, out, and aft.

1. The standard trim control switch is located on the control lever handle.

2. The switch controls the position of the stern drive. Proper trim is very important in boating.
3. In the case of low or heavy bow attitude, the boat tends to “plow” (Figure T3). The lower unit is trimmed too far under or forward. Trim the unit UP (out) to correct this situation.
4. If the bow is too high, the boat tends to “porpoise” (Figure T5). The drive unit is trimmed up or out too far. Trim DN (in) to correct.
5. A good practice is to get underway (especially when fully loaded or pulling a skier) with the unit trimmed all the way DN (under). After the boat is on plane, adjust the trim out slightly to obtain the proper bow attitude and engine speed.
6. Trim also affects propeller selection and fuel efficiency. All models should be “propped” to be in the upper half of the maximum rpm range with the boat lightly loaded and the drive trimmed up to maximum.

This configuration allows the engine to operate within the recommended rpm range with a heavy load.

The power unit should never be trimmed up to a point where the propeller cavitates (or slips). A rapid increase in engine rpm’s is evidence of cavitation. If this occurs accidentally while running at full throttle, immediately lower the drive trim and reduce the throttle until the slipping stops. If necessary, have your dealer reset the trim limit switch (if provided) to avoid over-trimming in the future.

If the prop slips at lower planing speeds, the drive may be trimmed too high. Immediately lower the drive unit until the prop grabs again to restore efficiency.

7. Trimming out, in addition to raising the bow, also lifts the boat higher, gaining speed because less hull is in the water.
8. The trailering position of some stern drives is controlled by a separate switch on the dash switch panel or throttle/shift control. Do not activate this switch while engine is running. Doing so can severely damage the lower unit and engine.

NOTE: Refer to the control instructions regarding the power trim controls installed on your boat.

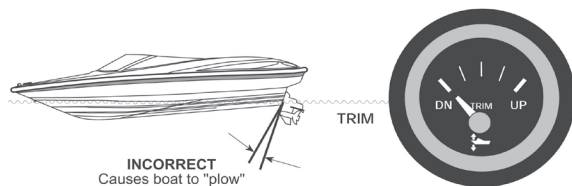

Figure T3

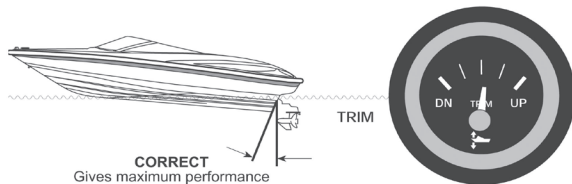

Figure T4

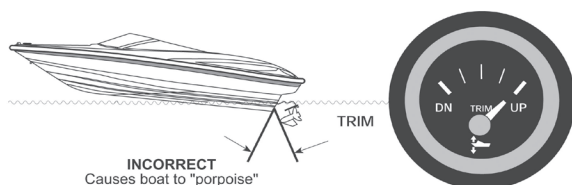

Figure T5

Figures T3-T5: Trimming the Boat with Outdrive

T - 8 NAVIGATION LIGHTS

Although night activities are limited, cruising at night can be very pleasurable. It can also be dangerous if you don't pay close attention to water levels and obstacles. Be especially careful of shallow waters and watch for submerged debris, rocks and other obstacles in the water. Your navigation lights are intended only to prevent collision, not to improve your night vision. You may choose to use a spotlight instead.

NOTE: It is illegal to use your spotlight as a headlight. Use it only temporarily to check the position of your boat and the surrounding area.

Your boat has one white (stern), one red (port) and one green (starboard) light. The stern light may be a removable pole light. To use the light, line up the two-prong plug in the pole with the receptacle in the base. Plug the light in, and lock it into place. When not in use, stow the light inside your boat for safekeeping. This light can be turned on or off at the helm.

Check lights for proper operation before heading out at night. You should also learn to identify the running light combinations for other vessels. We recommend that you participate in a boating safety course to further learn about navigation lights and safe boating practices.

The anchor lights and navigation lights are controlled by a switch at the helm. The anchor light switch allows you to turn on just the stern (white) light when anchored or moored. While underway, use the navigation light switch to turn on the stern (white), port (red) and starboard (green) lights. Lights are off when switches are in the OFF position.

T - 9 HAZARDOUS CONDITIONS

A. Storms

Storms sometimes appear without advance notice. Although weather information from meteorological observation and reporting stations is available, weather bureaus are known to have failures in their predictions or information gathering equipment. There is no substitute for a strong understanding of what action to take when the weather takes a turn for the worse. Many marinas fly weather signals. You should learn to recognize these signals and monitor your local weather forecasts before leaving port.

The present and forecasted weather conditions are of primary consideration, but a threat of possible storms should always be a concern. Observance of the following information will help in your safety afloat if storms do occur:

- Keep a watch on the horizon for approaching storm indicators.
- Turn radio ON. Dial in local weather station and monitor forecast. If your boat has a VHF radio, check the weather channels.
- The best possible situation is to return to a safe port if time allows.
- Close and secure all portals and hatches. Stow all loose gear below deck and tie down any gear required to remain on deck.
- Reduce speed as the seas build. Make sure all passengers are wearing their PFDs.
- If you lose power, keep the boat headed into the waves by rigging a sea anchor off the bow. If there is no sea anchor on board, use a canvas bucket or any object that will offer resistance.
- Radar reflectors (if installed on your boat) should be 18 inches diagonally and placed 12 feet above the waterline.

B. Fog

Fog is a result of either warm surface or cold surface conditions. You can judge the likelihood of fog formation by periodically measuring the air temperature and dew point temperature. If the spread (difference) between these two temperatures is small, you likely will incur a fog situation. Remember the following guidelines:

- Turn on running lights.
- As fog sets in, take bearings and mark your position on the chart while continuing to log your course and speed.
- Make sure all persons aboard are wearing their PFDs.
- If your boat has depth finding equipment, take sounding and match them with soundings on your charts.
- Station a person forward on the boat as a lookout.
- Reduce your speed. From time to time, stop engine and listen for fog signals.
- Sound the proper horn or fog bell at proper intervals to warn other boaters.
- If there is any doubt in continuing boat movement, anchor. Listen for other fog signals while continuing to sound the proper fog horn or bell for a boat at anchor.

C. Running Aground



To prevent boat damage, DO NOT use deck hardware or water ski pylon for towing. Use a commercial towing service.

Operating in shallow water can present a number of hazards. Sand bars in narrow inlets are constantly shifting, making it difficult to mark them with buoys. Sometimes sand bars are indicated by waves as they form into breakers when passing over sand bars. In coastal areas, tides can change water levels by as much as 30 feet. Check with local marinas or Coast Guard stations for tide tables and current charts.

If your boat runs aground, first check persons aboard for injury. Then check for damage to the boat. If the drive unit strikes an underwater hazard, check for boat and drive unit damage. If the engine vibrates excessively after striking an underwater obstruction, it may indicate a damaged propeller. If vibration is notice-

able, return to port slowly to prevent further drive and engine damage from an out-of-balance condition. Watch the temperature gauge to make sure you do not overheat the engine.

If the boat is not taking on any water, it may be possible to rock the boat by shifting the weight of the passengers and gear and by raising the drive unit while reversing the engine.

If you ground your boat on a sand bar, shut down the engine and seek help from another boater or radio for help. See your dealer as soon as possible, as sand ingested in the engine cooling system can cause major engine damage.

D. Warning Markers

It is a good idea to find out about hazardous areas and how they are marked by asking your local authorities.

- Boaters must also recognize the flag designs which indicate that scuba divers are present and keep well clear of the area.
- Watch for swimmers. Swimming areas may not be marked. Steer clear from the area and always remain alert.
- Distress flags indicate a fellow boater is in need of assistance.
- Navigation markers serve as a means of identifying navigable routes and indicate water hazards. Boaters should become familiar with navigation markers and stay within marked boundaries and clear of hazards.

T - 10 REACTING TO EMERGENCIES

Be prepared to deal with emergencies before they happen. Try to formulate a plan for each type of emergency in advance so that decisions can be made quickly and without hesitation. Precious moments lost can mean the difference between losing and saving a life.

A. Flooding

If your boat starts taking on water, activate the bilge pump immediately. Make sure all passengers are wearing their PFDs. Open the engine compartment,

look for the cause of the flooding. Check all hoses, through hull fittings, seacocks and strainers. If flooding occurs as a result of collision or grounding damage, call for assistance and head for shore if possible.

B. Capsizing and Man Overboard

By far, the largest number of boating fatalities involve capsizing and falling overboard accidents. By being prepared ahead of time with an appropriate plan of action, you can greatly lower your chances and your passengers' chances of becoming seriously injured.

C. Capsizing

Wear PFDs or have them readily available at all times. If your boat capsizes, and others were on board, locate them and guide them to the safety of the hull. Even if the boat floats in an upside-down position, stay with it. The boat hull is much easier for rescuers to spot than a human head sticking out of the water. DO NOT attempt to swim ashore, it may be further than it looks.

D. Man Overboard

Think through and follow these procedures if someone in your boat falls overboard.

- Remember, every second counts, you must act fast.
- Move throttles to idle position immediately and yell "MAN OVERBOARD."
- Throw some floating object overboard immediately. Keep your required Type IV PFD accessible at all times for such an emergency.
- Keep the person in the water in sight at all times. Have a passenger do nothing but watch the person. Do not go into the water to help the victim. One person in the water is enough trouble.
- Circle around quickly, approaching into the wind and waves. When the person is alongside, put the engine in neutral and throw them a Type IV PFD with a line attached or extend a paddle or boat hook within his/her reach.

E. Collision

If a serious collision occurs, you should first check the condition of all passengers aboard, then inspect your boat to determine the extent of damage.

1. Make sure all persons aboard are wearing their PFDs.
2. If you need help and your boat has a ship-to-shore radio, first contact the U. S. Coast Guard (VHF Channel 16) or other rescue authorities immediately.
3. Prepare to assist the other vessel unless your passengers and/or boat are in danger.
4. If the bow of the other boat penetrated your boat's hull, prepare to block the opening once the boats are separated.
5. Shore up the hole with a spare PFD or bunk cushion from your boat.
6. While blocking the hole, trim the boat so that the hole is out of the water.

F. Fire

Most fires are caused by electrical problems or careless fueling practices. A fire on board your boat is a serious emergency. You must work quickly to implement safety procedures. If a fire occurs, immediately stop the engine.

1. Make sure all persons aboard are wearing their PFDs.
2. If the fire is small, attempt to put it out with your fire extinguisher. If the fire is in the engine compartment, turn off the bilge blower. Do not open the engine compartment. This feeds oxygen to the fire and may cause it to flare up.
3. If the fire gets out of control, execute a distress signal and call for help if equipped with a ship-to-shore radio.
4. All persons aboard should jump overboard and swim a safe distance away from the flames.

IMPORTANT: All persons aboard should know the location and proper operation of the fire extinguishers.

Guidelines

- Use only approved marine cooking and heating systems.
- Open flames demand constant attention.
- Keep flammable materials in approved containers in a overboard vented locker sealed from the interior of the boat.
- Ensure ventilation systems are unobstructed.
- Remove mooring covers before starting engine.
- Check the bilge for fuel leaks.
- Extinguish smoking materials carefully.
- Use special care with flame or high temperatures around urethane foam.
- Check cleaning products for flammability.
- Ventilate when cleaning or painting.
- Disconnect electrical system from its power source before performing maintenance.
- Replace breaker or fuse with same amperage device.
- Electrical appliances must be within rated amperage of boat circuits. Observe the boat carefully while the electrical system is being energized.
- Allow only a qualified marine electrician to service the boats electrical system.

G. Medical Emergency

Accidents while boating can and may happen. Be prepared to handle these emergencies when they happen. Keeping a first aid kit and dry blankets on board can assist during these situations. It is also a good idea to contact your local Red Cross for information and training on first aid and CPR.

H. Propulsion Failure

Before you call for help regarding an engine or drive unit failure, it is a good idea to eliminate the possibility of simple problems. Turn off the engine and check to see that (1) there is fuel in the tank; (2) the engine cooling intakes on the outdrive are not clogged; (3) props are clean and free of weeds, netting, etc.; (4) no hoses are leaking; (5) there is oil in the engine.

Once you have checked out the possibilities listed above and find they are not the problem, call for help giving your position and a detailed description of your boat.

I. Control Failure

In the unlikely event of a shift/throttle failure, shut down the engine immediately. Carefully check the control connections in the engine compartment to see if they are secure. If not, try to locate the attaching hardware and reassemble. If that is not possible, try to use whatever is available such as paper clips, hair clips, tape, etc., to secure the connections. If a temporary repair is made, return to port at the slowest steerable speed and be prepared to take emergency action should the temporary repair fail also. Have your dealer make repairs before using the boat again.

J. Steering Failure

If a problem with the steering occurs, shut down the engine immediately. Check the connections to the drive unit in the engine compartment. Some boats have a push/pull cable while others will have hydraulic hose connections. With cable connections, check the attaching hardware and tighten it if necessary. If you have hydraulic hose connections, check to see if they are leaking. If so, tighten the connections and check the hydraulic fluid reservoir level. Most stern drives are power assisted and have their own hydraulic reservoir and engine mounted drive pump; check the level of reservoir and drive pump belt. If the steering is not operating properly, do not operate the boat and call for assistance.

K. Additional Underway Information

- Always be aware of local laws on noise limits. Noise means engine noise, radio noise or even yelling by people on your boat. Good seamanship demands that you operate your boat quietly so as not to infringe on the rights of others. Don't use thru-transom exhaust unless you are well off shore.
- You are responsible for any damage or injury caused by your boat's wake. Observe no wake speed zone warnings. Operate your boat with regard for the safety of other boats and people in your boating area.
- Keep your engine well tuned to decrease exhaust hydrocarbon emissions that pollute the air and water.

T - 11 RETURNING TO SHORE

A. Docking

Always approach the dock slowly. Think before acting. If you are wondering whether your boat will fit in a space against a dock, remember that pilings are often (but not always) spaced 10 feet apart.

Remember that it is easier to control a boat in reverse because a boat steers from the stern. When backing into a slip, back so that bow swings into the wind if possible. You will have more control.

If possible, come in against the wind or current, whichever is stronger. Approach the dock at a 30-45° angle. As the boat nears the dock, slowly swing parallel to it. Tie the bow line first; then the stern. If wind or current is moving toward the dock, move parallel to the dock further out. Let the wind or current push you in. Tie the stern first, then the bow.

Use extreme caution if wind or current is from your stern. Back in towards the dock slowly at a slight angle with engine in slow reverse. Gently swing parallel. Tie stern first, then the bow.

If the weather looks bad, use spring-lines from the bow and stern to dock amidships of the boat. Tie up on the downwind side of the dock. If the wind is changeable, place fenders over the side between the boat and the dock.

B. Mooring

After you have positioned your boat next to the dock, you must secure it with mooring lines to keep it in position. Mooring lines must be long enough to secure your boat in any docking situation. For example, the length of the lines for a 16-foot runabout should be at least 15 feet. An eye splice at the end of each line works well with bow or stern cleats.

The mooring lines you will use most often are the bow line, the stern line, and spring lines as shown on Figure T6. Each line has a specific purpose. The bow line and the stern line secure your boat's bow and stern. The two spring lines keep your boat from moving forward or backward when you are moored alongside a dock.

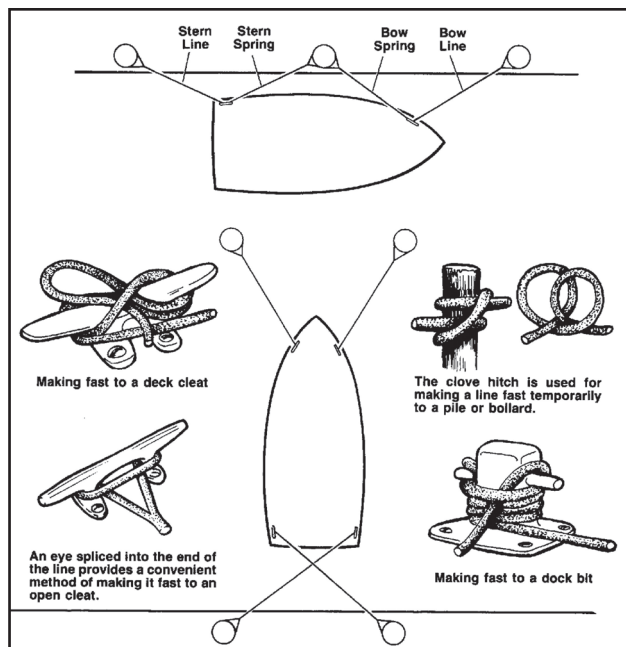

Figure T6: Mooring Lines

If you are mooring your boat for a short time, bow and stern lines may be the only lines you will need. If you are mooring your boat for a longer time or the currents are swift, you should use spring lines. The stern spring line leads from the boat's stern cleat forward to the piling or cleat on the dock. The bow spring line leads from the bow cleat aft to the dock.

If you are mooring your boat in a slip, bow and spring lines, port and starboard, will keep your boat in position.

NOTE: If tides are a consideration, be sure to leave slack in the lines to make up for the rise and fall of the water while your boat is docked.

ABAFT - Toward the rear of a boat.

ABEAM - At right angles to the keel of the boat.

ABOARD - On the boat.

ABREAST - Side by side.

ADRIFT - Loose, not on moorings or towline.

AFT - Moving toward the stern, you are going aft.

AGROUND - Stuck fast to the bottom.

AHEAD - In a forward direction.

ALEE - Away from the direction of the wind; opposite of windward.

ALOFT - Above the deck.

AMIDSHIPS - 1. An object or area midway between the bow and stern. 2. An object or area midway between the port side and the starboard side of a vessel.

AMPERE - The standard unit used to measure the draw of an electrical current.

ANCHOR RODE OR ROPE - The line (chain) connecting a vessel to its anchor.

ANCHOR BALL - A black, circular, day signal hoisted to show that a vessel is anchored. Replaced at dusk by the anchor light.

ASTERN - Anywhere behind the boat, a reverse direction, opposite of ahead.

ATHWARTSHIPS - A line, or anything else, running perpendicular to the fore-and-aft center line of a boat.

BATTEN - A strip of wood or metal used to secure tarpaulin(s) in place over a hatch. To batten down means to secure for rough weather.

BEAM - 1. The widest distance across a boat from the outside skin on one side to the outside skin on the other. 2. A transverse structural member that stiffens and supports a portion of the deck.

BEAM WIND - A wind blowing against the side of the vessel, perpendicular to the long axis of the vessel.

BILGE - The lowest interior area of a hull, used to collect water that has entered.

BILGE PUMP - A pump intended for removal of spray, rainwater, and the normal accumulation of water due to seepage and spillage; not intended for damage control.

BINNACLE - The stand or support for a magnetic compass occasionally used to mean helm.

BITT - A heavy and firmly mounted piece of wood or metal used for securing lines.

BLOCK - A wooden or metal case enclosing one or more pulleys and having a hook, eye, or strap by which it may be attached.

BOLLARD - A single post (wood, metal, or concrete) on a dock, pier, or wharf used to secure a vessel's lines.

BONDING - The electrical connection of exposed metallic, non-current carrying components to a common point on the main engine block.

BOW - The front end of the boat.

BOW LINE - A docking line leading from the bow.

BREAKER - A single breaking, plunging or spilling wave.

BREAKER LINE - The outer limit of the surf. However, all breakers may not be in a line. They can occur outside the breaker line.

BRIDGE - The main vessel control station.

BROACH - The turning of a boat parallel to the waves, subjecting it to possible capsizing.

BULKHEADS - The interior walls of a boat.

BULWARK - The side of a vessel when carried above the level of the deck.

BUOY - An anchored float used for marking a position on the water, a hazard, or a shoal.

CAPSIZE - To turn over.

CAPSTAN - A machine that moves a cylindrical device on a shaft for the purpose of hauling up an anchor.

CAST OFF - To let go.

CATAMARAN - A twin-hulled boat, with the hulls being side-by-side.

CHINE - The intersection of a boat's bottom and side. If this intersection is rounded, it is a "soft" chine. If the intersection is squared off, it is a "hard" chine.

CHOCK - 1. A fitting or hole in a railing or deck through which a mooring or anchor line is routed.
2. A wedge used to secure an item in place.

CIRCUIT BREAKER - A device used to interrupt an electrical circuit when current flow exceeds a predetermined level.

CLEAT - A double-ended deck fitting to which lines are secured; usually anvil-shaped.

COAMINGS - Raised lips around cockpits or hatches used to keep water from entering

COCKPIT - An exposed deck area (usually aft) that is substantially lower than the adjacent deck.

COMBER - A wave on the point of breaking. A comber has a thin line of white water on its crest, known as "feathering."

COMPANIONWAY - The steps or ladder leading downward from a deck.

COMPARTMENTS - Rooms divided by bulkheads.

COUNTER - The overhang at the stern of a boat.

CRADLE - A framework, generally made of wood, used to support a boat when it is out of the water.

CREST - The top of a wave, breaker or swell.

CUDDY - A small sheltered cabin in a boat.

CURRENT - 1. The movement of water,
2. The flow of electrical charge.

DEAD AHEAD - Directly in front of the boat.

DEAD RECKONING - A plot of courses steered and distances traveled through the water.

DECK - A permanent covering over a compartment, hull or any part thereof.

DESIGNATOR - Model identifier or model name.

1. to mark or point out; indicate; show; specify.
2. to denote; indicate; signify.
3. to name; entitle; style.

DINGHY - A small, open boat used for ship to shore transportation.

DISPLACEMENT - The weight of water displaced by the hull of a vessel.

DISPLACEMENT HULL - A hull that "displaces" a volume of water equal to the weight of the boat. A hull designed to run in the water rather than on top of the water. When a displacement hull moves through the water, it pushes that water out of the way. Water will then flow around the hull and fill the "hole" the boat leaves astern.

DOCUMENTED VESSEL - Documented yachts have been specially registered with the U.S. Coast Guard. All documented yachts must have their name and home (hailing) port marked on some conspicuous place on the hull. Numbering is not required. Advantages include legal authority to fly the yacht ensign, privilege of recording bills of sale, and other instruments of title with federal officials, and preferred status for mortgages. Documentation does not exempt the unit from any State or Federal taxes. All safety and equipment regulations still apply.

DOLPHIN - A group of piles driven close together and bound with wire cables into a single structure.

DRAFT - 1. The depth of a boat from the actual water line to the bottom of the lowest part of the boat (e.g., the propeller tip or rudder). 2. The depth of water necessary to float a boat.

DROGUE - Any device streamed astern to check a vessel's speed, or to keep its stern up to the waves in a following sea.

DYE MARKER - A brightly colored chemical that spreads when released into water; normally used to attract attention.

EBB TIDE - A receding tide.

EVEN KEEL - To be floating evenly without listing to either side.

EXHAUST SYSTEM - The means by which the hot engine (or generator) exhaust gases are moved from the engine to an outboard port and then released into atmosphere.

EYE SPLICE - A permanent loop spliced in the end of a line.

FAST - Said of an object that is secured to another.

FATHOM - Six feet.

FENDER - A device (usually constructed of rubber or plastic) positioned so as to absorb the impact between vessels or dock.

FETCH - The unobstructed distance that the wind can blow over the water to create waves.

FLARE - 1. Outboard curve of the hull as it comes up the side from the waterline; the reverse of tumble home. 2. A pyrotechnic device used for emergency signaling.

FLAT - A small deck that is built below decks, specifically to support a piece of equipment.

FLEMISH - To coil down a line or rope on deck in a flat, circular, concentric arrangement.

FLOTSAM - Floating wreckage, trash or debris.

FLUKE - The palm of an anchor.

FOAM CREST - The top of the foaming water that speeds toward the beach after a wave has broken, commonly referred to as "white water."

FOLLOWING SEA - A sea (waves) moving in the same direction as a vessel.

FORE-AND-AFT - A line, or anything else, that runs parallel to the longitudinal center line of a boat.

FOREFOOT - The portion of a vessel's keel that curves upward to meet the stem.

FOREPEAK - A compartment in the bow of a boat.

FORWARD - Toward the bow.

FREEBOARD - The minimum vertical distance from the surface of the water to the gunwale.

FREQUENCY - The number of crests passing a fixed point at a given time.

FRONTS - Where opposing warm and cold air masses meet, generally producing a band of wet, stormy weather wherever they meet.

GALLEY - The kitchen area of a boat.

GALVANIC CORROSION - A potential electrical difference exists between dissimilar metals immersed in a conductive solution (e.g., salt water). If these metals touch or are otherwise electrically connected, this potential difference produces an electron flow between them. The attack on the less corrosion resistant metal is usually increased and the attack on the more resistant metal is decreased, as compared to when these metals are not touching.

GANGWAY - The area of a ship's side where people board and disembark.

GASKET - A strip of sealing material, usually rubber, set along the edge of a water or gas tight door, port, cover or hatch.

GELCOAT - The thin outer layer of pigmented plastic covering a fiberglass vessel.

GLAND - The movable part of a stuffing box, which when tightened, compresses the packing.

GROUND - Electrical term meaning the electrical potential of the earth's surface, which is zero.

GROUND SPEED - A vessel's speed made good over the earth's surface along a course or track.

GROUND TACKLE - The anchor, anchor rodes, and other fittings that are used to secure a vessel at anchor or dockside.

GUNWALE - 1. The line where the upper deck and the hull meet. 2. The upper edge of a boat's side.

HALYARD - A line used to hoist a flag or pennant.

HATCHES - Cover on hatchways.

HATCHWAYS - Access ways through decks.

HARDTOP - A permanent cover over the cabin or cockpit.

HAWSER - A heavy rope or cable used for mooring or towing.

HEAD - A toilet or lavatory area.

HEADING - The direction that a vessel is going with reference to true, magnetic, or compass north.

HEADWAY - The forward motion of a vessel through the water.

HEAVE TO - To bring a vessel up in a position where it will maintain little or no headway, usually with the bow into the wind.

HEAVY WEATHER - Stormy weather with high seas and strong winds.

HEEL - To tip to one side.

HELM - The wheel or tiller that manually controls the boat's steering system.

HELMSMAN - The individual steering the vessel.

HIGHS - A center of pressure surrounded by lower pressure on all sides. Caused by a mass of cooler, sinking, drier air. This raises the area ground level air pressure and provides clear skies.

HULL - The main body of a boat.

INBOARD - 1. From either the port or starboard side of a boat toward the fore-and-aft centerline of a boat. 2. The dock side of a moored boat.

INLAND RULES - Nautical "Rules-of-the-Road" that apply in U.S. lakes, rivers, and coastal waters.

INTERNATIONAL RULES - Nautical "Rules-of-the-Road" that are in effect by international agreement to the high seas.

ISOBARS - Lines of equal air pressure that connect all the local points on a weather map. These lines are usually closed and define high or low pressure air masses.

ISOTHERMS - Isotherms are lines that are similar to isobars except that isotherms connect all the points that are of equal temperature.

JETSAM - Refuse that sinks when discharged overboard.

KEDGE(S) - One or more anchors set out from a grounded vessel, usually astern, to 1) keep it from being driven further aground and 2) to aid in refloating.

KEEL - 1. The centerline of a boat hull bottom running fore and aft, 2. The backbone of a vessel.

KNOT - 1. A maritime unit of speed equal to one nautical mile per hour (6076 feet). 2. A term for hitches and bends.

LANYARD - A short line made fast to an object to secure it.

LATITUDE - The measure of angular distance in degrees, minutes, and seconds, north or south of the equator.

LAZARETTE - Storage compartment in the deck at the stern.

LEADLINE - A weighted line used to take depth measurements.

LEE - The direction opposite that of the wind.

LEEWARD - Away from the wind.

LIST - A vessel that inclines to port or starboard.

LORAN - Long Range Navigation. An electronic system whereby a navigator can determine position regardless of weather.

LONGITUDINAL - Running lengthwise.

LOWS - A region of low atmospheric pressure. Hurricanes are extremely concentrated low pressure systems.

LUBBER LINE - A mark or line on the compass parallel to the keel indicating forward.

MAST - A spar that is set upright to support lighting, rigging, or sails.

MODEL DESIGNATOR - Model identifier or model name.

MOORING - An arrangement for securing a boat to a mooring buoy or pier.

NAVIGATION LIGHTS - A set of red and green or white lights which must be shown by all vessels between dusk and dawn.

OVERHEAD - A ceiling or roof of a vessel.

OVERBOARD - Over the side of the boat.

OUTBOARD - 1. From the fore-and-aft centerline of a boat toward both the port and starboard sides. 2. The seaward side of a moored boat. 3. An engine that is mounted externally onto the transom of a boat.

PAINTER - A line to the bow of a small boat used for making fast.

PASSAGEWAY - A corridor or hallway aboard ship.

PENNANT - The line by which a boat is made fast to a mooring buoy; also pendant.

PERSONAL FLOTATION DEVICE (PFD) - A life preserver.

PIER - A loading platform that extends at an angle from the shore.

PILASTER - A rectangular structural support column that is an extension of the port and starboard aft cabin sides and which supports the hardtop and flybridge.

PILING - Support, or protection for wharves, piers, etc.

PITCH - 1. The vertical (up and down) motion of a bow in a seaway, about the athwartships axis. 2. The axial advance of a propeller during one complete revolution.

PITCHPOLING - A boat being thrown end-over-end.

PLACARD - A board or stiff card bearing a notice, advertisement, message, etc.

PLANING HULL - At slow speeds, a planing hull will displace water in the same manner as a displacement hull. As speed is increased, the hull provides a lifting effect up onto the surface of the water.

POINT - One of 32 points of the compass that is equal to 11-1/4 degrees.

PORT - 1. Looking forward, the left side of a boat, 2. A harbor, 3. An opening for light or ventilation or passage of material in the side of a boat.

PORT BEAM - The left-center of a boat.

PORT BOW - Facing the bow, the front left side.

PORT QUARTER - Looking forward, a vessel's left rear section.

QUARTER - The sides of a boat aft of amidships.

QUARTERING SEA - Sea coming on a boat's quarter.

RED-RIGHT-RETURNING - A term for helmsmen that buoys and day markers are on the right when returning from seaward.

REEF - A shallow underwater barrier.

REEVE - To pass a line through a block or other opening.

RIDGES - High pressure fingers extending out from a high.

RODE - The anchor line or chain.

RUNNING LIGHTS - Lights required to be shown on boats underway between sundown and sunup.

RUDDER - A vertical plate for steering a boat.

SALON - The main social cabin on a vessel, usually the largest area, occasionally referred to as the deckhouse.

SCREW - A propeller.

SCUPPER - A drain from the edge of a deck that discharges overboard.

SEACOCK - A positive action shut-off valve connected directly to the hull seawater intake and discharge piping.

SERIES - A group of waves which seem to travel together and at about the same speed.

SHACKLE - A “U” shaped connector with a pin or bolt across the open end.

SHAFT - The long, round member that connects the engine or transmission to the propeller.

SHAFT LOG - A fitting at the hull bottom where the shaft connecting an engine to its propeller penetrates the hull. A shaft log permits the shaft to rotate while simultaneously preventing water from entering the hull.

SHEER - The top of the hull’s curvature at the deck line from the bow to the stern.

SHEER STRAKE - The upper edge of the hull, immediately below the deck.

SHEET BEND - A knot used to join tow ropes.

SHOAL - An area of shallow water.

SILENCER - A baffled chamber installed in an exhaust system to reduce the noise.

SOLE - Term for deck, cabin or cockpit floor.

SPAR - A general term for booms, masts, yards etc.

SPRING LINE - A pivot line used in docking, undocking, or to prevent the boat from moving forward or astern while made fast to a dock.

STARBOARD - Looking forward, the right side of a boat.

STARBOARD BEAM - The right-center of a boat.

STARBOARD BOW - When facing the bow, the front right side.

STARBOARD QUARTER - When looking forward, the right rear section of the boat.

STEERAGEWAY - The lowest speed at which a vessel can be controlled by the steering wheel.

STEM - The leading edge of a boat’s hull.

STERN - The back of a boat.

STRINGER - A fore and aft continuous member used to provide a vessel longitudinal strength.

STRUT - A propeller shaft support that is below the hull.

SUMP - A pit or well into which water is drained.

SUPERSTRUCTURE - Deck houses and other structures extending above the deck.

THWART - A seat or brace running laterally across a boat.

THWARTSHIPS - At right angles to the centerline.

TILLER - A bar or handle for turning a boat’s rudder, or motor.

TOPSIDE - To go up to the top deck.

TRANSOM - The stern cross-section of a square sterned boat

TRANSVERSE - Across the vessel; athwartships.

TRIM - Fore and aft balance of a boat.

TROUGH - 1. The valley that exists between waves.
2. A trough is the opposite of a ridge in that it is an elongated low-pressure area extending out from a low. A trough normally indicates unsettled weather.

TUMBLE HOME - The opposite of flare. The shape of the hull as it moves outboard going down from the gunwale to the waterline or chine.

UNDERWAY - Movement. Usually referring to a vessel proceeding forward.

V-BOTTOM - A hull with the bottom section in the shape of a “V.”

V DRIVE - A drive system that has the output of the engine facing forward and coupled to a transmission. The prop shaft is then coupled to the transmission.

WAKE - Moving waves, track or path that a boat leaves behind it when moving across the water.

WATER LINE - The line of the water on the hull when the vessel is afloat.

WATCH - A 4 hour duty period while at sea.

WAVES - Waves are periodic disturbances of the sea's surface, caused by wind, seaquakes, and the gravitational pull of the moon and the sun.



Copy this page and fill out before going boating. Leave the completed copy with a reliable person who can be depended upon to notify the Coast Guard, or other rescue organization, should you not return as scheduled. **DO NOT** file this plan with the Coast Guard.

Name _____ Telephone _____

Description of Boat _____ Type _____ Color _____ Trim _____

Registration Number _____

Length _____ Name _____ Make _____

Four Winns® Hull Identification Number _____

Other Information _____

Persons Aboard: Name	Age	Address	Telephone

Engine Type _____ HP _____

Number of Engines _____ Fuel Capacity _____

Survival Equipment:

PFDs _____ Flares _____ Mirror _____

Smoke Signals _____ Flashlight _____ Food _____

Paddles _____ Water _____ Anchor _____

Raft or Dinghy _____ EPIRB _____ Sea Anchor _____

Navigation Equipment:

Compass _____ Loran _____ GPS _____ Radar _____

Radio: Yes _____ No _____ Type _____ Frequency _____

Phone: Yes _____ No _____ Phone Number _____

Destination _____ Estimated Time of Arrival _____

Expected to Return By _____

AutoType _____ License No. _____ Where _____

If not returned by _____ call the Coast Guard, or _____
Local Marine Authority

Coast Guard Telephone Number: _____

Local Marine Authority Telephone Number: _____

DATE	HOURS RUN	FUEL (GAL.)	RANGE (MILES)	RPM	MPH	GPH

DATE	HOURS RUN	FUEL (GAL.)	RANGE (MILES)	RPM	MPH	GPH

DATE	HOURS RUN	FUEL (GAL.)	RANGE (MILES)	RPM	MPH	GPH











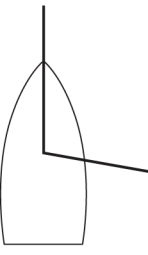





DATE	HOURS	MAINTENANCE PERFORMED

BOAT MODEL	
HULL IDENTIFICATION NUMBER	
ENGINE MODEL	
ENGINE SERIAL NUMBER(S)	
DRIVE MODEL	
DRIVE SERIAL NUMBER(S)	
PROPELLER DIAMETER	
PROPELLER PITCH	
PROPELLER PART NUMBER(S)	
OIL FILTER NUMBER	
BOAT COLOR	
COCKPIT UPHOLSTERY COLOR	
CABIN UPHOLSTERY COLOR	
FUEL CAPACITY	
FUEL: ESTIMATED AVG. GALLON/HR USAGE	
IGNITION KEY NUMBER(S)	
GLOVE BOX KEY NUMBER	
COMPANIONWAY KEY NUMBER	
TRAILER MODEL	
TRAILER COLOR	
TRAILER SERIAL NUMBER	
TRAILER TIRE SIZE & MANUFACTURER	
SELLING DEALER	
ADDRESS	
CITY & STATE	
PHONE NUMBER	
MISCELLANEOUS	

































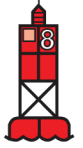

Navigational Aids Chart

**REMEMBER
THESE
RULES**

1. **OVERTAKING - PASSING:** Boat being passed has the right-of-way. **KEEP CLEAR.**
2. **MEETING HEAD ON:** Keep to the right.
3. **CROSSING:** Boat on right has the right-of-way. Slow down and permit boat to pass.

<p style="text-align: center;">← PORT STARBOARD →</p> <div style="display: flex; justify-content: space-around; align-items: center;"> <div style="text-align: center;"> <p>Yield right-of-way to boats in your DANGER ZONE!</p> </div>  <div style="text-align: center;"> <p>DANGER ZONE (Dead ahead to 2 points abaft your starboard beam)</p> </div> </div>	<p style="text-align: center;">STORM WARNINGS</p> <div style="display: flex; justify-content: space-around; align-items: flex-end;"> <div style="text-align: center;">  <p>RED FLAG Small craft (winds to 33 knots)</p> </div> <div style="text-align: center;">  <p>2 RED FLAGS Gale (winds up to 47 knots)</p> </div> <div style="text-align: center;">  <p>SQUARE RED FLAG BLACK BOX (Storm)</p> </div> <div style="text-align: center;">  <p>2 SQUARE RED FLAGS BLACK BOX (Hurricane)</p> </div> </div>								
<p style="text-align: center;">WHISTLE SIGNALS</p> <p>ONE LONG BLAST: Warning signal (Coming out of slip)</p> <p>ONE SHORT BLAST: Pass on my port side</p> <p>TWO SHORT BLASTS: Pass on my starboard side</p> <p>THREE SHORT BLASTS: Engine(s) in reverse</p> <p>FIVE OR MORE BLASTS: Danger signal</p>	<p style="text-align: center;">BRIDGE SIGNALS</p> <table style="width: 100%; border-collapse: collapse;"> <tr> <td style="width: 50%; vertical-align: top;"> <p>SOUND</p> <p>VESSEL: Open — ●</p> <p>BRIDGE: OK — ●</p> <p style="padding-left: 20px;">No ●●●●●</p> <p>VESSEL: Replies: ●●●●●</p> <p>RADIO: VHF CH. 13</p> </td> <td style="width: 50%; vertical-align: top;"> <p>VISUAL</p> <table style="width: 100%; border-collapse: collapse;"> <tr> <td style="text-align: center;">DAY (Flag)</td> <td style="text-align: center;">NIGHT (Lights)</td> </tr> <tr> <td style="text-align: center;">  </td> <td style="text-align: center;">  </td> </tr> <tr> <td style="text-align: center;">Same</td> <td style="text-align: center;">or Same</td> </tr> </table> <p>No </p> </td> </tr> </table>	<p>SOUND</p> <p>VESSEL: Open — ●</p> <p>BRIDGE: OK — ●</p> <p style="padding-left: 20px;">No ●●●●●</p> <p>VESSEL: Replies: ●●●●●</p> <p>RADIO: VHF CH. 13</p>	<p>VISUAL</p> <table style="width: 100%; border-collapse: collapse;"> <tr> <td style="text-align: center;">DAY (Flag)</td> <td style="text-align: center;">NIGHT (Lights)</td> </tr> <tr> <td style="text-align: center;">  </td> <td style="text-align: center;">  </td> </tr> <tr> <td style="text-align: center;">Same</td> <td style="text-align: center;">or Same</td> </tr> </table> <p>No </p>	DAY (Flag)	NIGHT (Lights)			Same	or Same
<p>SOUND</p> <p>VESSEL: Open — ●</p> <p>BRIDGE: OK — ●</p> <p style="padding-left: 20px;">No ●●●●●</p> <p>VESSEL: Replies: ●●●●●</p> <p>RADIO: VHF CH. 13</p>	<p>VISUAL</p> <table style="width: 100%; border-collapse: collapse;"> <tr> <td style="text-align: center;">DAY (Flag)</td> <td style="text-align: center;">NIGHT (Lights)</td> </tr> <tr> <td style="text-align: center;">  </td> <td style="text-align: center;">  </td> </tr> <tr> <td style="text-align: center;">Same</td> <td style="text-align: center;">or Same</td> </tr> </table> <p>No </p>	DAY (Flag)	NIGHT (Lights)			Same	or Same		
DAY (Flag)	NIGHT (Lights)								
									
Same	or Same								

LATERAL AIDS AS SEEN ENTERING FROM SEAWARD

<p style="text-align: center;">PORT SIDE ODD NUMBERED AIDS</p> <div style="margin-bottom: 10px;"> <p>GREEN LIGHT ONLY</p> <p>FLASHING </p> <p>OCCULTING </p> <p>QUICK FLASHING </p> <p>ISOPHASE </p> </div> <div style="margin-bottom: 10px;"> <p style="text-align: center;"></p> <p>LIGHTED BUOY G "9" FI G 4sec</p> </div> <div style="margin-bottom: 10px;"> <p style="text-align: center;"></p> <p>CAN G "7"</p> </div> <div style="margin-bottom: 10px;"> <p style="text-align: center;"></p> <p>DAYMARK G "1"</p> </div>	<p style="text-align: center;">SAFE WATER MID-CHANNELS OR FAIRWAYS NO NUMBERS — MAY BE LETTERED</p> <div style="margin-bottom: 10px;"> <p>□ WHITE LIGHT ONLY □ MORSE CODE</p> <p>Mo (A) □ □ □ □</p> </div> <div style="margin-bottom: 10px;"> <p style="text-align: center;">  SPHERICAL RW SP "G"  MR RW "A"  LIGHTED AND OR SOUND RW "N" Mo (A) </p> </div> <p style="text-align: center;">PREFERRED CHANNEL</p> <p style="text-align: center;">COMPOSITE GROUP FLASHING (2 + 1)</p> <table style="width: 100%; border-collapse: collapse;"> <tr> <td style="width: 50%; vertical-align: top;"> <p style="text-align: center;"></p> <p>GR "C" FI (2 + 1)</p> <p style="text-align: center;"></p> <p>CAN GR "L"</p> <p style="text-align: center;"></p> <p>JG DAYMARK GR "A"</p> </td> <td style="width: 50%; vertical-align: top;"> <p style="text-align: center;"></p> <p>RG "B" FI (2 + 1)</p> <p style="text-align: center;"></p> <p>NUN RG "N"</p> <p style="text-align: center;"></p> <p>JR DAYMARK RG "B"</p> </td> </tr> </table>	<p style="text-align: center;"></p> <p>GR "C" FI (2 + 1)</p> <p style="text-align: center;"></p> <p>CAN GR "L"</p> <p style="text-align: center;"></p> <p>JG DAYMARK GR "A"</p>	<p style="text-align: center;"></p> <p>RG "B" FI (2 + 1)</p> <p style="text-align: center;"></p> <p>NUN RG "N"</p> <p style="text-align: center;"></p> <p>JR DAYMARK RG "B"</p>	<p style="text-align: center;">STARBOARD SIDE EVEN NUMBERED AIDS</p> <div style="margin-bottom: 10px;"> <p>RED LIGHT ONLY</p> <p>FLASHING </p> <p>OCCULTING </p> <p>QUICK FLASHING </p> <p>ISOPHASE </p> </div> <div style="margin-bottom: 10px;"> <p style="text-align: center;"></p> <p>LIGHTED BUOY R "8" FI R 4sec</p> </div> <div style="margin-bottom: 10px;"> <p style="text-align: center;"></p> <p>NUN R "6"</p> </div> <div style="margin-bottom: 10px;"> <p style="text-align: center;"></p> <p>DAYMARK R "2"</p> </div>
<p style="text-align: center;"></p> <p>GR "C" FI (2 + 1)</p> <p style="text-align: center;"></p> <p>CAN GR "L"</p> <p style="text-align: center;"></p> <p>JG DAYMARK GR "A"</p>	<p style="text-align: center;"></p> <p>RG "B" FI (2 + 1)</p> <p style="text-align: center;"></p> <p>NUN RG "N"</p> <p style="text-align: center;"></p> <p>JR DAYMARK RG "B"</p>			



FOUR WINNS®

www.fourwinns.com