



Funship™
Owner's Manual

- Funship*²¹⁴
- Funship*²³⁴
- Funship*²⁵⁴

PREFACE

This manual will acquaint you with the use and maintenance of your new Four Winns® boat. This manual also provides special information critical to the safety of the passengers, and longevity of the equipment. The information on the following page lists the conventions used to increase the visibility of these important messages. Also included in your owner's packet is the "Boating Basics, A Guide to Responsible Boating". This publication covers all the boating basics and should be read along with your Four Winns® Owners Manual before operating your boat. Review this information in detail.

Four Winns® continually strives to improve its products. Unit specifications, including standard and optional equipment are constantly being modified. **Equipment availability is also subject to change. The most current and accurate information available at the time of publication is included in this manual. Some variation in equipment, description, location, and details can result.**

The information in this manual focuses upon the equipment designed and manufactured by Four Winns® on specific models. When appropriate, please utilize the information pertinent to your specific boat model.

Equipment such as engines, and other accessories are manufactured by others. The information provided in this manual is intended to be used in conjunction with the information provided by the manufacturers of this equipment. All information available at the time of manufacture has been included with your owner's packet.

Read this entire manual carefully before operating your new boat. Many instructions may require direct performance of the activity to fully understand the correct method. If you choose to read this manual at home, remember to take it to the boat with you.

Your Four Winns® dealer knows your boat best and is interested in your complete satisfaction. Return to him for service or other assistance. If you find it necessary to contact Four Winns® directly, please refer to the address information listed below. Be sure to include the boat model, serial number, your daytime telephone number, and specifics of the information desired.

This manual has been specifically developed for the Candia Funship 214, 234, and 254 models. Please record the model and serial number information below.

Model

Serial Number

This manual should be considered part of the boat. Should you sell the boat, pass this manual on to the new owner. Take special care of this manual. Certain information in this manual may not be available in a replacement manual.

Thank you for joining the Four Winns® family. We appreciate your purchase and welcome the opportunity to demonstrate our commitment to you.

**Four Winns® Customer Service Department
925 Frisbie Street
Cadillac, Michigan 49601
231-775-1343 (Phone)
231-779-2345 (FAX)
E-Mail Address: boating@fourwinns.com
© FourWinns L.L.C. 2000. All Rights Reserved.**

SAFETY WARNINGS

This manual contains instructions critical to the safety of those aboard or the longevity of the equipment. **Pay close attention to all safety warnings.** The following safety warnings and instructions are used throughout the manual and at selected locations on your boat.



This safety symbol and this signal word indicate an imminently hazardous situation which if not avoided, **WILL** result in death or serious injury.



This safety symbol and this signal word indicate a potentially hazardous situation which, if not avoided **CAN** result in severe injury or death.



This safety symbol and this signal word indicate a potentially hazardous situation which, if not avoided **MAY** result in minor or moderate personal injury or property damage. It may also be used to alert against unsafe practices.

NOTICE

This is used to notify people of installation, operation, or maintenance information which is important but not hazard-related.

YOU are responsible for your own safety, as well as the safety of your passengers and fellow boaters. You should fully understand and become familiar with the operating procedures and safety precautions in this manual and any other information in the Owners Packet before you launch the boat. Always operate your boat with consideration, courtesy, and common sense.

The warnings in this manual do not and can not address every conceivable situation. Always use common sense!

The following page illustrates the locations of various warning labels, capacity label and other stickers on your Four Winns® boat.

LABEL LOCATIONS

The NMMA capacity label and various warning labels are placed at different locations on each model for your safety. Additional warnings for fuel leakage, blower operation, and other important information will be imprinted or located on the dash. Many of these stickers and labels are not required by the U.S. Coast Guard but are important to ensure the safe operation of your Four Winns® boat. In addition, the Hull Identification Number plate is permanently attached below the deck-hull joint on the starboard aft corner.

Below are letters corresponding to the various locations for each item on the drawings. See pages 4 and 5 for the actual wording of each of the various warning labels found on your boat.

- | | |
|----------------------------------|---|
| (A) Helm Boarding Ladder Warning | (B) Boarding Ladder Warning |
| (C) Procedure Checklist | (D) Equipment Checklist |
| (E) Capacity Label | (F) Powered Ventilation for Gas Engines |
| (G) Ski Tow Warning | (H) Transom/Side Door Warning |
| (I) NMMA Certified | (J) Winning Edge Sticker |
| (K) Armorcote Sticker | |

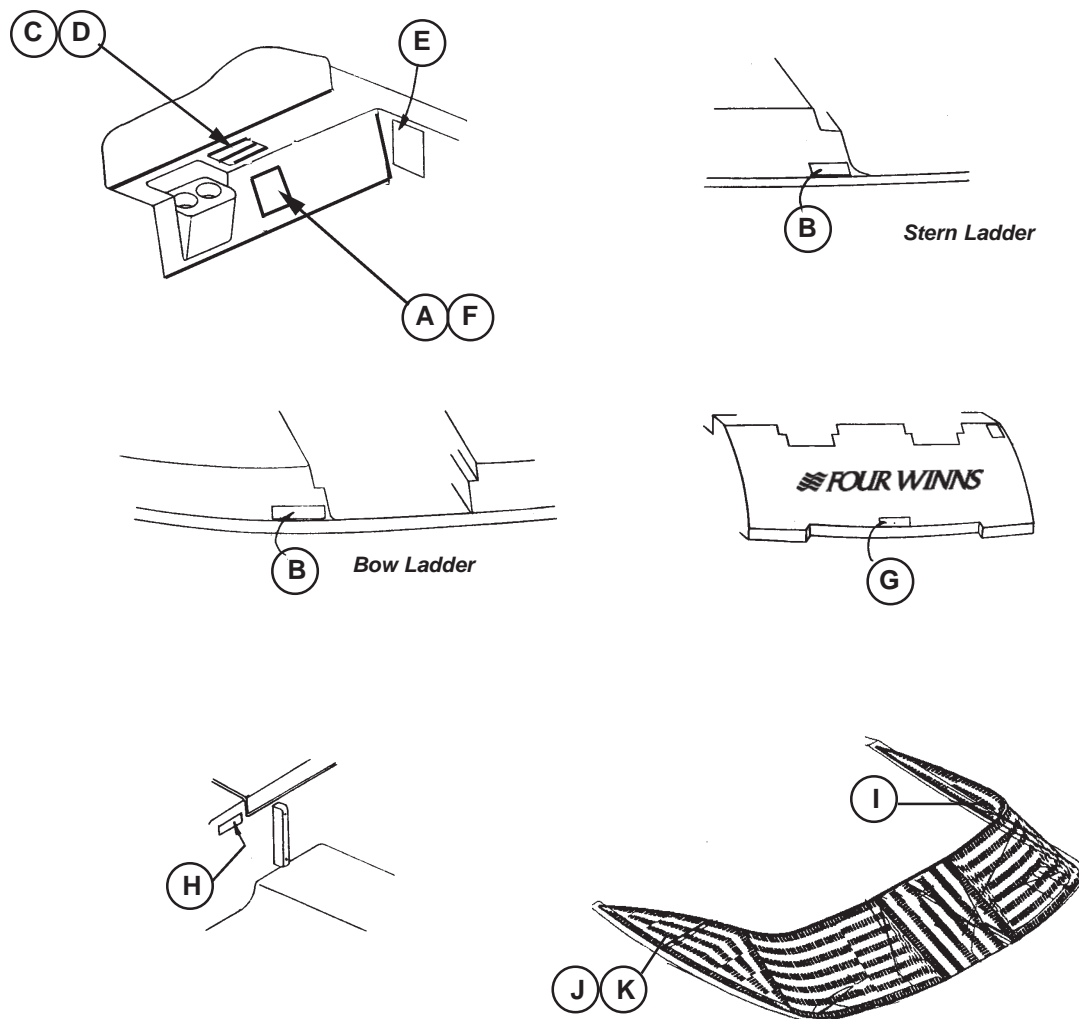
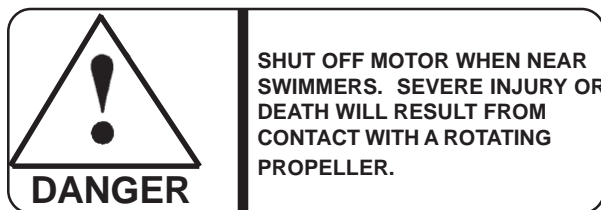
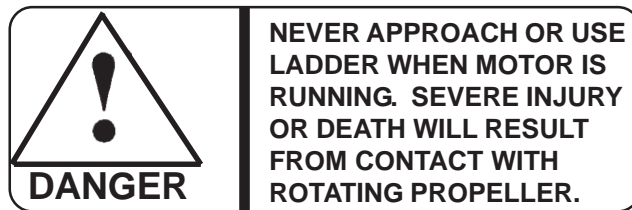

Figure 1: Candia Models

WARNINGS LABELS - LOCATIONS SHOWN ON PAGE 3.



A. HELM BOARDING LADDER WARNING LABEL



B. BOARDING LADDER WARNING LABEL

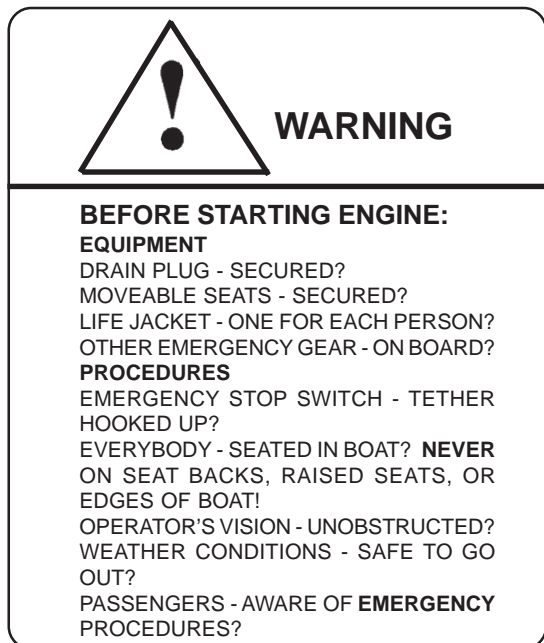

C & D EQUIPMENT AND PROCEDURES CHECKLIST

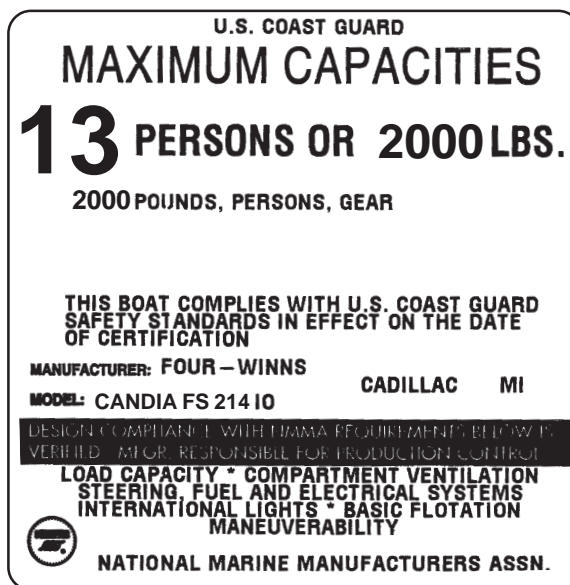

E. CAPACITY LABEL

NOTE: CAPACITY WILL VARY DEPENDING UPON WHICH MODEL YOU HAVE.

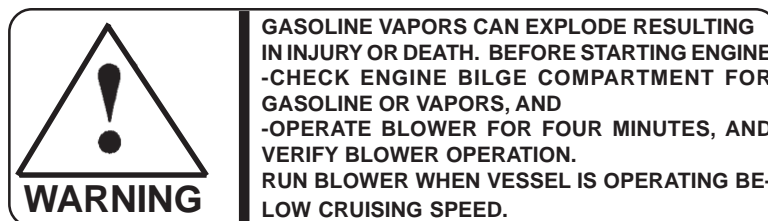

F. POWERED VENTILATION FOR GAS ENGINES LABEL

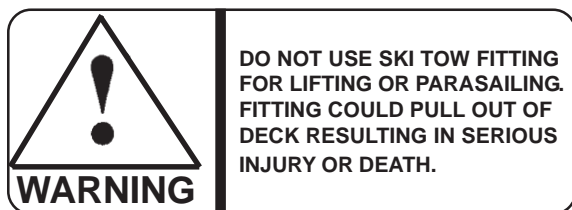

G. SKI TOW WARNING LABEL



H. TRANSOM/SIDE DOOR WARNING LABEL



I. WINNING EDGE STICKER

J. NMMA CERTIFICATION STICKER

K. ARMORCOAT STICKER

ADDITIONAL WARNINGS NOT SHOWN ON PAGE 3.

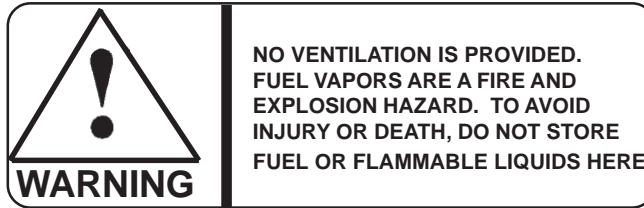

L. NO VENTILATION WARNING LABEL

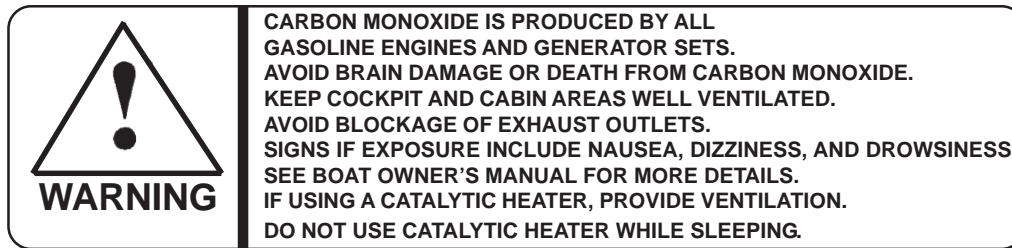

M. CARBON MONOXIDE WARNING LABEL

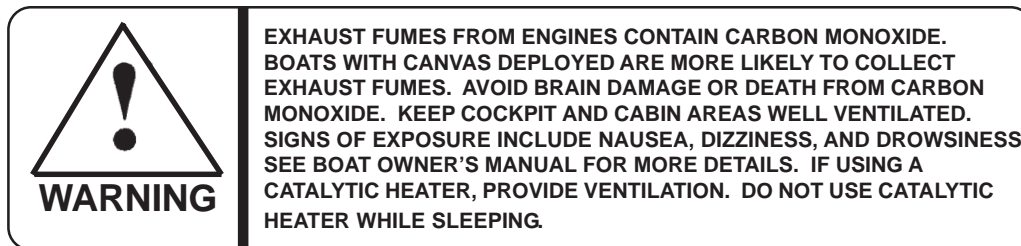

N. CARBON MONOXIDE CANVAS WARNING LABEL

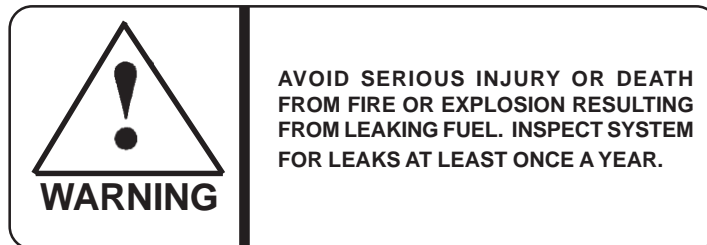

O. LEAKING FUEL WARNING LABEL

SPECIFICATIONS

214 CANDIA FS				
SPECIFICATIONS:	US	METRIC		
LOA:	20' 11"	6.25 m		
Beam:	8' 6"	2.44 m		
Keel to Windshield Shelf:	52"	1.32 m		
Total Height:	5' 3"	1.60 m		
Total Height on Trailer	7' 4"	2.24 m		
Transom Angle:	14°	14°		
Deadrise:	19°	19°		
OB Transom Height	25"	64 cm		
Bridge Clearance:	3' 11"	1.19 m		
Cockpit Height (Stern):	31"	79 cm		
Cockpit Height (Helm):	33"	84 cm		
Freeboard (Min):	31"	79 cm		
Draft (Drive Down):	30"	78 cm		
Draft (Drive Up):	13"	33 cm		
Fuel:	50 gal	189 l		
Passengers:	13	13		
Maximum Capacity:	(IO) 2000 lbs (OB) 2950lbs	(IO) 908.5 kg (OB) 1340kg		
POWER RATINGS & WEIGHTS				
Engine Type	Propshaft Power		Boat & Engine Weights	
	HP	KW	LBS	KG
150VX OB	150	112	2980	1350
150FPX OB	150	112	3020	1370
175VX OB	175	131	2980	1350
175FPX OB	175	131	3020	1370
5.0 GL/SX	220	164	3510	1590
5.0 Gi/SX	250	187	3520	1600
5.7GS/SX	250	187	3510	1590
5.7GS/DP (Duoprop*)	250	187	3530	1600
5.7GSi/SX	280	209	3520	1600
5.7GSi/DP (Duoprop*)	280	209	3540	1610
Trailer Weight (Tandem)	1160 LBS-5.0Gi/SX (IO) 1076 LBS-175 HP (OB)		484 KG (IO & OB)	

*Duoprop includes stainless steel propellers.

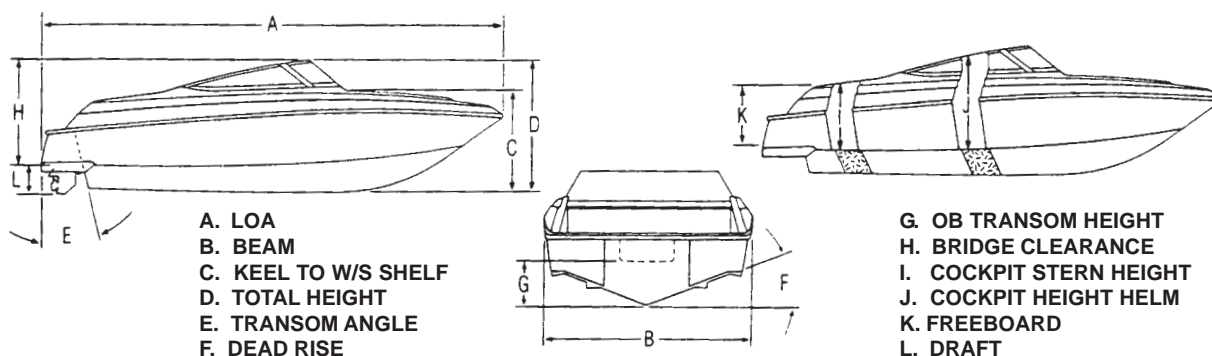

SPECIFICATIONS

234 CANDIA FS				
SPECIFICATIONS:	US	METRIC		
LOA:	22' 6"	6.86 m		
Beam:	8' 6"	2.59 m		
Keel to Windshield Shelf:	57"	1.45 m		
Total Height:	5' 11"	1.80 m		
Total Height on Trailer	7' 9"	2.36 m		
Transom Angle:	13°	13°		
Deadrise:	15°	15°		
Bridge Clearance:	4'9"	1.45 m		
Cockpit Height (Stern):	26"	66 cm		
Cockpit Height (Helm):	31"	79 cm		
Freeboard (Min):	26"	66 cm		
Draft (Drive Down):	32"	81 cm		
Draft (Drive Up):	15"	38 cm		
Fuel:	73 gal	276 l		
Passengers:	13	13		
Maximum Capacity:	1950 lbs	884 kg		
POWER RATINGS & WEIGHTS				
Engine Type	Propshaft Power		Boat & Engine Weights	
	HP	KW	LBS	KG
5.0 GL/SX	220	164	4000	1810
5.0 Gi/SX	250	187	4010	1820
5.7GS/SX	250	187	4000	1810
5.7GS/DP (Duoprop*)	250	187	4020	1820
5.7GSi/SX	280	209	4010	1820
5.7GSi/DP (Duoprop*)	280	209	4030	1830
Trailer Weight (Tandem)	1280 LBS		580 KG	

*Duoprop includes stainless steel propellers.

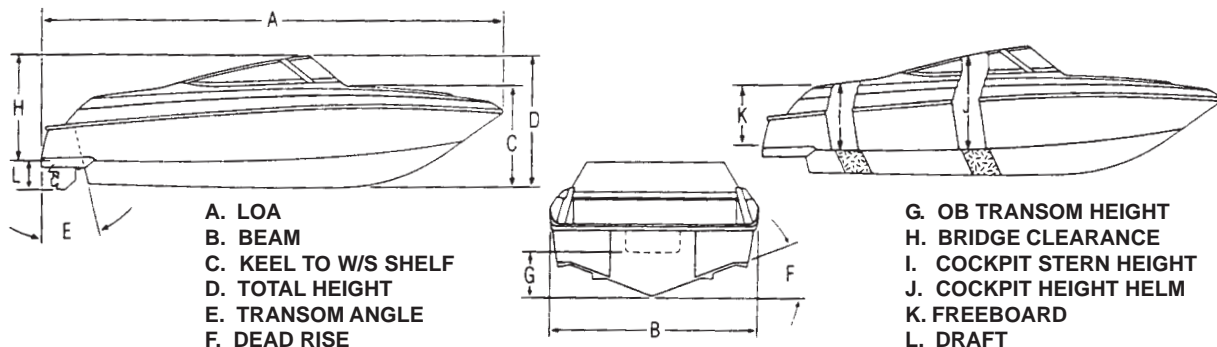

SPECIFICATIONS

254 CANDIA FS				
SPECIFICATIONS:	US	METRIC		
LOA:	25' 6"	7.77 m		
Beam:	8' 6"	2.59 m		
Keel to Windshield Shelf:	60"	1.52 m		
Total Height:	6' 2"	1.88 m		
Total Height on Trailer	7' 11"	2.41 m		
Transom Angle:	14°	14°		
Deadrise:	19°	19°		
Bridge Clearance:	5' 0"	1.52 m		
Cockpit Height (Stern):	26"	66 cm		
Cockpit Height (Helm):	31"	79 cm		
Freeboard (Min):	28"	71 cm		
Draft (Drive Down):	33"	84 cm		
Draft (Drive Up):	16"	41 cm		
Fuel:	73 gal	276 l		
Passengers:	15	15		
Maximum Capacity:	2300 lbs	1040 kg		
POWER RATINGS & WEIGHTS				
Engine Type	Propshaft Power		Boat & Engine Weights	
	HP	KW	LBS	KG
5.7GS/SX	250	187	4370	2070
5.7GS/DP (Duoprop*)	250	187	4590	2080
5.7GSi/SX	280	209	4580	2080
5.7GSi/DP (Duoprop*)	280	209	4600	2090
7.4Gi/DP (Duoprop*)	310	231	4800	2180
Trailer Weight (Tandem)	1650 LBS		782 KG	

*Duoprop includes stainless steel propellers.

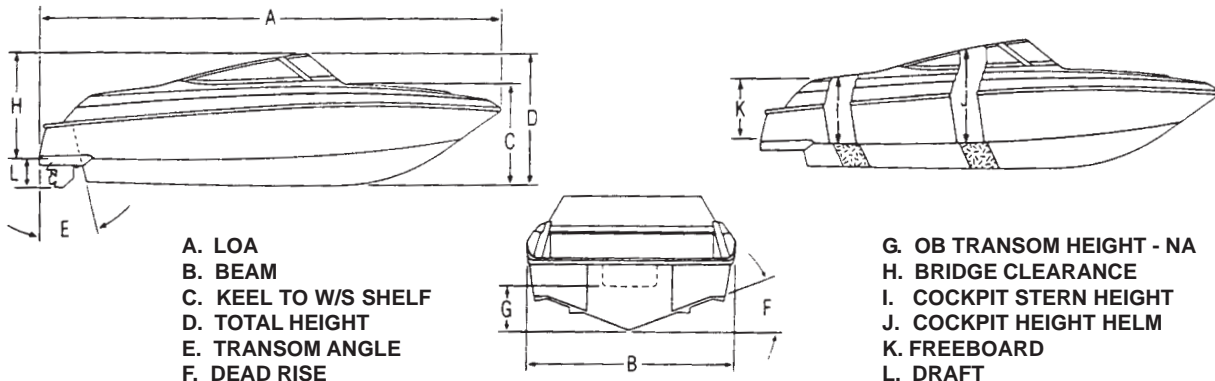

TABLE OF CONTENTS

OPERATION	1
A - 1 GENERAL	1
A - 2 COMPONENT SYSTEMS	1
A - 3 SAFETY EQUIPMENT	1
A - 4 PASSENGER SAFETY	1
A - 5 "RULES OF THE ROAD"	1
A - 6 LIGHTNING	1
A - 7 DRUGS AND ALCOHOL	2
A - 8 PRE-CRUISE SYSTEM CHECK	2
A. Before Starting The Engines	2
B. After Starting The Engine	2
A - 9 ENGINE OPERATIONAL PROCEDURES	2
A. Before Starting	2
B. Cold Engine Start (Carbureted Engines)	3
C. Warm Engine Starting	3
D. Shifting and Control Speed	4
E. Stopping Engine	4
A - 10 GROUNDING AND TOWING	4
A - 11 BOATING EDUCATION	5
A. Boating Courses	5
B. Boating Manuals or Literature	5
C. Charts and Maps	5
SAFETY EQUIPMENT	1
B - 1 GENERAL	1
A. Required Safety Equipment	1
B. Personal Floatation Devices (PFD's)	1
C. PFD Types	1
D. PFD Pointers	2
E. Emergency Stop Switch	2
F. Fire Extinguisher	3
G. Visual Distress Signal Devices	3
H. Sound Signaling Devices	4
I. Navigation Lights	4
J. Additional Recommended Equipment	4
B - 2 CARBON MONOXIDE	4
A. Properties and Characteristics of Carbon Monoxide	5
B. What Makes Carbon Monoxide	5
C. How a Person is Affected by Carbon Monoxide	5
D. Effects of Carbon Monoxide	5
E. Symptoms	5
F. Treatment (Evacuate, Ventilate, Investigate, Take Corrective Action)	6
G. Inspection	6
H. Operation	6
I. Boathouses, Sea Walls and Other Boats	6
J. Backdrafting (Station Wagon Effect)	7

	K.	Cabin Appliances	8
	L.	Ventilation of Accommodation Spaces	8
	M.	Altitude and Sea Conditions	8
	N.	Portable Generator Sets	8
	O.	Maintenance - Engine Performance	8
	P.	Maintenance - External Conditions	9
B - 3		SAFE BOATING PRACTICES	9
	A.	Drugs and Alcohol	9
	B.	Safe Operation	9
	C.	Passenger Safety	9
	D.	Propeller	10
	E.	First Aid	10
	F.	Operation By Minors	10
	G.	“Rules of the Road”	10
	H.	Voluntary Inspection	10
	I.	Safe Boating Courses	10
B - 4		WATER SPORTS	11
	A.	Water Sport Guidelines	11
	B.	Water Skiing	11
BASIC SEAMANSHIP			1
C - 1		GENERAL	
	A.	Boating Regulations	1
	B.	Rules of Seamanship	1
C - 2		NAVIGATIONALAIDS	3
	A.	International Association of Lighthouse Authorities System B (IALA-B)	3
	B.	Lateral Markers	3
	C.	Safe Water Markers	3
	D.	The Uniform State Waterway Marking System	4
	E.	A Special Sign	4
	F.	Noise	4
C - 3		RECOMMENDED READING	4
C - 4		CONTACTS	4
C - 5		OWNER'S LOGS AND RECORDS	5
C - 6		NAVIGATIONALAIDS CHART	5
WARRANTY AND SERVICE			1
D - 1		FOUR WINNS WARRANTY POLICY	1
D - 2		HULL STRUCTURE WARRANTY	1
D - 3		WARRANTY REGISTRATION	1
D - 4		TRANSFER OF WARRANTY	1
D - 5		PRE-OWNED UNIT REGISTRATION	1
D - 6		INSURANCE COVERAGE	2
D - 7		SERIAL NUMBER RECORD	2
D - 8		PRE-DELIVERY SERVICE	2
D - 9		REPLACEMENT PARTS	2
D - 10		WINNGEAR	2

ENGINES AND INSTRUMENTATION	1
E - 1 GENERAL	1
E - 2 ENGINE EXHAUST	1
E - 3 ENGINES	2
E - 4 PROPELLERS	2
A. Diameter	2
B. Pitch	2
C. Prop Slip	2
E - 5 RUNNING ANGLE & POWER TRIM/TILT	3
A. Power Trim	3
B. Power Tilt	3
E - 6 ENGINE INSTRUMENTATION	3
A. Tachometer	4
B. Speedometer	4
C. Temperature Gauge	5
D. Oil Pressure Gauge	6
E. Voltmeter	6
F. Fuel Gauge	6
G. Power Trim Gauge	6
H. Depthsounder - 214 Candia FS I/O & O/B	6
I. Clock and Depthsounder Operation - 1999 VDO Module 234 Candia FS and 254 Candia FS	9
J. Four Winns/VDO Module Display Settings - 2000 234 Candia FS and 254 Candia FS	10
K. Ignition Switch	12
L.. Emergency Ignition Shut-Off	12
M. Engine Hour Meter	13
N. Alarm Systems	13
O. Instrument Maintenance	13
P. VDO Module Quick Start Card	14
CONTROL SYSTEMS	1
F - 1 GENERAL	1
F - 2 CONTROL OPERATION	1
A. Carbureted Engines	1
B. Fuel Injected Engines (EFI)	2
F - 3 NEUTRAL SAFETY SWITCH	2
F - 4 CONTROL SYSTEM MAINTENANCE	2
STEERING SYSTEMS	1
G - 1 GENERAL	1
A. Rotary Steering	1
B. Tilt Steering	1
C. Power Steering	1
D. Hydraulic Steering	2
G - 2 PROPELLER TORQUE	2
G - 3 STEERING SYSTEM MAINTENANCE	3
A. General Maintenance	3
B. Rotary System Maintenance	3
C. Hydraulic System Maintenance	3
D. Winter Storage	3

ELECTRICAL SYSTEMS	1
H - 1 GENERAL	1
H - 2 BATTERY SYSTEM	1
A. Single Battery System	1
H - 3 12 VOLT ELECTRICAL EQUIPMENT	1
A. Helm Equipment	1
B. Installation of Additional 12 Volt Equipment	2
C. Interior Equipment	2
H - 4 ELECTRICAL SYSTEM MAINTENANCE	2
A. Battery Maintenance	2
B. Electrical Wiring Maintenance	3
H - 5 STRAY CURRENT CORROSION	4
A. General	4
B. Galvanic Corrosion	4
C. Corrosion Prevention	4
FUEL SYSTEMS	1
I - 1 GASOLINE FUEL SYSTEMS	1
A. System Testing	1
B. Fuel Fills	1
C. Anti-Syphon Valves	2
D. Fuel Gauge	2
E. Fuel Senders	2
F. Fuel Filters	3
G. Use and Maintenance	3
I - 2 FUEL STANDARDS	3
A. Problems With Alcohol in Gasoline	3
B. Recommendations	4
I - 3 FUELING INSTRUCTIONS	4
WASTE AND WATER SYSTEMS	1
J - 1 GENERAL	1
J - 2 DISINFECTING THE WATER SYSTEM	1
J - 3 FRESH WATER SYSTEM	2
A. Cockpit Sink - Head Sink	2
B. Cockpit Entertainment Center - 254 Candia FS	2
C. Transom Washdown	2
J - 4 HEADS	2
A. Candia FS Enclosed Heads	3
B. Pump Out Option	4
J - 5 SYSTEM MAINTENANCE	4
A. Clean Vents and Screens	4
B. Winterizing the Water System	4
VENTILATION AND DRAINAGE SYSTEMS	1
K - 1 ENGINE COMPARTMENT VENTILATION	1
A. Gravity Ventilation System	1
B. Forced Air Ventilation	1
C. Engine Ventilation System Maintenance	1

K - 2	HULL DRAINAGE SYSTEMS	1
	A. Transom Drain	1
	B. Bilge Pumps	1
	C. Liner Drains	2
	D. Bilge Compartment Drainage	2
INTERIOR EQUIPMENT		1
L - 1	PORT CONSOLE COOLER - 214 CFS	1
L - 2	BUILT-IN ICE CHEST - 234/254 CFS	1
L - 3	ENTERTAINMENT CENTER - 254 CANDIA FS	1
L - 4	HEADS	1
L - 5	STEREO	2
L - 6	CHERRY HELM ENHANCEMENTS	2
L - 7	ANCHOR/LADDER STORAGE	2
L - 8	SKI STORAGE LOCKER	2
L - 9	BOW STORAGE	2
L - 10	BOW FILL-IN CUSHIONS	3
L - 11	STERN SEAT STORAGE	3
L - 12	STARBOARD STORAGE LOCKER	3
L - 13	SWIM PLATFORM - STERN LADDER	3
L - 14	TRANSOM DOOR - SIDE DOOR	4
L - 15	WALK-THROUGH DOOR - 234/254 CFS	4
EXTERIOR EQUIPMENT		1
M - 1	RAILS & DECK HARDWARE	1
	A. Rails	1
	B. Cleats	1
	C. Transom Ski Tow Ring	1
	D. Ski Pylon - 214 CFS Outboard Model	1
	E. Anchor/Ladder Locker	1
	F. Maintenance	2
M - 2	WINDSCREENS & WINDSHIELDS	2
M - 3	SWIM PLATFORM	2
M - 4	TRANSOM DOOR - SIDE DOOR	2
M - 5	ANCHOR	2
M - 6	DEPTHSONDER	3
UPHOLSTERY		1
N - 1	EXTERIOR SEATING	1
	A. Cockpit Tables	1
	B. Bow Table - Optional	1
	C. Bow Seating	1
	D. Helm "Buddy" Seat	2
	E. Bucket Seats	2
	F. L-Shaped Lounger Seating	4
	G. Motorbox (Engine Covers)	4
N - 2	EXTERIOR UPHOLSTERY CARE	5
N - 3	REPLACEMENT UPHOLSTERY	6

N - 4	CARPET CARE	6
	A. Interior and Exterior Carpet	6
	B. Cleaning and Maintenance	6
	C. Stain Removal Testing	6
	D. Stain Removal Procedures	6
WEATHER COVERS		1
O - 1	GENERAL INFORMATION	1
	A. Bimini/Camper Top	1
	B. Forward Cover	2
	C. Cockpit Cover	2
	D. Mooring Cover	2
O - 2	TRAILERING	2
O - 3	WINTER STORAGE	3
O - 4	MAINTENANCE	3
O - 5	CARBON MONOXIDE	3
FIBERGLASS AND HULL INFORMATION		1
P - 1	HULL DESIGN INFORMATION	1
P - 2	FIBERGLASS CONSTRUCTION	1
P - 3	EQUIPMENT INSTALLATION	1
P - 4	FIBERGLASS CARE & MAINTENANCE	2
	A. General Maintenance	2
	B. Weathering Effects on Gel Coat	2
	C. Stains	3
P - 5	FIBERGLASS REPAIRS	3
	A. Scratches	4
	B. Gouges & Blisters	4
	C. Osmotic Blistering	5
P - 6	ANTIFOULING PAINT	5
P - 7	HULL SUPPORT	5
WOODWORK AND COMPOSITES		1
Q - 1	HIGH-PRESSURE LAMINATE CARE	1
Q - 2	STAR BOARD	1
Q - 3	CHERRY ENHANCEMENTS	1
GENERAL MAINTENANCE		1
R - 1	WINTERIZATION	1
	A. Prior to Lifting for Winter Layup	1
	B. After Lifting	1
	C. Prior to Winter Storage	2
R - 2	ENGINE FLUSH OUT	2
R - 3	GENERAL MAINTENANCE SCHEDULE	3

TRAILERS	1
S - 1 GENERAL TRAILER INFORMATION	1
A. Regulations	1
B. Load Carrying Capacity	1
C. Hitches	2
S - 2 TRAILER COMPONENTS	2
A. Bunk Supports	2
B. Tongue	2
C. Swivel Jack	3
D. Coupling Assembly	4
E. Surge Disc Brakes	4
F. Winch	5
G. Wheels	6
H. Spare Tire Carrier	6
I. Lights	7
J. Tie-downs	7
S - 3 OPERATION	8
A. Hitching Trailers	8
B. Backing Up With Surge Disc Brakes	9
S - 4 TRAILERING	10
A. Checklist	10
B. Tactics	10
S - 5 MAINTENANCE	11
A. Care of Exterior Finish	11
B. Bunks	11
C. Swivel Jack	11
D. Brake Actuator & Coupling Assembly	11
E. Winch	11
F. Lights	11
G. Tie-downs	11
H. Wheels	12
I. Brakes	12
J. Bearings	12
S - 6 AXLE INSPECTION & REPAIRS	12
A. Removal of Hub	12
B. Bearing/Seal Inspection and Replacement	13
C. Hub Reinstallation	13
GLOSSARY	1
FLOAT PLAN	1
FUEL LOG	1
SERVICE LOG	1
SERVICE INFORMATION	1
ELECTRICAL SCHEMATICS	1

OPERATION

A - 1 GENERAL

Before starting the boat, become familiar with all of the various systems and related operations. Be sure all necessary safety equipment is on-board. Know the "Rules of the Road". Have an experienced pilot brief you on the general operation of your new boat. Perform a "Pre-Cruise Systems Check". This manual is a part of your boat's equipment. Always keep it on board.

A - 2 COMPONENT SYSTEMS

Before you can really enjoy your boat, a thorough understanding of its systems and their operation is essential. This manual and the associated manufacturers information are included in the owner's packet. This information is provided to enhance your knowledge of the boat. Read this information carefully.

After becoming familiar with the boat and its systems, reread this manual. Maintenance and service tips are included to help keep the boat in like-new condition.

A - 3 SAFETY EQUIPMENT

Besides the equipment installed on the boat by Four Winns, L.L.C., certain other equipment is required for passenger safety. A brochure listing the Federal equipment requirements is included in the owner's packet or is available through your local U.S. Coast Guard Station. Remember that these laws are for your protection and are minimum requirements. Check your local and state regulations, also.

Items like a sea anchor, working anchor, extra dock lines, flare pistol, a line permanently secured to your ring buoy, etc. could at some time save your passengers lives, or save your boat from damage.

The Coast Guard Auxiliary offers a "Courtesy Examination." This inspection will confirm the boat is equipped with all of the necessary safety equipment.

A - 4 PASSENGER SAFETY

You are responsible for the safety of your passengers as well as for their behavior while aboard. Make sure:

1. Each passenger is properly instructed in Personal Flotation Device (PFD) use and keeps one within reach in case of emergency. All non-swimmers and children should wear a PFD at all times when underway.
2. Passengers do not sit on gunwales, open decks, elevated pedestal seats or on seat backs when the boat is underway. This could cause them to be thrown overboard during a sudden maneuver.
3. At least one other person knows how to operate the boat in case of an emergency.

A - 5 "RULES OF THE ROAD"

As in driving an automobile, there are a few rules that must be known if safe boating operation is to be maintained. The Coast Guard, Coast Guard Auxiliary, Department of Natural Resources or your local boat club sponsor courses in boat handling, including "rules of the road". Such courses are strongly recommended. Books on this subject are also available from local libraries.

A - 6 LIGHTNING

When boating, it is important to be aware of the weather around you. When the weather changes for the worse, DO NOT jeopardize your safety by trying to "ride out the storm". If possible, return to safe harbor and dock your vessel immediately.

If caught in a storm, seek shelter inside the cabin and wait for the storm to pass. With open bow models, suntops and campers will provide some protection, but should not be relied on if you are able to return to shore. Exercise care when high winds are present!



WARNING

DO NOT swim or dangle legs or arms into the water during a lightning storm. Stay out of the water!

Lightning will seek a ground when it strikes. Avoid contact with metal parts such as bow rails, control handle, or windshield.

A - 7 DRUGS AND ALCOHOL

Please keep in mind that along with the fun of boating comes responsibility. As the owner or operator of a pleasure boat, you are obligated (morally and legally) to use good judgement while underway in providing for the safety and well-being of your passengers and other boaters around you.

A common and flagrant violation of good judgement and the law by mariners involves the use of alcohol or drugs. Each year, about half of all accidents involving fatalities involve the use of alcohol or drugs.

It is a federal offense to operate a boat while intoxicated. Criminal penalties may include the termination of operating privileges for up to one year. Many states have passed similar laws.

Alcohol or drugs have an inhibiting effect on the judgement and reaction time of the boat operator and his/her passengers. Heed the advice of experts and statisticians...DO NOT drink or use drugs when operating a boat. NEVER allow an obviously intoxicated person to take the helm.

Have fun in your Four Winns® boat but also, have the good sense to be mentally alert and physically capable of operating the boat in a safe manner.

A - 8 PRE-CRUISE SYSTEM CHECK

Before leaving the dock, the following items should be checked:

A. Before Starting The Engine

1. Check the weather forecast. Determine if the cruise planned can be made safely.

2. Be sure all necessary safety equipment is on board and operative. This includes items such as the running lights, horn, spotlight, life saving devices, etc.
3. Check the bilge water level and bilge pump operation. Check the engine and drive fluid levels. Look for other signs of potential problems. Check for the scent of fuel fumes.
4. Activate the Bilge Blower. Check the blower output.



WARNING

Gasoline vapors can explode resulting in injury or death. Before starting the engine, check engine compartment bilge for gasoline or vapors. Operate blower for four minutes, and verify blower operation. ALWAYS run the blower when the vessel is operating below cruising speed.

5. Ensure an adequate amount of fuel is on board.
6. Be sure you have sufficient water and other provisions on board for the cruise planned.
7. Leave a written message listing details of the planned cruise with a close friend ashore.

B. After Starting The Engine

1. Visibly check the engine to be sure there are no apparent water or oil leaks.
2. Check the gauges. Make sure the oil pressure, water temperature, voltmeter, etc. are reading normally.
3. Have a safe cruise and enjoy yourself.

A - 9 ENGINE OPERATIONAL PROCEDURES

A. Before Starting

1. Check the engine compartment for water, gas, and/or oil leaks of any kind. Keep the bilge in a clean condition to prevent blower and bilge pump damage, and fire hazards.
2. Check the fluid levels of the engine oil and power steering system daily. Fill oil or steering fluid as required by the indications on the dip sticks. Refer to the Table 1: "SAE Viscosity Chart" and your engine manual included in the owner's packet. DO NOT USE MULTIGRADE OIL. Power steering and power

trim use automatic transmission fluid. Check the fluid levels in the vertical drive units or transmission as often as practical.

IF THE LOWEST ANTICIPATED TEMPERATURE IS*	THE FOLLOWING SAE VISCOSITY OILS ARE RECOMMENDED
32° F (0° C) and above	SAE 30
0° F (-18° C) to 32° F (0° C)	SAE 20W-20
Below 0° F (-18° C)	SAE 10W

*Temperature range you expect to operate.
Note: Use only single viscosity oils.

Table 1: SAE Viscosity Chart

3. Start and operate the bilge blower system for at least four (4) minutes before start-up.
4. Lower the vertical outdrive units (on applicable models) making sure the water intakes are under the water.

B. Cold Engine Start (Carbureted Engines)

1. The engine may require priming prior to starting. To prime the engine, proceed as follows:
 - a. Place ignition switch in the OFF position.
 - b. Disengage shift mechanism.
 - c. Move control handle to the full throttle position; this operates accelerator pump and primes the engine.
 - d. Repeat priming, if necessary.
 - e. Return the control handle to fast idle position.
2. Turn key switch to START position and hold until engine starts. DO NOT hold in START position for more than ten seconds. In colder weather, more priming may be necessary. However, too much priming may flood engine.

If engine floods:

- Disengage shift. Move handle to full throttle position.
- Turn key switch to the START position.
- Immediately move the control handle to the idle position when the engine starts.

NOTICE

Failure to move the control handle to the idle position immediately when engine starts will allow engine to “over-rev” and engine damage could result. “Over-revving” engine after off-season storage could also damage the water pump impeller. **When starting engine for the first time after off-season storage, always idle engine for one minute to allow the water pump to prime.**

3. As soon as engine starts:
 - a. Release key to the ON or RUN position.
 - b. Move control handle to the fast idle position to warm up engine. DO NOT exceed 1000 RPM.

NOTICE

Cold engine starting procedures are different for EFI engines. Priming is not necessary. Refer to the engine owner’s manual for additional information.

C. Warm Engine Starting

1. Move control handle to the neutral detent position.
2. Turn key switch to START position and hold until engine starts, but DO NOT hold in start position for more than ten seconds. If engine does not start, let go momentarily, then try again.
3. As soon as engine starts, release key to the ON or RUN position.

NOTICE

NEVER turn key to START position when engine is running.

NOTICE

Warm engine starting procedures are different for EFI engines. Refer to the engine owner’s manual for additional information.

D. Shifting and Control Speed

NOTICE

If your boat is equipped with a non-OEM remote control system, ask your dealer how to properly operate it.

1. Move control handle to the neutral detent (idle) position. This will engage neutral start switch and allow engine to start.

 **CAUTION**

DO NOT shift into FORWARD or REVERSE unless engine is running. Damage to the shift system could result from trying to shift without the engine running. Carefully check function of all control and engine systems before leaving the dock.

2. To go FORWARD - actuate the neutral lock mechanism and briskly move the shift handle forward. Throttle movement will begin after forward gear engagement.
3. To go in REVERSE - actuate the neutral lock mechanism and briskly move the shift handle rearward. Throttle movement will begin after reverse gear engagement.

 **WARNING**

DO NOT shift from forward to reverse when the boat is planing.

NOTICE

DO NOT shift if engine speed is above 800 RPM.

4. To go from FORWARD to REVERSE, or REVERSE to FORWARD; always pause at NEUTRAL and allow engine speed to return to idle.
5. After shifting is completed, continue to move the control handle slowly in the desired direction to increase speed.

 **WARNING**

Any time the boat is operated, be aware of changes in shift system operation. A sudden increase in shift effort at the remote control handle, or other abnormal operation, indicates a possible problem in the shift system. If this occurs, the following precautions must be taken:

- With engine running and boat securely tied to the dock, shift drive into forward and reverse to ensure there is gear engagement.
- When docking the boat, all docking maneuvers must be performed at slow speed. Pay special attention to other boaters. Passengers should be informed of potential problems and precautions taken.

If you suspect there is a problem, see your Volvo Penta dealer as soon as possible for proper diagnosis and required service or adjustment. Continued operation could result in damage to the shift mechanism and loss of control.

E. Stopping Engine

1. Move control handle to the NEUTRAL position.
2. Turn ignition key to the OFF position.

NOTICE

DO NOT stop engine at speeds above idle or “speed up” engine while turning off ignition. Engine damage could result.

A - 10 GROUNDING AND TOWING

 **WARNING**

If the boat should become disabled, or if assisting another craft that is disabled, great care must be taken. The stress applied to a boat during towing may become excessive. Excessive stress can damage the structure of the boat and create a safety hazard for those aboard.

Four Winns® boats are not designed nor intended to be used as a towing vessel. The mooring cleats on Four Winns® boats are not designed or intended to be used for towing purposes. These cleats are specifically designed as mooring cleats for securing the boat to a dock, pier, etc. DO NOT use these fittings for towing or attempting to free a grounded vessel.

Freeing a grounded vessel or towing a boat that is disabled requires specialized equipment and knowledge. Line failure and structural damage caused by improper towing have resulted in fatal injuries. Because of this, Four Winns strongly suggests that these activities be left to those who have the equipment and knowledge such as the U.S. Coast Guard, to safely accomplish the towing task.

 **CAUTION**

Running aground can cause serious damage to a boat and associated underwater gear. If the boat should become grounded, distribute personal flotation devices and inspect the boat for possible damage. Thoroughly inspect the bilge area for signs of leakage. An experienced service facility should check the hull and underwater gear at the first opportunity. DO NOT continue to use the boat if the condition of the hull or underwater equipment is questionable.

If towing or being towed is absolutely necessary, use the strongest lines available, and attach them to the bow eyes or stern eyes only. Have all passengers slip on life jackets and take a seat in the cabin or other protected area.

 **WARNING**

Lines can snap or other hardware can be loosened or broken while towing. Under certain conditions, this can cause severe injury or fatality.

A - 11 BOATING EDUCATION

A. Boating Courses

Boating education classes are offered throughout the country. The United States Coast Guard Auxiliary offers free courses on different topics usually during the off-season. The most popular course is the “Boating Skills & Seamanship Course,” and information can be obtained by calling 1-800-336-BOAT.

The United States Power Squadron also offers free courses ranging from basic seamanship to celestial navigation. For information, contact your local Power Squadron, or write: U.S.P.S., P.O. Box 30423, Raleigh, NC 27622.

The Red Cross offers power boating and canoeing classes. Contact: Director of Water Safety, American National Red Cross, 17th & D Streets N.W., Washington, DC 20006.

The Canadian Power and Sail Squadron offers seamanship courses. Information can be obtained by calling 1-800-268-3579 (Canada only).

B. Boating Manuals or Literature

A good source of information is the U.S. Coast Guard’s home study book called “The Skipper’s Course”. This book may be purchased through: Superintendent of Documents, U.S. Government Printing Office, Washington, DC 20402, Stock # 050-012-00159-6.

Another good source of boating information is Chapman’s “Piloting, Seamanship and Small Boat Handling”. Also, check the local library or bookstore for additional information on boating.

C. Charts and Maps

U.S. nautical charts are sold throughout the country at Governmental Printing Office stores and other agents. A chart catalog is available by writing to: National Oceanic and Atmospheric Administration, National Ocean Survey, Rockville, MD 20852.

In addition, many federal agencies publish recreational maps, including the U.S. Army Corp of Engineers, the Forest Service, the National Park Service, and the Tennessee Valley Authority.

Addresses of all state boating agencies are listed in “A Boater’s Guide”. For a free copy, write to: National Marine Manufacturers Association, 401 N. Michigan Avenue, Chicago, IL 60611.

SAFETY EQUIPMENT

B - 1 GENERAL

As the owner/operator of the boat, you are responsible for assuring that all required safety equipment is aboard. You should also consider supplying additional equipment as needed for your safety and that of your passengers. Check state and local regulations and call the U.S. Coast Guard Boating Safety Hotline at 1-800-368-5647 for information about required safety for information about required safety equipment.

A. Required Safety Equipment

Most of the safety equipment required by federal regulations is provided as standard equipment. Personal Floatation Devices (life jackets) must fit the person wearing it. If local regulations require additional equipment, it must be approved by the U.S. Coast Guard (USCG). Minimum requirements include the following:

- Personal Floatation Devices
- Visual Distress Signal
- Bell or Whistle
- Fire Extinguisher
- Navigation Lights

B. Personal Floatation Devices (PFD's)

Federal regulations require that you have at least one Coast Guard approved personal floatation device (PFD) for each person in a recreational boat. You should not use your boat unless all PDFs are in serviceable condition, readily accessible, legibly marked with the Coast Guard approval number, of an appropriate size (within the weight range and chest size marked on the PDF) for each person aboard.

A PFD provides buoyancy to help keep your head above the water and to help you remain in a satisfactory position while in the water. Body weight and age should be considered when selecting a PFD. The buoyancy provided by the PFD should support your weight in water.

The size of the PFD should be appropriate for the wearer. Body weight or chest size are common methods used to size PFDs. It is your responsibility to ensure that you have the proper number and types of PFD's on board and that your passengers know where and how to use them.

C. PFD Types

Five types of PFDs have been approved by the U.S. Coast Guard. The PFDs are described as follows:

PFD Type 1, Wearable (Figure B1) has the greatest required buoyancy. Its design allows for turning most unconscious persons in the water from face down position to a vertical or slightly backward, face-up position. It can greatly increase the chances of survival. Type 1 is most effective for all waters, especially offshore when rescue may be delayed. It is also the most effective in rough waters.

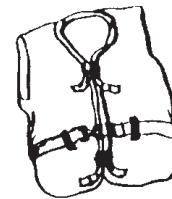

Figure B1: Type I, Wearable

PFD Type II, Wearable (Figure B2) turns its wearer in the same way as Type I, but not as effectively. The Type II does not turn as many persons under the same conditions as a Type I. You may prefer to use this PFD where there is a probability of quick rescue such as in areas where other people are commonly involved in water activities.

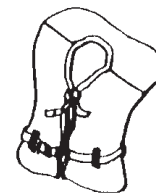

Figure B2: Type II, Wearable

PFD Type III, Wearable (Figure B3) allows the wearer to place themselves in a vertical or slightly backward position. It does not turn the wearer. It maintains the wearer in a vertical or slightly backward position and has no tendency to turn the wearer face down. It has the same buoyancy as a Type II PFD and may be appropriate in areas where other people are commonly involved in water activities.



Figure B3: Type III, Wearable

PFD Type IV, Throwable (Figure B4) is required in addition to the PFDs previously discussed. The most common Type IV PFD is a buoyant cushion or ring buoy. It is designed to be thrown to a person in the water, grasped and held by the user until he or she is rescued. A Type IV PFD should always be in serviceable condition and immediately available for use. Grasping this PFD may be difficult if the rescue is delayed or if the user is overcome by hypothermia (loss of body heat).



Figure B4: Type IV, Throwable

PFD Type V, Wearable (Figure B5) when inflated, it provides buoyancy equivalent to Type I, II, or III PFDs. When it is deflated, however, it may not support some people.



Figure B5: Type V, Wearable

D. PFD Pointers

The purpose of a PFD is to help save your life. If you want it to support you when you are in the water, it needs to fit, float, and be in good condition.

1. Try the PFD on and adjust it until it fits comfortably in and out of the water. Mark your PFD if you are the only wearer.

2. To make sure the PFD works, wear it in the water. This will show you how it works and give you confidence when you use it.
3. Teach children how to put a PFD on and allow them to try it in the water. That way, they know what the PFD is for and how it works. They will feel more comfortable with it if they suddenly find themselves in the water.
4. If the PFD is wet, allow it to dry thoroughly before storing it. Do not dry it in front of a radiator or heater. Store it in a well ventilated area.
5. Keep PFDs away from sharp objects which can tear the fabric or puncture the floatation pads.
6. For their own safety and the safety of others, all nonswimmers, poor swimmers, and small children should wear PFD's at all times, whether the boat is stationary or moving.
7. Check the PFD frequently to make sure that it is not torn, that floatation pads have no leaks, and that all seams and joints are securely sewn.
8. If a PFD contains kapok, the kapok fibers may become waterlogged and lose their buoyancy after the vinyl inserts are punctured. If the kapok becomes hard or if it is soaked with water, replace it. It may not work when you need it.

E. Emergency Stop Switch

This safety device automatically stops the engine if the lanyard is attached to the operator and the operator falls from his work station. Refer to the engine manual for detailed information about using this switch.

The emergency stop switch (Figure B6) incorporates a shutoff switch, switch clip, lanyard, and lanyard clip. The lanyard clip must be securely attached to the operator's PFD, clothing, arm, or leg. Be sure to attach the lanyard to a place where it is free of obstructions and to something that will move with the operator if he or she leaves the helm station. If the engine shuts down because this switch was activated, the clip may have to be reinstalled on the interrupter switch before the engine can be started.

WARNING

Keep emergency stop switch lanyard free from obstructions that could interfere with its operation. Do not modify or remove emergency stop switch or bypass its safety features. The proper use of the emergency stop switch will prevent a runaway boat situation which can cause severe personal injury or death.

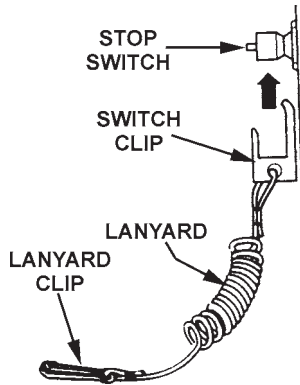

Figure B6: Emergency Stop Switch

F. Fire Extinguisher

As the owner/operator of the boat, you are responsible for supplying a fire extinguisher approved by the U.S. Coast Guard.

NOTICE

As the owner/operator of the boat, you are responsible for assuring that all required safety equipment is aboard and meets the boating regulations as prescribed by both federal and local authorities in your area.

Hand-held portable extinguisher(s) should be mounted in a readily accessible location(s) away from the engine compartment. All persons aboard should know the location(s) and proper operation of the fire extinguisher(s).

WARNING

Fire!

In case of fire do not open the engine compartment. Shut down engine(s), generator(s), and blower(s). Discharge entire contents of fixed fire suppression system, if equipped. If using portable CO2 fire extinguisher continuously discharge entire contents. On European models, discharge contents through fire port.

NOTICE

Using a portable fire extinguisher with an access/fire port in the engine compartment is preferred to opening the engine compartment to fight the fire. However, using a portable extinguisher in this way provides less protection against fire than a fixed suppression system.

NOTICE

Do not test fire extinguishers by squirting small amounts of the extinguishing compound. The fire extinguisher might not work when you really need it.

The Candia Funship models are considered to be Class 1 powerboats (16 to less than 26 feet). Since they have permanently installed fuel tanks, they are required to carry one (1) B-1 type hand portable fire extinguisher. If the boat is equipped with a fixed fire extinguishing system in the engine compartment, one (1) B-1 type hand portable fire extinguisher is still required.

G. Visual Distress Signal Devices

Visual distress signal devices approved by the U.S. Coast Guard are required on all recreational boats operating on coastal waters and to boats owned in the United States when they are operating on the high seas. Coastal waters include territorial seas and those waters directly connected to the Great Lakes and the territorial seas up to a point where the waters are less than two miles (3.2km) wide. Visual distress signal equipment may be of the pyrotechnic or non-pyrotechnic type. Regulations prohibit display of visual distress signals on the water under any circumstances except when assistance is required to prevent immediate or potential danger to persons on board a vessel.

The equipment must be approved by the U.S. Coast Guard, be in serviceable condition, and be stowed in a readily accessible location. Equipment having a date for serviceable life must be within the specified usage date shown. Careful selection and proper stowage of visual distress equipment is very important if young children are aboard.

DAY USE ONLY	NIGHT USE ONLY	DAY AND NIGHT USE
Three orange smoke signals (one hand held and two floating) or one orange flag with black square and disk.	One S-O-S electric distress light.	Three flares of the hand held, meteor or parachute type.

Distress Signal Table

The minimum visual distress signals required in coastal waters for a Class 1 powerboat is the following:

One orange flag with black square-and disc (daytime); and an S-O-S electric light (night-time); or three orange smoke signals, hand held or floating (daytime); or three red flares of hand held, meteor, or parachute type (daytime/night-time).

NOTICE

No single signaling device is appropriate for all purposes. Consider keeping various types of equipment on board.

H. Sound Signaling Devices

Class 1 powerboats (16 to less than 26 feet) are required to carry a hand, mouth or power operated horn or whistle. It must produce a blast of two-second duration and audible at a distance of at least one-half (1/2) mile.

The following are standard whistle signals:

- One Prolonged Blast Warning Signal
- One Short Blast Pass on my Port Side
- Two Short Blasts Pass on my Starboard Side
- Three Short Blasts Engines in Reverse
- Five or More Blasts Danger Signal

I. Navigation Lights

Navigation lights are intended to keep other vessels informed of your presence and course. If you are out on the water between sunset and sunrise, you are required to display appropriate navigation lights.

J. Additional Recommended Equipment

Four Winns® recommends that you acquire additional equipment for safe, enjoyable cruising. This list, which is not all inclusive, includes items you should consider acquiring.

Basic Gear

- | | | |
|--|---------------------|---------------|
| Flashlight | Spare batteries | Tow line |
| Oar, paddle | Mooring lines | Compass |
| Dock fenders | Distress signals | First aid kit |
| Boat hook | VHF radio | EPIRB* |
| Sunscreen | Extra warm clothing | Charts |
| Second anchor & line | | |
| Dewatering device (pump or bailer) | | |
| Emergency supply of drinking water and food. | | |
- *Emergency Position Indicating Radio Beacon

Tools

- | | | |
|-------------------|-----------------|-----------------|
| Spark plug wrench | Hammer | Screwdriver |
| Jackknife | Pliers | Electrical tape |
| Adjustable wrench | Lubricating oil | Prop wrench |
| Duct tape | | |

Spare Parts

- | | | |
|-----------------------|-------------|-------------|
| Extra bulbs | Spare prop | Extra fuses |
| Extra drain plug | Spark plugs | Spare wire |
| Extra prop nut/washer | | |

Gear For Extended Cruises

- | | | |
|---|-----------------|----------|
| Foul weather gear | Parallel rulers | Dividers |
| Loran or Global Positioning System navigation equipment | | |

B - 2 CARBON MONOXIDE



Carbon Monoxide!

Carbon monoxide (CO) can be harmful or fatal if inhaled. Brain damage or death can occur if exposed to carbon monoxide. Keep exhaust outlets clear of blockage. Provide adequate ventilation. Open hatches, doors, windows and vents to insure adequate ventilation. Close engine compartment doors and hatches when engine or generator is running. Avoid operating the boat for extended periods of time at idle speed, and be sensitive to weather conditions that may prevent CO from dissipating into the air. (See Preface for actual warning label regarding carbon monoxide.)

Carbon monoxide accumulation is affected by vessel geometry; hatch, window and door openings; ventilation openings; proximity to other structures; wind direction; vessel speed; and a multitude of other variables. The technical information included in this section is to inform the boat owner of possible cause and effects of carbon monoxide. This information has been reprinted with permission from the American Boat and Yacht Council's (ABYC) technical information report: "Educational Information About Carbon Monoxide". This information pertains to all boats manufactured by Four Winns®.

NOTICE

The boat owner should be aware that other factors may contribute to carbon monoxide accumulation. The most common ones are listed in this section. If a person is exhibiting carbon monoxide-type symptoms (Refer to B-2E Symptoms), be sure to take the necessary precautions as prescribed later in this section.

NOTICE

Boats fueled by diesel have limited carbon monoxide present in the exhaust in comparison to gasoline engine exhaust. However, the boat owner should still be aware of the causes and effects of carbon monoxide which may occur in different boating situations.

A. Properties and Characteristics of Carbon Monoxide

1. Carbon Monoxide is a colorless, odorless and tasteless gas. It is commonly referred to as CO.
2. Its weight is about the same as air so it cannot be expected to rise or fall like some other gases, but will distribute itself throughout the space.

NOTICE

DO NOT rely on the use of smell or sight of other gases to detect CO, because it diffuses in the air much more rapidly than easily detectable (visible and odorous) gases.

B. What Makes Carbon Monoxide

Any time a material containing carbon burns such as gasoline, natural gas, oil, propane, coal, or wood, CO is produced.

Common sources of carbon monoxide are:

1. Internal combustion engines.
2. Open flame devices such as:
 - a. Cooking ranges
 - b. Central heating plants
 - c. Space heaters
 - d. Water heaters
 - e. Fireplaces
 - f. Charcoal grills

C. How a Person is Affected by Carbon Monoxide

Carbon monoxide is absorbed by the lungs and reacts with blood hemoglobin to form carboxyhemoglobin, which reduces the oxygen carrying capacity of the blood. The result is a lack of oxygen for the tissues with the subsequent tissue death and, **if prolonged, death of the individual.**

D. Effects of Carbon Monoxide

Carbon monoxide in high concentrations can be fatal in a matter of minutes. Lower concentrations must not be ignored because the effects of exposure to CO are cumulative and can be just as lethal.

Certain health related problems and age will increase the effects of CO. People who smoke or are exposed to high concentrations of cigarette smoke, consume alcohol or have lung disorders or heart problems, are particularly susceptible to an increase in the effects from CO. However, all occupants' health should be considered. Physical exertion accelerates the rate at which the blood absorbs CO.

E. Symptoms

One or more of the following symptoms can signal the adverse effect of CO accumulation:

1. Watering and itchy eyes
2. Flushed appearance
3. Throbbing temples
4. Inattentiveness
5. Inability to think coherently
6. Ringing in the ears
7. Tightness across the chest
8. Headache
9. Drowsiness

10. Incoherence
11. Nausea
12. Dizziness
13. Fatigue
14. Vomiting
15. Collapse
16. Convulsions

NOTICE

The order of the above list is generally the sequence of appearance of symptoms. However, the order of appearance may change for different people.

NOTICE

The symptoms of Carbon monoxide poisoning may easily be mistaken for seasickness.

F. Treatment (Evacuate, Ventilate, Investigate, Take Corrective Action)

1. Move the person to fresh air.
2. Administer oxygen if available.
3. Contact Medical help.
4. If the victim is not breathing, perform artificial respiration per approved CPR procedures until medical help arrives and takes over.

NOTICE

Prompt action can make the difference between life and death.

5. Ventilate area.
6. Investigate source of CO and take corrective action.

G. Inspection

Look and listen for leaks in the exhaust systems of both the generator and propulsion engine(s). Look for discoloration around joints in the system (water leaks, carbon, stains, etc.).

1. Make sure all exhaust clamps are in place and secured.
2. Make sure ventilation systems work and are not obstructed or restricted.

3. Make sure gaps around the engine room plumbing and cableways and exhaust system doors, hatches, and access panels are minimized to reduce the opportunity for CO to enter the accommodation space(s).

H. Operation

Cold Start vs. Warm Start: CO production is greater while the combustion chamber surfaces and gas passages are cold versus when they are warm. A boat operator should:

1. Pay attention to ventilating the boat.
2. Orient the boat so it will allow the maximum dissipation of CO.
3. Minimize the time spent on getting underway.



DANGER

The following are examples of possible situations where carbon monoxide can accumulate within your boat while docked, anchored, or underway. Become familiar with these examples and their precautions to prevent **dangerous** accidents or death.

I. Boathouses, Sea Walls and Other Boats

A boat operator should be aware that dangerous concentrations of CO can accumulate when a boat, generator or other engine operated device is operated while the boat is moored in a confined area such as:

1. Boathouses,
2. Proximity to sea walls, or
3. Proximity to other boats.

Orient the boat for maximum dissipation of the exhaust or **DO NOT** run the boat or boat equipment for extended periods under these conditions. See Figure B7.

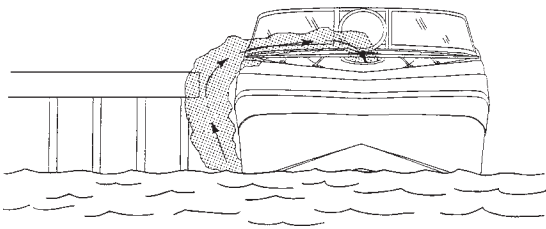

Figure B7: The effect of sea walls and other confined spaces.

A boat operator should be aware that carbon monoxide is emitted from any boat's exhaust. The operation, mooring, and anchoring in an area containing other boats may be in an atmosphere containing CO not of the operator's making. An operator likewise needs to be aware of the effect of his actions on other boats. Of prime concern is the operation of an auxiliary generator with boats moored along side each other. Be aware of the effect your exhaust may have on other vessels and be aware that the operation of other vessel's equipment may affect the carbon monoxide concentration on your vessel. See Figure B8.

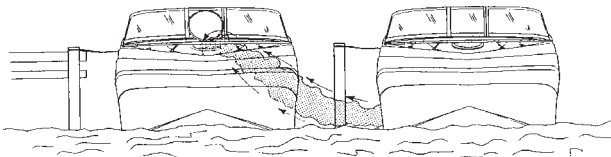

Figure B8: The effect of boats moored along side.

J. Backdrafting (Station Wagon Effect)

Backdrafting or the "station wagon effect" is caused by air movement over or around a boat creating a low pressure area of suction area around the stern which can increase CO level on the boat. Backdrafting can be affected by relative wind direction, boat speed, and boat trim angle. See Figure B9 Backdrafting - Airflows Over Boat and Behind Transom".

Under certain speed and operating conditions the low pressure area may form in other regions and permit carbon monoxide to enter the hull through openings that are not on the back of the vessel. Boat factors which may affect CO concentration:

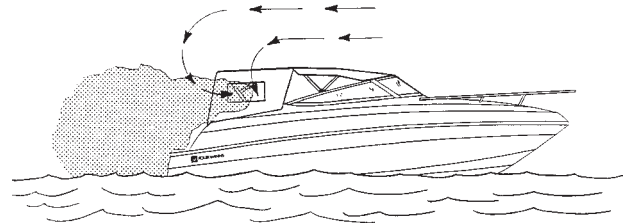

Figure B9: Backdrafting - Air flows over boat and behind transom.

1. Inefficient trim angle. See Figure B10.
2. Excessive or unequally distributed weight.

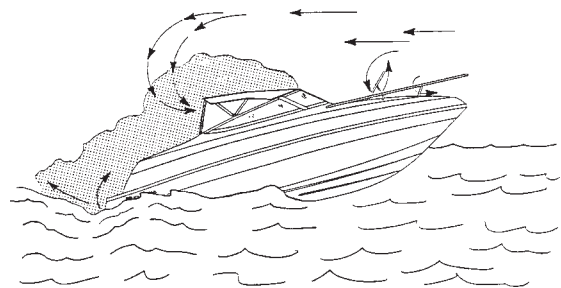

Figure B10: Inefficient trim angles.

3. Canvas Configurations - Under various conditions, adding or removing canvas may raise or lower CO levels. See Figures B9, B10 & B12.



Exhaust Fumes!

Hull exhaust from your boat can cause excessive accumulation of poisonous carbon monoxide gas within cockpit areas when using protective weather coverings (while underway or while stationary). Provide adequate ventilation when the canvas top, side curtains and/or back (aft) curtains are in their closed protective positions. (See Preface for actual warning label regarding carbon monoxide and weathering cover/canvas.)

4. Opening and closing ports, hatches, doors, and windows may raise or lower CO levels on board a boat. See Figures B11 and B12.

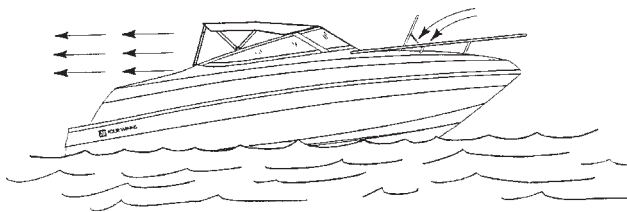

Figure B11: Desired air flow through the boat.

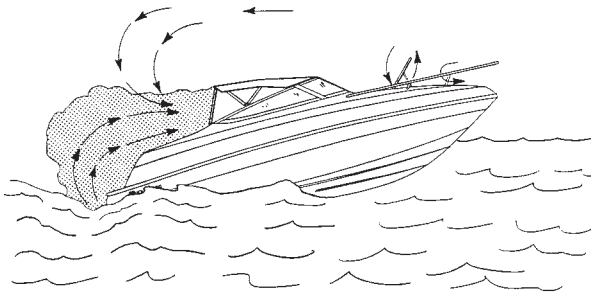

Figure B12: The effect of canvas configurations.

K. Cabin Appliances

Boats having fuel burning appliances in accommodation areas should be provided with adequate ventilation and maintained to function properly.

L. Ventilation of Accommodation Spaces

Accommodation spaces need to be ventilated to introduce fresh air into the spaces. Ventilation method; e.g. windows, hatches, doors, and blowers; used to accomplish this may, under certain conditions, bring hazardous levels of CO into the accommodation spaces. Care should be taken to be aware of all prevailing conditions when using these ventilating methods.

M. Altitude and Sea Conditions

Changes in altitude greater than 5,000 feet contribute to inefficient engine performance and may require adjustments to the ignition systems, fuel systems, or changing the propeller's size.

1. Failure to make adjustments to ignition systems, fuel systems, and propeller size may cause an increase in CO production.
2. Heavy sea conditions tend to load engines resulting in reduced performance and thereby increasing their CO production.

N. Portable Generator Sets

Gasoline powered portable generators are available in the marine market place and are not an option available through Four Winns®. Portable generators will produce CO. These sets discharge their exhaust products in locations which can lead to an increase in the accumulation of carbon monoxide in the accommodation space. This equipment is not recommended for use on Four Winns® boats.

O. Maintenance - Engine Performance

Efficient engine performance is vital to minimizing CO production. The following items are those considered to have the greatest effect on increased CO production:

1. Fuel Systems - Fuel that is contaminated, stale or incorrect octane number.
 - a. Dirty or clogged flame arrester.
 - b. Malfunctioning automatic choke plate or faulty adjustment of manual choke plate.
 - c. Worn float needle valve and seat.
 - d. High float level.
 - e. Incorrect idle mixture adjustment.
 - f. Dirty or worn injectors.
3. Ignition System
 - a. Fouled or worn spark plugs.
 - b. Worn points or incorrect gap on points.
 - c. Shorted or opened circuit high tension spark plug cables.
 - d. Incorrect ignition timing.
4. General
 - a. Worn piston rings and valves.
 - b. Engine temperature - Cold running engines increase CO production. Engine cooling water system design and selection of thermostat(s)

are primary considerations affecting engine operating temperature. Generally, an engine produces less CO if it operates at a relatively high temperature within manufacturer's specifications.

- c. Exhaust Back-Pressure - Certain alterations to the exhaust system may increase engine exhaust back pressure and CO production.
- d. Restricted engine room or compartment ventilation.

P. Maintenance - External Conditions

External conditions that contribute to inefficient engine performance are:

- 1. Fouled hull bottom.
- 2. Damaged and fouled running gear (propeller and trim tabs).
- 3. Incorrect selection of propeller size.

B - 3 SAFE BOATING PRACTICES

<p>NOTICE</p> <p>YOU are responsible for your own safety, the safety of your passengers, and the safety of fellow boaters.</p>
--

A. Drugs and Alcohol

 <p>WARNING</p> <p>Alcohol consumption and boating do not mix! Operating under the influence endangers the lives of your passengers and other boaters. Federal laws prohibit operating a boat under the influence of alcohol or drugs.</p>

Do not use drugs or drink alcohol while operating a boat. Like driving a car, driving a boat requires sober, attentive care. Operating a boat while intoxicated or under the influence of drugs is not only dangerous, but it is also a Federal offense carrying a significant penalty. These laws are vigorously enforced. The use of drugs and alcohol, singly or in combination, decreases reaction time, impedes judgement, impairs vision, and inhibits your ability to operate a boat.

B. Safe Operation

Safe operation means that you do not misuse your boat nor do you allow your passengers to do so. Safe operation means using good judgement at all times. It includes, without limitation, the following actions:

- Observe all safety signs and warnings both inside the boat and in the immediate boating area.
- Become familiar with, and adhere to, the "Rules of the Road".
- Maintain boat speed at or below the legal limits. Avoid excessive speed or speeds not appropriate for operating conditions.
- Be sure at least one other passenger is familiar with the operation and the safety aspects of the boat in case of an emergency.
- Load the boat within the limits listed on the capacity plate. Balance loads bow and stern and port to starboard.
- Do not use the boat in bad weather or sea conditions beyond the skill or experience of the operator or the comfortable capability of the boat or passengers.
- Make sure the passengers and gear do not obstruct the operator's view or impede his ability to move.
- Do not exceed the maximum engine power rating stated on the certification plate located inside the boat.

C. Passenger Safety

Before getting underway, show all passengers where emergency and safety equipment is stowed, and explain how to use it. Everyone aboard should wear rubber-soled shoes which resist slipping on wet surfaces. While underway, passengers should remain seated inside the deck rails and gates. Do not allow passengers to drag their feet or hands in the water. Always use handholds and other safety hardware to prevent falls. All nonswimmers, poor swimmers and small children should wear PFD's at all times.

D. Propeller



Personal Injury!

Do not allow anyone near a propeller, even when the engine is off. Propeller blades can be sharp and continue to turn even after the engine is shut off. Do not allow anyone near the propeller when the throttle is in neutral position. Accidentally engaging the shift can result in a serious injury or death. (See actual ladder warning labels and helm boarding ladder warning label below.)



Never approach or use ladder when motor is running. Severe injury or death will result from contact with rotating propeller.

Ladder Warning Label



Shut off motor when near swimmers. Severe injury or death will result from contact with rotating propeller.

Helm Boarding Ladder Warning Label



When pulling skiers do not turn on the engine until you are at least a boat length away. When approaching a downed skier, turn off the engine at least one boat length away before reaching the skier in the water.

E. First Aid

As a boater, you should be familiar with the basic first aid procedures that may be needed while you are out far from help. Fish hook accidents or minor cuts and abrasions may be the most serious mishaps on board a boat but you should also learn the proper procedures and be ready to deal with the truly serious problems like mouth-to-mouth resuscitation, excessive bleeding, hypothermia, and burns. First aid literature and courses are available through most Red Cross chapters.

F. Operation By Minors

Minors should always be supervised by an adult whenever operating a boat. Many states have laws regarding the minimum age and licensing requirements of minors. Be sure to check local laws or contact the state boating authorities for information.

G. "Rules of the Road"

As a responsible boater, you must comply with the "Rules of the Road," the marine traffic laws enforced by the U.S. Coast Guard. Navigating a boat is much the same as driving an automobile. Operating either one responsibly means complying with a set of rules intended to prevent accidents. Just as you assume other car drivers know what they are doing, other boaters assume you know what you are doing. Information regarding navigational rules and the "Rules of the Road" are discussed in further detail in C-1 & C-2 of the next section.

H. Voluntary Inspections

State boating officials in many states or the U.S. Coast Guard Auxiliaries offer courtesy inspections to check out your craft. They will check for compliance with safety standards and required safety equipment. You may voluntarily consent to one of these inspections, and you are allowed to make corrections without prosecution. Check with the appropriate state agency or the Coast Guard Auxiliary for details.

I. Safe Boating Courses

The local U.S. Coast Guard Auxiliary and the U.S. Power Squadrons offer comprehensive safe boating classes several times a year. You may contact the Boat/U.S. Foundation at 1-800-336-BOAT (2628) or, in Virginia, 1-800-245-BOAT (2628) for a course scheduled in your area. Also contact the U.S. Coast Guard Auxiliary or Power Squadron Flotilla for the time and place of their next scheduled class.

B - 4 WATER SPORTS

 **WARNING**

Personal Injury!

Four Winns® boats are not designed for and should not be used for pulling parasails, kites, gliders or any device which can become airborne. Use boat only for appropriate water sports. (See Preface for actual warning label.)

Water skiing, kneeboarding, or riding a towed, inflatable apparatus are some of the more popular water sports. Taking part in any water sport requires increased safety awareness by the participant and the boat operator. If you have never pulled someone behind your boat before, it is a good idea to spend some hours as an observer, working with and learning from an experienced driver. It is also important to be aware of the skill and experience of the person being pulled. Always have a second person on board to observe the person in the water so the driver can concentrate on operating the boat.

A. Water Sport Guidelines

Everyone participating in a water sport should observe these guidelines:

1. Allow only capable swimmers to take part in any water sport.
2. Always wear a personal flotation device (PFD) approved by the U.S. Coast Guard. Wearing a properly designed PFD helps a stunned or unconscious person stay afloat.
3. Be considerate of others you share the water with.
4. Give immediate attention to a person who has fallen. He or she is vulnerable in the water alone and may not be seen by other boaters.
5. Approach a person in the water from the lee side (opposite the direction of the wind). **Turn off the motor at least a boat length from the person.**
6. Turn engine off and anchor before swimming.
7. Always participate in water sports in safe areas. Stay away from other boats, beaches, restricted areas, swimmers and heavily traveled waterways.

8. Swim only in areas designated as safe for swimming. These are usually marked with a swim area buoy (see Figure B13). Do not swim alone or at night.



Figure B13: Swim Area Buoy

 **WARNING**

Rotating Propeller!

Rotating propeller can cut or sever causing serious injury or death. Shut engine off and remove ignition key when anyone is swimming nearby. (See Section B-3D.)

9. Do not allow anyone near the propeller(s), even when the engine is off. Propeller blades are sharp and can continue to turn even after the engine is off. Stay at least 150 feet away from areas marked by diver down float. See Figure B14.



Figure B14: Diver Down Float

10. Do not drive the boat directly behind a water skier. At 25 miles per hour, the boat will overtake a fallen skier who was 200 feet in front in about 5 seconds.

B. Water Skiing

The popular sport of water skiing has brought a special set of safety precautions to observe in boating. The following guides help prevent accidents while water skiing.

1. Water ski only in safe areas, away from other boats and swimmers, out of channels, and in water free of underwater obstructions.

2. Allow no one who can not swim to water ski. Skiers must wear a USCG approved floatation device. A Type III water-ski vest is an approved and practical PFD.
3. Have a second person aboard to observe the skier and inform the driver about the skier's hand signals (Figure B15). The driver must give full attention to operating the boat and the waters ahead.
4. Give immediate attention to a fallen skier. Be careful not to swamp the boat while taking the skier on board.
5. Always participate in water sports in safe areas. Stay away from other boats, beaches, swimmers, and heavily traveled waterways.
6. Be considerate of others you share the water with.
7. Give immediate attention to a person who has fallen. He or she is vulnerable in the water alone and may not be seen by other boaters.
8. Approach a person in the water from the lee side (opposite the direction of the wind). Stop the motor at least a boat length from the person.
9. Turn off engine and anchor your boat before swimming.



WARNING

Rotating Propeller!

Rotating propeller can cut or sever causing serious injury or death. Switch engine off before skiers enter the water and before taking skiers aboard. **Do not leave engine running in neutral.** Accidentally engaging shift can seriously injure skier.

10. Do not water ski between sunset and sunrise. It is illegal in most states.

For more information about water skiing, please contact the American Water Ski Association, 799 Overlook Drive, Winter Haven, FL. 33884 or call 1-800-533-2972.

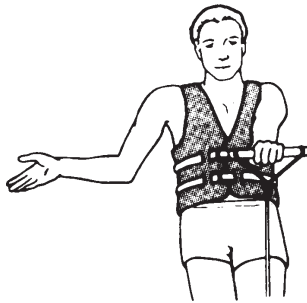

FASTER—
Palm of one hand pointing upward.

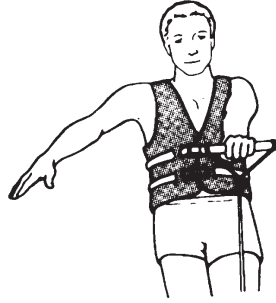

SLOWER—
Palm pointing down.



SPEED OK—
Arm upraised with thumb and finger joined to form circle.

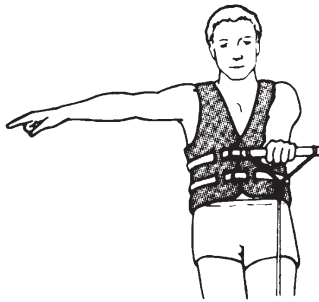

RIGHT TURN—
Arm outstretched pointing to the right.

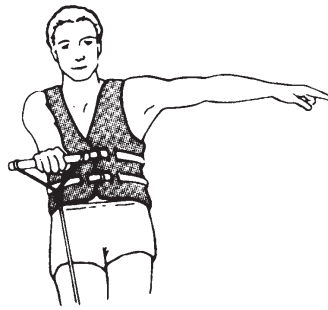

LEFT TURN—
Arm outstretched pointing to the left.



RETURN TO DROP-OFF AREA —
Arm at 45 degree from body pointing down to water and swinging.



CUT MOTOR—
Finger drawn across throat.



STOP—
Hand up, palm forward, policeman style.



SKIER OK. AFTER THE FALL—
Hands clenched together overhead.

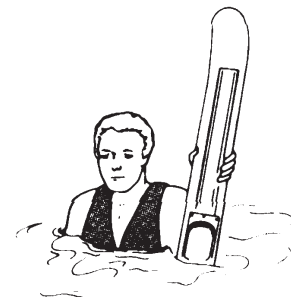

PICK ME UP OR FALLEN SKIER, WATCH OUT—
One ski extended vertically out of water.

Figure B15: Skiing Signals

BASIC SEAMANSHIP

C - 1 GENERAL

Basic rules of seamanship, general information about navigational aids, and sources for additional reading and boater education are presented in this portion of your owner's manual.

A. Boating Regulations

The U.S. Coast Guard is the authority of the waterways. State boating regulations are enforced by local authorities. Your boat is subject to the marine traffic laws known as "Rules of the Road," which are enforced by the U.S. Coast Guard. You are subject to marine traffic laws and "Rules of the Road" for both federal and state waterways; you must stop if signaled to do so by enforcement officers, and permit them to board if asked. The "Rules of the Road" can be obtained from the local U.S. Coast Guard Unit or the United States Coast Guard Headquarters by calling (202) 512-1800 or faxing your request to (202) 512-2250, and asking for the publication titled "Navigational Rules, International-Inland.

Many pamphlets prepared by the Coast Guard are available. They explain signal lights, buoys, safety, international and inland regulations and other information which goes beyond the scope of this manual. "Aids to Navigation" (U.S. Coast Guard pamphlet #123) explains the significance of various lights and buoys. Because of proposed alterations to buoys and markers, contact the U.S. Coast Guard to stay informed of changes. Other pamphlets, including the "Boating Safety Training Manual" and "Federal Requirements For Recreational Boats," are also available from the U.S. Coast Guard Headquarters.

NOTICE

The spoken word "**MAYDAY**" is the international signal for distress. "**MAYDAY**" should **NEVER** be used unless there is grave or imminent danger, and you are in need of immediate assistance.

B. Rules of Seamanship

1. Right-of-way

In general, boats with less maneuverability have right-of-way over a more agile craft. You must stay out of the way of the following vessels:

A vessel not under command or aground.	These vessels have no maneuverability.
A vessel restricted in its maneuverability.	These vessel are performing work which limits their maneuverability such as surveying, dredging, laying pipe or cable, servicing navigational markers among others.
A vessel engaged in fishing.	These include boats fishing with lines, trawl or nets; but not trolling lines.
Sailboats	Sailboats have the right-of-way over power boats; however, if a sailboat is using a propeller to move forward, it is considered a power boat even if its sails are up.

2. Meeting Head-On

When two boats meet head-on neither boat has right-of-way. Both boats should decrease speed and pass; port to port. However, if both boats are on the left side of a channel, each vessel should sound two short horn blasts and pass to starboard to starboard. See Figure C1.

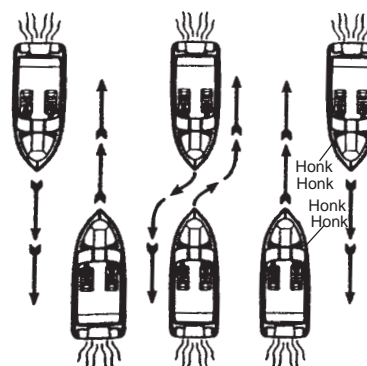

Figure C1: Meeting Head-On

3. Crossing Situations

In a crossing situation, the boat on the right from the 12-4 o'clock position has the right-of-way. It must hold course and speed. The boat without the right-of-way must keep clear and pass to the stern. See Figure C2.

Stand-on (Privileged) Vessel holds course and speed.

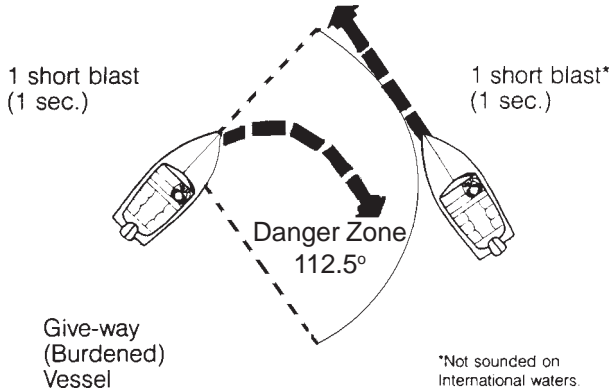

Figure C2: Crossing Situation

4. Overtaking

The boat overtaking the one ahead must yield the right-of-way to the boat being passed. The overtaking boat must make necessary adjustments to keep out of its path. The boat being passed should hold its course and speed. See Figure C3.

Inland Rules

"I want to pass you on your port side."

2 short blasts (1 sec.)

"Proceed"

2 short blasts (1 sec.)

International Rules

"I am altering my course to port."

2 short blasts (1 sec.)

International Rules in Narrow Channels

"I intend to pass you on your port side."

2 prolonged blasts (4-6 sec.)
2 short blasts (1 sec.)

"Proceed."

1 prolonged, 1 short
1 prolonged, 1 short

Inland Rules

"I want to pass you on your starboard side."

1 short blast (1 sec.)

"Proceed"

1 short blast (1 sec.)

International Rules

"I am altering my course to starboard."

1 short blast (1 sec.)

International Rules in Narrow Channels

"I intend to pass you on your starboard side."

2 prolonged blasts (4-6 sec.)
1 short blast (1 sec.)

"Proceed."

1 prolonged, 1 short
1 prolonged, 1 short blast

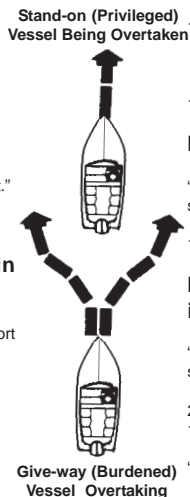

Figure C3: Overtaking

5. The General Prudential Rule

The general prudential rule regarding right-of-way is that if a collision appears unavoidable, neither boat has right-of-way. As prescribed in the "Rules of the Road", both boats must act to avoid collision.

6. Night Running

Boats operating between sunset and sunrise (hours vary by state), or in conditions of reduced visibility, must use navigational lights. Nighttime operation, especially during bad weather or fog, can be dangerous. All "Rules of the Road" apply at night, but it is best to slow down and stay clear of all boats regardless of who has right-of-way.

To see more easily at night, avoid bright lights when possible. Also, it is helpful to have a passenger keep watch for other boats, water hazards, and navigational aids.

To determine the size, speed and direction of other vessels at night, you should use running lights. A green light indicates the starboard side, and the red light indicates the port side. Generally, if you see a green light, you have the right-of-way; if you see a red light, give way to the other vessel. See Figure C4.

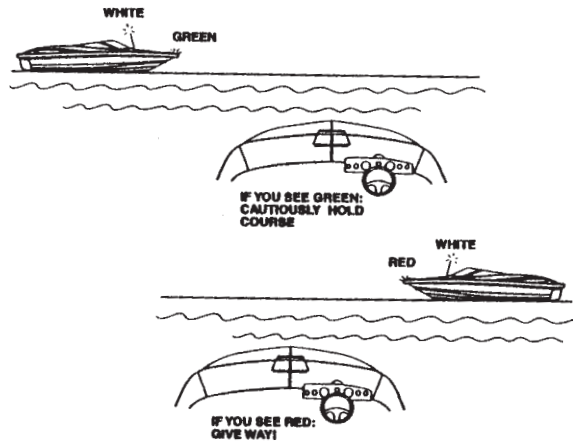

Figure C4: Night Running

7. Whistle Signal

Out on the water, whistle signals are commonly used. Although using a whistle signal is not necessary every time a boat is nearby, operators must signal their intentions when necessary to avoid potentially confusing or

hazardous situations. Use whistle blasts early enough to be noticed and understood by other boaters.

It is customary for the privileged boat to signal first and the yielding boat to return the same signal to acknowledge she understands and will comply. Use the danger signal (five or more short and rapid blasts) if intent is not clear. A short blast is one or two seconds long. A long blast is 4 to 6 seconds long. The Navigational Aids Chart at the end of this section lists the meanings of the various whistle signals.

C - 2 NAVIGATIONAL AIDS

Aids to navigation (ATONS) help you to travel safely on the water. They help you get from one place to another and are most helpful if you have a nautical chart. A navigational aids chart is at the end of this section.



WARNING

NEVER tie your vessel to an ATON. It is illegal because it blocks the ATON from view of other boaters. Decreased visibility can contribute to a serious accident which may result in property damage, personal injury, or death.

There are two ATON systems. The system used on federal waters is known as the International Association of Lighthouse Authorities System B (IALA-B). The Coast Guard maintains this system. The second system is the Uniform State Waterway Marking System (USWMS). This system is maintained by state authorities.

A. International Association of Lighthouse Authorities System B (IALA-B)

IALA-B uses four types of ATONS. This section discusses the two most common markers: lateral markers and safe water markers. Other federal markers include special markers and isolated danger markers. The Navigational Aids Chart at the end of this section shows these aids.

B. Lateral Markers

Lateral markers indicate the sides of navigable channels. They consist of lighted can or nun buoys and daymarks. Each has a number and is either red or green. The numbers on the green markers are odd. Red markers have even numbers.

Buoys are red or green floating ATONS. If lighted, they have either red or green lights. Unlighted green buoys, called cans, look like cylinders. Unlighted red nun buoys have a cone shaped top with their points cut off. Do not pass too close to a buoy. You may foul the propeller in its chain.

NOTICE

Buoys are anchored floating objects and may not always be in exactly the same position.

Daymarks are red or green boards with numbers. They are on posts or groups of pilings tied together and called dolphins. Daymarks and their supports are daybeacons. Daybeacons may or may not have lights. If a red or green daybeacon has a light, it is the same color as the marker-red or green. Red daymarks are triangular and have even numbers. Green daymarks are square and have odd numbers.

Red, Right, Returning is a basic rule to assist you in using lateral markers. When you are returning from seaward, keep red markers on the starboard (right) side when you pass them. Keep green markers to the port side.

Returning from seaward is very clear if you have been on the ocean. You are returning to port. By agreement, going upstream on a navigational river is returning from seaward. The outlet ends of the Great Lakes are also the seaward ends. Traveling from a large body of water to a smaller one is considered returning from seaward.

C. Safe Water Markers

Safe water markers have vertical red and white stripes and mark the center of navigable channels and fairways. Safe water markers included both lighted and unlighted buoys and daymarks. If a marker is lighted, the light is white and flashes the letter "A" in Morse Code.

Preferred Channel markers have horizontal red and green bands. If lighted, the color of the light is the same as the top of the band. They show the preferred channel for you to use at a junction point. Be sure to notice the color of the top of the band, and treat it as any other marker you would of that color. If the band is red and you are returning from seaward, keep the marker to the right.

Most lights on markers flash on and off. Others such as lights on aids with no lateral significance are fixed.

They stay on all night. ATON lights flash in regular patterns. For example, they may flash every three seconds, or in groups such as two flashes and a pause. There are a number of flashing patterns, which help you identify the light at night. To identify a light, note its color and pattern or timing of flashes, and compare it to your chart to find its location.

D. The Uniform State Waterway Marking System

This section discusses three kinds of markers in this system: Regulatory, Informational, and Lateral.

Regulatory markers in this system are either signs or buoys. Signs are square with orange borders. Regulatory buoys are white and shaped like cylinders. They have horizontal orange bands near their tops and just above the water's surface. An orange circle on a marker means a controlled area. A message such as "No Wake, Idle Speed, No Skiing, or 5 M.P.H." may appear on a marker. An orange diamond means danger. If a diamond has an orange cross inside it, do not enter the area. The reason you should stay out, such as "Swim Area" may be printed in black on the marker.

Informational Markers are white signs with orange borders. They give information such as direction, distance, and location.

Lateral markers in the USWMS system are either numbered red or black buoys. Black buoys may have green reflectors or lights. They are the equivalent of green buoys in the IALA-B system. Red buoys may have red reflectors or lights. They are the same as red buoys in the IALA-B system. Red or black buoys are usually found in pairs - pass between them.

E. A Special Sign

In Florida, you may see a special sign: "Caution, Manatee Area". When you see this sign, slow down to idle speed. Manatees, an endangered species, are passive, large, slow-moving mammals. Many Manatees are seriously injured or killed each year by boat propellers.

F. Noise

Always be aware of local laws on noise limits. Noise means engine noise, radio noise or even yelling by people on your boat. Good seamanship demands that you operate your boat quietly so as not to infringe on the rights of others. Do not use thru-hull exhaust unless you are well offshore.

C - 3 RECOMMENDED READING

We recommend that you read the boating literature published by your state boating agency and the U.S. Coast Guard. Other suggested reading includes the following:

Damford, Don. Anchoring. (ISBN 0-915160-64-1). Seven Seas.

United States Coast Guard Auxiliary. Boating Skills and Seamanship. LC74-164688.(illus.). (ISBN 0-930028-00-7). U.S. Coast Guard.

Bottomley, Tom. Boatman's Handbook, (illus.). 316 p. (ISBN 0-688-03925-1, Hearst Marine Book). Morrow.

Whiting, John and Bottomley, Tom. Chapman's Log and Owner's Manual. 192 p.(ISBN 0-686-96737-2). Hearst Marine Book.

Chapman, Charles F. and Maloney, E.S. Chapman's Piloting, Seamanship and Small Boat Handling. (illus.). 62 p. (ISBN 0-87851-814-2, Pub. by Hearst Bks.); deluxe ed. (ISBN 0-87851-815-0). Morrow.

National Fire Protection Association. Fire Protection Standard for Pleasure and Commercial Motor Craft. (ISBN 0-317-07388-5, NFPA 302). National Fire Protection Association.

Brotherton, Miner. Twelve- Volt Bible. (ISBN 0-915160-81-1). Seven Seas.

C - 4 CONTACTS

There are many good boating publications that have information about your area and what other boats are doing, such as clubs and other activities. Education programs are sponsored by publications and organizations such as the U.S. Power Squadron, U.S. Coast Guard Auxiliary and the American Red Cross. See your dealer about special courses available in the area. For detailed information contact:

American Red Cross
Local address (see local telephone directory)

Boat U.S. Foundation for Boating Safety Hotline
1-800-336-BOAT
1-800-245-BOAT (in Virginia)

U.S. Coast Guard Info Line
1-800-368-5647

NMMA Sources of Waterways Information - National Marine Manufacturers Association has five (5) booklets which list sources for safety, cruising, and local waterway information. Each covers a different region of the U.S. (North Central, South Central, Northeastern, Southeastern and Western). For single copies, write Sources of Waterways information, NMMA, 401 N. Michigan Avenue, Chicago, Illinois 60611. Ask for the booklet for your region.

Skippers Course
GPO Superintendent of Documents
Washington, DC 20012
202-512-1800
202-512-2250 (fax)

United States Coast Guard Auxiliary
Local Flotilla or contact appropriate Coast Guard
District Headquarters

United States Coast Guard Headquarters
2100 2nd St., SW
Washington, D.C. 20593-0001
202-267-1060

United States Power Squadron
P.O. Box 30423
Raleigh, NC 27617

C - 5 OWNER'S LOGS AND RECORDS

At the end of this owner's manual are several forms which you will find very helpful.

The **Float Plan** provides a record of your destination, departure and return times, boat description, passenger list, and other information about the trip you have planned. At the bottom of the form is space for listing emergency telephone numbers in case your return is delayed past the expected time. It also has space for indicating information about the person filing this report. Leave the completed form ashore with a responsible person. We recommend you make several copies of this form each boating season to assure an ample supply.

The **Fuel Log** is a handy way to record information covering engine hours, fuel consumption, miles traveled, as well as RPM (revolutions per minute), average M.P.H. (miles per hour) and GPH (gallons per hour).

The **Service/Maintenance Log** provides a record of maintenance work completed, the date of completion, and the engine hour reading. This log also helps you identify the frequency of routine maintenance work, such as engine oil changes. If you should decide to sell your boat, it demonstrates to perspective buyers that you have done a good job taking care of it.

The **Service Information Sheet** allows you to record all the pertinent information regarding your Four Winns® boat. This sheet will be extremely helpful when ordering additional/optional parts for your boat or when having service work done.

C - 6 NAVIGATIONAL AIDS CHART

The illustrated Navigational Aids Charts contain information concerning whistle signals, storm warnings, bridge signals, and buoy descriptions. See Figure C5 and Figure C6 on the following page.

Navigational Aids Chart

REMEMBER THESE RULES

- OVERTAKING - PASSING:** Boat being passed has the right-of-way. **KEEP CLEAR.**
- MEETING HEAD ON:** Keep to the right.
- CROSSING:** Boat on right has the right-of-way. Slow down and permit boat to pass.

← PORT

Yield right-of-way to boats in your DANGER ZONE!

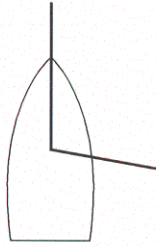

STARBOARD →

DANGER ZONE
(Dead ahead to 2 points abeam your starboard beam)

STORM WARNINGS



RED FLAG
Small craft
(winds to 33 knots)



2 RED FLAGS
Gale
(winds up to 47 knots)



SQUARE RED FLAG BLACK BOX
(Storm)



2 SQUARE RED FLAGS BLACK BOX
(Hurricane)

WHISTLE SIGNALS

ONE LONG BLAST: Warning signal
(Coming out of slip)

ONE SHORT BLAST: Pass on my port side

TWO SHORT BLASTS: Pass on my starboard side

THREE SHORT BLASTS: Engine(s) in reverse

FOUR OR MORE BLASTS: Danger signal

BRIDGE SIGNALS

SOUND

VESSEL: Open

BRIDGE: OK

No

VESSEL: Replies:

RADIO: VHF CH. 13

VISUAL

VESSEL: Open

BRIDGE: OK

DAY (Flag)
NIGHT (Lights)

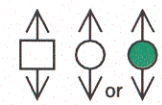

Same or Same

No

LATERAL AIDS AS SEEN ENTERING FROM SEAWARD

PORT SIDE ODD NUMBERED AIDS

GREEN LIGHT ONLY

FLASHING

OCCULTING

QUICK FLASHING

ISOPHASE

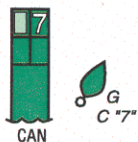
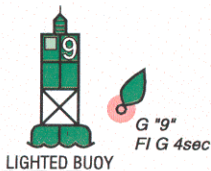

SAFE WATER MID-CHANNELS OR FAIRWAYS NO NUMBERS — MAY BE LETTERED

WHITE LIGHT ONLY MORSE CODE

Mo (A)

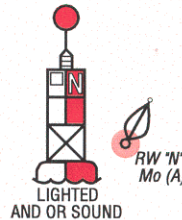

PREFERRED CHANNEL

COMPOSITE GROUP FLASHING (2 + 1)

GREEN LIGHT ONLY

RED LIGHT ONLY

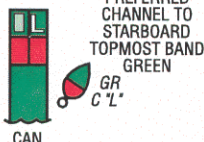
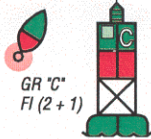

LIGHTED

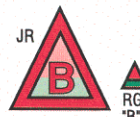
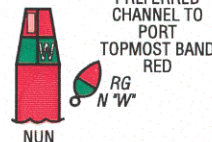
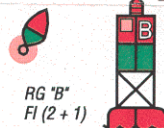

STARBOARD SIDE EVEN NUMBERED AIDS

RED LIGHT ONLY

FLASHING

OCCULTING

QUICK FLASHING

ISOPHASE

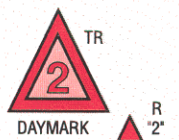
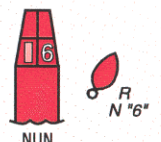
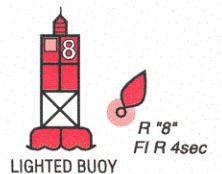

WARRANTY AND SERVICE

D - 1 FOUR WINNS® WARRANTY POLICY

The Four Winns® Winning Edge™ Owner Protection Plan, provides the new Four Winns® purchaser with one of the most comprehensive corporate commitments in the marine industry today. The Four Winns® Owner Protection Plan, defines the warranty coverage on all units manufactured by Four Winns®. It thoroughly describes the warranty policies and those procedures to be followed to obtain warranty coverage. Review the Four Winns® Owner Protection Plan and limited warranty statements carefully.

All engines utilized in the Four Winns® product are warranted by the engine manufacturer. Your Four Winns® dealer is authorized to repair your engines and will work closely with the manufacturer to resolve any problems you have.

D - 2 HULL STRUCTURE WARRANTY

Each unit manufactured by Four Winns® is encompassed by a separate warranty providing specific coverage on the hull structure. The Four Winns® Owner Protection Plan thoroughly describes this coverage.

D - 3 WARRANTY REGISTRATION

A Four Winns® Warranty Registration Card is attached to the Four Winns® Owner Protection Plan statement. Your Four Winns® Dealer is responsible for completing and mailing the warranty card at the time of purchase. This is the sole basis for establishing proof of ownership of the boat and corresponding warranty validation. Registration of the boat and engines with the manufacturer is required by the Federal Boat Safety Act of 1971.

Other equipment manufacturers also require that their products be registered with the respective companies. The warranty registration card is provided in the owner's information packet.

D - 4 TRANSFER OF WARRANTY

Four Winns® confidence in the product and our warranty commitments can extend after the original purchaser may choose to move on to a new boat. Four Winns® Warranty coverage is transferable to successive owners of the boat. Registration of the second or successive owners is required. The Four Winns® Owner Protection Plan thoroughly describes the action required to transfer warranty coverage.

D - 5 PRE-OWNED UNIT REGISTRATION

Section B-4 Transfer of Warranty discussed the need to properly register the purchase of a pre-owned boat with Four Winns® to transfer applicable warranty coverage.

Purchasers of all Pre-Owned Four Winns® models are encouraged to register ownership with Four Winns®. To register ownership of a "Pre-Owned Four Winns® boat," provide Four Winns® with your name, address, daytime phone number, purchase date, and hull serial number of the boat purchased.

If you wish to transfer warranty, be sure to include a check to cover the necessary fee. The amount of the transfer fee is \$50.00. You can send the check to Four Winns® and we will notify the engine manufacturer, Volvo Penta, of the engine warranty transfer.

The hull serial number plate is permanently affixed to the starboard side of the transom.

Registration of a Pre-Owned Four Winns® boat does not extend or in any way affect or modify the specific terms of the Four Winns® Owner Protection Plan or Limited Warranties.

We provide this service to the purchasers of Pre-Owned Four Winns® boats in the interest of better boating. Four Winns® welcomes every purchaser of a Four Winns® boat, new or used, to our family.

D - 6 INSURANCE COVERAGE

One of your responsibilities as a new boat owner is to acquire proper insurance protection. Insurance should include comprehensive and general liability coverage appropriate to your financial needs. Please contact your local agent for assistance on insurance coverage.

D - 7 SERIAL NUMBER RECORD

The manufacturer, model, and serial number of major components are recorded during the assembly of each Four Winns® boat. Two copies of this completed form are included at the end of this section. One copy should be removed and kept by the dealer in his records. This can assist the dealer in processing warranty claims, or obtaining necessary information. The second copy should be kept in this owners manual.

D - 8 PRE-DELIVERY SERVICE

Four Winns® makes every effort to deliver your boat in “turn key” condition to the dealer. The process of transporting and handling the boat necessitates certain inspections and adjustments prior to delivery to you. Also, various aspects of operation must be checked and adjusted immediately prior to final delivery and use.

The selling Four Winns® dealer must perform this thorough review of the boat and its numerous systems during the commissioning or “dealer pre-delivery service” of the craft.

A Four Winns® Pre-Delivery Inspection Form is part of the Warranty Registration Card. It lists the many items encompassed by the pre-delivery service previously described. The dealer is to check off the items as they are completed, and complete the form as indicated providing specific performance related information appropriately.

Your Four Winns® dealer will sign the Pre-Delivery Inspection Form of the Warranty Registration Card upon completion of the work. You will also be asked to sign the Pre-Delivery Inspection Form upon accepting delivery of the boat. You are to retain the two copies marked “Boat Owner”. Your dealer is to retain the copy marked “Dealer copy” for his records. The Manufacturer’s copy is to be mailed to the Four Winns® Customer Service Department.

D - 9 REPLACEMENT PARTS

Four Winns® dealers are equipped with a Four Winns® Parts Manual that details the components of each model and their appropriate part numbers. Many Four Winns® dealers inventory common replacement components.

In addition, Four Winns® maintains specific records on the components used in the manufacture of each unit and makes a concerted effort to maintain components specifically to fill replacement part needs.

The Four Winns® dealer from whom you purchased your boat is in the best position to meet your needs. If he does not have the needed item, he has the capability, through direct contact with the Four Winns® Customer Service Department, to obtain it quickly. Four Winns® will only sell replacement parts to established Four Winns® dealers. If you relocate and cannot find a Four Winns® dealer close to you, contact the Four Winns® Customer Service Department for information on the nearest dealer in your area.

D - 10 WINNGEAR™

Show your colors! Four Winns® offers a complete line of sports clothing designed to complement your new boat. Your Four Winns® dealer has a complete catalog and pricing.

ENGINES AND INSTRUMENTATION

E-1 GENERAL



WARNING

DO NOT attempt to service any engine without being totally familiar with the safe and proper service procedures. Do not attempt to maintain or adjust an engine while it is running. Certain moving parts are exposed and failing to shut off the engine can result in serious injury or death.

Four Winns® does not manufacture engines. Because of the technical nature of the engines, all manufacturers of these items require that warranty and service problems be taken directly to an authorized dealer for resolution. The Four Winns® dealer from whom you purchased your boat will handle all warranty and service matters with the engine manufacturer for you.

In compliance with the Federal Boat Safety Act of 1971, all engine manufacturers require their products to be registered. A registration card is furnished with each new engine. When selling a Four Winns® boat, the dealer, along with the purchaser, should complete the information requested on these cards and return them to the respective engine manufacturers. Engine registration cards are provided with the engine and will usually be found with the owner's information packet.

Each manufacturer of the various marine power components provides an owners information manual with their product. This publication is included with this manual. It is important that you read the manual(s) carefully and become completely familiar with proper care and operation of the engine system. Be sure to read the section on winterization. Replacement costs associated with frozen engine components are quite substantial.

Also review the other sections in this manual, especially Sections I on Fuel Systems, and Section F on Control Systems.

E-2 ENGINE EXHAUST

The carbon monoxide in exhaust fumes can be hazardous. It is important for you and your passengers to be aware of the potential safety hazard created by exhaust fumes. Familiarize yourself with the symptoms of individuals overcome by carbon monoxide, and most importantly, ways you can protect yourself and your guests.



WARNING

DO NOT inhale exhaust fumes! Exhaust contains carbon monoxide which is colorless and odorless. Carbon monoxide is a dangerous gas that is potentially lethal.

Persons overcome by carbon monoxide may exhibit the following symptoms:

- a. Watering and itchy eyes
- b. Flushed appearance
- c. Throbbing temples
- d. Inattentiveness
- e. Inability to think coherently
- f. Ringing in the ears
- g. Tightness across the chest
- h. Headache
- i. Drowsiness
- j. Incoherence
- k. Nausea
- l. Dizziness
- m. Fatigue
- n. Vomiting
- o. Collapse
- p. Convulsions

IF YOU THINK EXHAUST FUMES ARE ENTERING YOUR BOAT, DETERMINE THE CAUSE AND HAVE IT CORRECTED IMMEDIATELY!

The following suggestions can help prevent exhaust fumes from entering the boat:

1. DO NOT allow the boat to remain stationary with the engine running for an extended period of time.

2. Use extreme caution while operating the engine in confined areas such as enclosed slips or congested piers. Operation under such conditions could easily lead to exhaust gasses (carbon monoxide) entering even though you may have all the hatches, windows, doors and portholes closed.
3. Persons sleeping can be easily overcome by carbon monoxide because they are unaware of its presence. Sleeping while the engine is running is not recommended. If persons are sleeping aboard while underway, those awake should monitor for carbon monoxide accumulation in the cabin; especially the sleeping areas.

 **WARNING**

NEVER operate the propulsion engine while everyone on-board is sleeping. Fatal carbon monoxide poisoning can occur.

For additional information, refer to Section B-2 Carbon Monoxide.

E - 3 ENGINES

Consult the Engine Owners Manual included in the owner's packet for additional operation and maintenance information.

E - 4 PROPELLERS

Knowledge of the propeller is most easily gained through better understanding of the terminology used to refer to the aspects of propeller size and performance.

NOTICE

Never run with a damaged propeller. You can damage the engine or drive unit. Keep a spare propeller on board.

A. Diameter

Diameter is twice the distance from the center of the prop shaft to the extreme tip of a propeller blade. Increasing or decreasing propeller size will have a direct bearing on the RPM's an engine will develop. This is due to the greater amount of propeller blade surface in contact with the water. See Figure E1.

B. Pitch

Pitch is a measure of helix angle, or angle of attack, of the rotating blade. Pitch is easily understood if one imagines the propeller rotating through a semisolid such as butter or jello. The distance the propeller will travel in one revolution is called "Pitch." Increasing or decreasing pitch will also have a direct bearing on engine RPM's because of the greater bite taken by the blade with each rotation. See Figure E1.

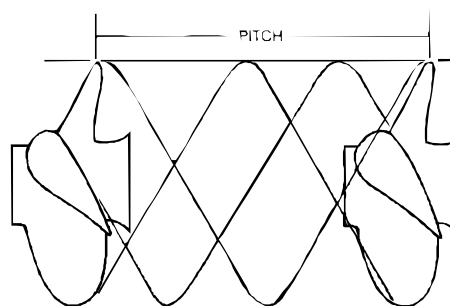
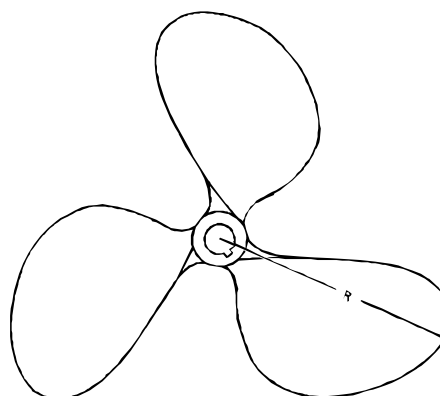

Figure E1: Propeller Pitch & Diameter

C. Prop Slip

When traveling through water a propeller is unable to get a complete bite because of the fluidity of water. "Prop Slip" is usually expressed as a percent of the computed theoretical speed. Fifteen to twenty-five percent prop slip is common for a sport-type boat operating at cruising speed.

Changing either diameter or pitch will have an effect on engine speed and prop slip, and in turn, directly affect the performance of a boat. The propeller(s) included with each Four Winns® boat provide the best general performance based on data obtained from on-the-water testing of that model. Variations in load, operating conditions, environment, the individual engine and hull performance may necessitate the purchase and use of another propeller(s).

Under your normal load conditions the engine(s) should turn within the maximum RPM range when at full throttle. If the engine(s) exceeds the recommended RPM, an increase in pitch and/or diameter is required. If the engine RPM is too low, a decrease in pitch and/or diameter is required.

An engine that is not developing full power and the load carried in a boat will directly affect performance of the engine. Always be sure the engine is properly tuned and load conditions are those normally experienced, before changing propellers.

For additional information on factors affecting performance, please consult your Four Winns® dealer.

E - 5 RUNNING ANGLE & POWER TRIM/TILT

Hull planing surfaces have the least amount of drag at a three to five degree angle with the water. This is the preferred running angle when boating. The running angle has a significant impact on top speed and handling. See Figure E2. Heavy load or certain water conditions may make it difficult to achieve the optimum running angle. The running angle can be controlled through the use of the power trim.

A. Power Trim

Trim angle is how far in or out, the drive or outboard motor is positioned in relation to the bottom of the boat. The trim angle of the drive or outboard engine has a distinct affect on the running angle of the boat.

The power trim system permits control of the trim angle of the drive or outboard motor relative to the boat, at the touch of a button. It allows the drive or outboard motor to be raised for shallow water operation. Power trim also allows the operator to adjust the motor while underway to provide the ideal running angle for a given load and water condition. Additional information can

be found in the engine operator's manual included in the owner's packet.

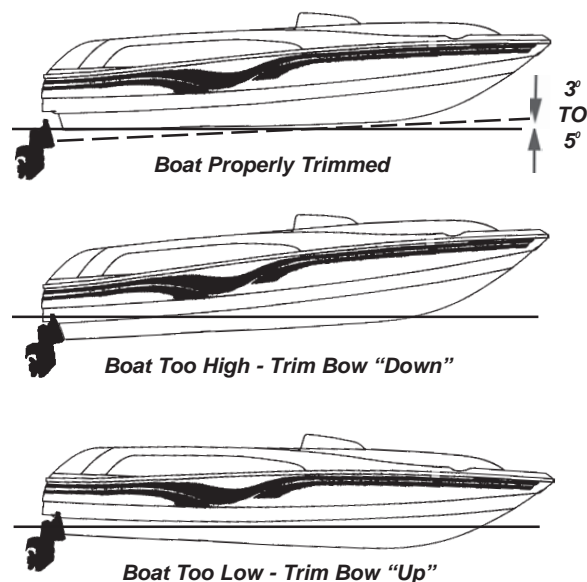

Figure E2: Running Angle

B. Power Tilt

Power tilt allows the operator to raise and lower the drive or outboard motor for trailering, launching, and beaching. Additional information on power tilt can be found in the engine operator's manual included in the owner's packet.

NOTICE

DO NOT operate the motor with the water intakes out of the water. Severe damage to the engine systems can result. Consult the engine operator's manual for specific information.

E - 6 ENGINE INSTRUMENTATION

The helm station on a 214 Candia FS (I/O or O/B) is equipped with a complete set of individual engine instrument gauges. These instrument gauges allow the boat operator to constantly monitor the operational condition of the engine. Close observation of these instrument gauges could save the engine from damage. See Figure E3.

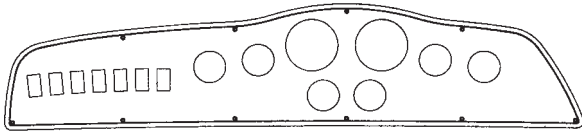

Figure E3: 214 Candia FS Dash Panel

Four Winns® is using a new style of instrumentation package on the 234/254 Candia FS which consists of a module similar to units used in the automobile industry. See Figure E4. Refer to Section E-6H for display functions.

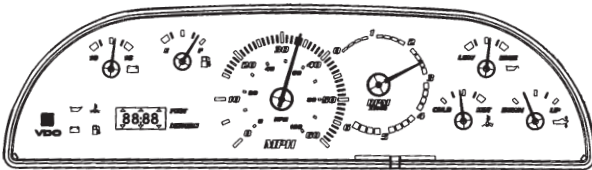

Figure E4: 234/254 Candia FS VDO Module

A. Tachometer

The tachometer indicates the speed of the engine in revolutions per minute (RPM). This speed is not the boat speed or necessarily the speed of the propeller. The tachometer may not register zero with the ignition key in the OFF position.

NOTICE

Never exceed the maximum recommended operating RPM of your engine. Maintaining maximum, or close to maximum RPM for extended periods can reduce the life of the engine.

Some engines are equipped with devices that limit engine RPM in accordance with the oil pressure, or engine temperature. Refer to the engine manual included in the owner's packet for additional information.

The tachometer must be set for different engines installed. This is typically done at the factory with the aid of a software program for the Four Winns®/VDO module.

The tachometer gauge for the 214 Candia FS I/O is shown below along with the table detailing the DP settings. See Figure E5 and DP Settings Table.

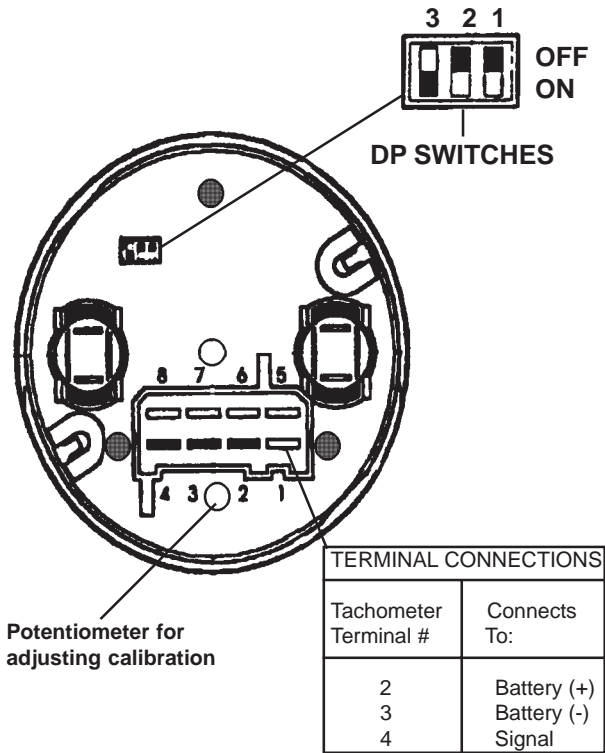

Figure E5: 214 Candia FS I/O Tachometer-Rear View

DP SWITCH SETTINGS (Gasoline Engines)		
DP Switch Number 1	ON	
DP Switch Number 2	DP Switch Number 3	Number of Cylinders
OFF	OFF	4
OFF	ON	6
ON	OFF	8

DP Switch Settings Table

214 Candia FS outboard model has an adjustment screw located on the back of the tachometer gauge. Turn the screw to the proper position. The proper position, either 2, 3, or 4, is determined by the number of cylinders the engine has.

B. Speedometer

The 214 Candia FS (I/O or O/B) speedometer is a water pressure sensitive unit. It has a pick-up (pitot tube) assembly mounted on the transom and a small plastic hose (speedo tube) that connects it to the speedometer

gauge on the dash. See Figure E6. The pitot tube extends below the hull. Water strikes the tube inlet and creates positive pressure. The faster the boat speed, the greater the pressure, and the higher the speed indication on the speedometer.

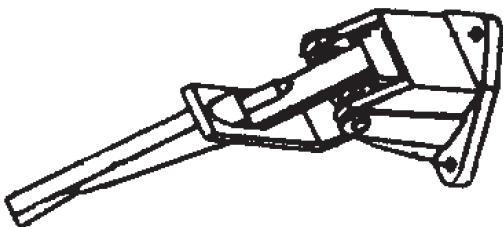

Figure E6: 214 Candia FS Speedo Sender

If the pick-up becomes clogged, the speedometer will not register. Clean the opening with a piece of wire or disconnect the tubing and blow out the pick-up with compressed air.

When winterizing the boat, the speedometer tubing must be drained of water. Disconnect the speedometer hose at the pick-up assembly and at the gauge and blow through the tubing to remove the water.

The electronic speedometer on the 234 and 254 Candia FS has a paddle wheel sender. This speedo sender provides accurate incremental readings (+/- 1.5 MPH) at low speeds as well as high speeds. The speedometer pick-up is located on the transom. See Figure E7. The paddle wheel extends below the hull.

As the boat is moving, water strikes the wheel making it spin. The information is relayed to the speedometer which displays the speed in miles per hour (MPH). The faster the boat speed, the faster the paddle wheel turns, and the higher the speed indication on the speedometer.

New for 2000 is that the paddle wheel is capable of determining the water temperature. It is equipped with a temperature sensor and relays this information to the module for display.

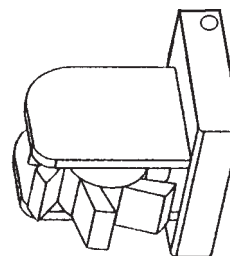

Figure E7: 234/254 CFS Paddle Wheel Speedo Sender

NOTICE

If the paddle wheel becomes fouled, the speedometer will not register. Clean the paddle wheel.

NOTICE

Speedometers are not precision instruments. The indications are relative and should never be used for navigational purposes or similar critical situations.

 **CAUTION**

DO NOT rely on the speedometer when trying to achieve a "NO WAKE" condition in a harbor or other enclosed waterway. ALWAYS reduce throttle! Speedometers are not effective at measuring low operational speeds. You are responsible for damage caused by the wake of your boat.

C. Temperature Gauge

The temperature gauge monitors the cooling system of the engine. A sudden increase in the temperature could be a signal of a blocked cooling passage or a water pump malfunction.

The temperature indicator on the 234/254 Candia FS module monitors the coolant temperature. If the coolant temperature rises to, or above 213 degrees F an alarm will sound a single beep every two seconds and the temperature telltale will illuminate.

NOTICE

Operation of an overheated engine can result in engine seizure. If an unusually high temperature reading occurs, shut the engine off immediately.

D. Oil Pressure Gauge

The oil pressure gauge indicates the pressure in the engine lubrication system. A drop in oil pressure is a possible indication of oil pump or leakage problems. If the oil pressure drops below 6 PSI (pounds per square inch), a single beep will sound every 2 seconds and the oil telltale will illuminate on the 234/254 Candia FS dash module.

NOTICE

Operation of an engine with abnormally low oil pressure can lead to engine damage and possible seizure. Have the engine serviced immediately upon a reduced oil pressure indication.

E. Voltmeter

The voltmeter monitors battery condition and thus alternator performance. See Section H for additional information regarding electrical systems.

On the 234/254 Candia FS cluster, the voltmeter indicates the voltage at the cluster. If the voltage is below 10 or above 16 VDC (volts of direct current) while the engine is running the telltale will light, and the cluster will beep every 2 seconds.

F. Fuel Gauge

The fuel gauge displays the level of fuel that is present in the fuel tank. The fuel gauge will operate when the ignition switch supplying power to the fuel gauge is in the RUN position. At 1/6 of a tank, a low fuel warning light will appear on the module.

Due to the mechanical nature of the fuel sender, variations in readings during various speeds of operation may occur. This system is merely a relative indication of the available fuel supply and not a calibrated instrument. Relative adjustments can be made by your Four Winns® dealer by bending the fuel sender float arm. Refer to Section I-1E Fuel Senders for additional information.

NOTICE

Use only clean fuel of the type and grade recommended by the engine manufacturer. The use of incorrect or contaminated fuel can cause engine malfunction and serious damage. Refer to Section I Fuel Systems for additional information.

G. Power Trim Gauge

Boats equipped with stern drives also have a “power trim gauge.” This gauge provides a visual indication of the inward-outward (trim angle) position of the outdrive. There is not a trailer travel mode on the gauge.

H. Depthsounder - 214 Candia FS I/O & O/B

The Depthsounder is standard equipment on your 214 Candia FS . It consists of two main components, the transducer and the HDR 600 unit. The transducer is mounted to the hull and the HDR 600 is installed in the dash. The transducer and HDR 600 communicate by means of a cable, and are powered by your boat’s 12-volt DC battery. The transducer and HDR use the basic principle of sonar to indicate the water’s depth. Please read the manufacturer’s literature included with the owner’s packet for information regarding operation and maintenance.

1. Control Functions

The HDR 600 uses a backlit 7-segment display in conjunction with a 3-button keypad to control all user functions. At initial power up, the unit will begin normal operation and display the digital depth and the units of measure. Figure E8 shows a typical view you might see on-screen at initial power-up.

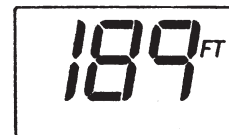

Figure E8: Depthsounder (HDR 600)

The HDR600 uses 3 buttons to control the Shallow Alarm, Deep Alarm, Keel Offset and Units of Measure function. While in normal operation, pressing the SET button selects a Function and blinks its corresponding indicator on the display. Once a Function has been selected it may be adjusted by pressing the UP and DOWN arrow buttons to adjust the setting. Further presses of the SET button will sequentially select the other functions for adjustment. All user settings are remembered by the HDR600, even when powered off.

When in the active function, a single press to an arrow button will result in a single incremental adjustment. Pressing and holding an arrow button will sequence through a range of adjustments. If no adjustment is made in 5 seconds, the unit will return to normal operation.

2. Shallow Alarm

The SHALLOW ALARM function can be set for depths ranging from 1 to 20 feet and sounds an alarm when the depth is less than the setting. See Figure E9.



Figure B9: Shallow Alarm

From normal operation, pressing SET once will display the SHALLOW ALARM setting and blink the "SHALLOW" icon. The UP ARROW will activate the SHALLOW ALARM and also increase the selected value. The DOWN ARROW will reduce the value. Hold the UP ARROW until you reach the desired depth setting. See Figure E10.



Figure E10: Shallow Alarm Setting Value

NOTICE

The maximum SHALLOW ALARM setting can not meet or exceed the current DEEP ALARM setting.

After your selection is made, the unit will return to normal operation after 5 seconds. The "SHALLOW" icon should now be visible. See Figure E11.



Figure E11: "SHALLOW" Icon

If the depth of the water is less than the selected value, the alarm will sound and the "SHALLOW" icon will blink to indicate the alarm. Pressing any button will mute the alarm; pressing SET will mute the alarm and activate the SHALLOW ALARM function for additional adjustment. To permanently turn off, use the DOWN ARROW to return the display to "OFF".

3. Deep Alarm

The DEEP ALARM can be set for depths up to 99 feet and sounds an alarm when the depth is greater than the setting.

Press SET until the DEEP ALARM function becomes active. This is indicated by the blinking "DEEP" icon. The UP ARROW will activate the DEEP ALARM and also increase the selected value. The DOWN ARROW will reduce the value. Continue to press and hold the UP ARROW until you reach your desired value. See Figure E12.



Figure E12: Deep Alarm Setting Value

NOTICE

The minimum DEEP ALARM setting can not meet or go below the current SHALLOW ALARM setting.

After your selection is made, the unit will return to normal operation after 5 seconds. The "DEEP" icon should now be visible. See Figure E13.



Figure E13: "DEEP" Icon

If the depth of the water is greater than the selected value, the alarm will sound and the icon will blink to indicate the alarm. Pressing any button will mute the alarm; pressing the SET will mute the alarm and activate the DEEP ALARM function for additional adjustment. To permanently turn off, use the DOWN ARROW to return the display to "OFF".

4. Units

The UNITS Control Function selects the UNITS of measure for depth readout and alarm functions. The three settings available are Feet, Meters or Fathoms. See Figure E14.



Figure E14: Units Control Function

Press SET until the units function is activated on-screen. This is indicated by the blinking UNITS icon. Pressing either arrow will allow you to select from the choices. Continue to press an arrow until the desired readout is selected: FT for feet, M for meters, FA for fathoms.

After your selection is made, the unit will return to normal operation after 5 seconds. The selected units icon should now be visible as shown in Figure E15.



Figure E15: Selected Units Icon

5. Keel Offset

The Keel Offset function adjusts the digital depth readout to display depth reading from either the waterline or the keel (lowest point) of the boat, instead of from the location of the transducer which is usually somewhere in between. This permits optimum transducer location and depth readouts suited to your needs.

To determine the value to enter into the KEEL OFFSET setting, first decide whether depth from the waterline or depth from the keel is desired. **Measurements will need to be made for the location desired.**

For depth from the keel of the boat, accurately measure the vertical distance between the face of the transducer and the keel of the boat. This measurement will then be entered into the Keel Offset function as a negative (-) number. See Figure E16.

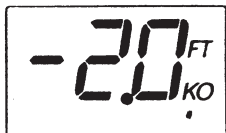

Figure E16: Negative Keel Offset

For depth measurements from the waterline, accurately measure the vertical distance from the face of the transducer and the waterline of the boat. This measurement will then be entered into the Keel Offset function as a positive (+) number. See Figure E17.

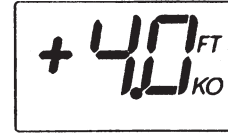

Figure E17: Positive Keel Offset

To Enable Keel Offset press SET until the KO icon is displayed on the screen. The default setting of the unit is off which is displayed as zero. From the default setting of 0.0, use the DOWN arrow to enter the negative (-) number to set the unit for depth from the keel. Or, from the default setting of 0.0, use the UP arrow to enter the positive (+) number to set the unit for depth from the waterline.

The available settings are +10 to -10 feet. After your selection is made, the unit will return to normal operation after 5 seconds. The "KO" icon should now be visible as shown in Figure E18.



Figure E18: Keel Offset Icon

Figure E19 depicts a scenario where the KEEL OFFSET has been set to -2 feet. The last drawing shows the return to normal operation with the updated depth readout.

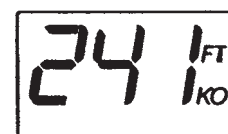
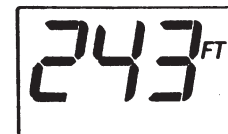

Figure E19: Keel Offset Scenario

NOTICE

DO NOT depend solely upon the depth sounder for water depth. It is important to have navigational charts of the waters in which you are operating.



WARNING

Do not rely on depth sounder to avoid submerged objects. Depth sounders provide a relative indication of water depth only.

6. Maintenance of HDR600 Depthsounder

If the unit comes into contact with salt spray, simply wipe the affected surfaces with a cloth dampened in fresh water. **DO NOT USE a chemical glass cleaner on the lens.** Chemicals in the solution may cause cracking in the lens of the unit.

When cleaning the LCD protective lens, use a cham-
 mois and nonabrasive, mild cleaner. Do not wipe while dirt or grease is on the lens. Be careful to avoid scratching the lens. Refer to the manufacturer's literature included in the owner's packet for additional information.

I. Clock and Depth Operation - 1999 VDO Module - 234 Candia FS and 254 Candia FS Models

The depthsounder is standard equipment on the 234 and 254 Candia FS models. Readings can be displayed in feet or meters on the VDO module. The depthsounder has both audible and visual alarm.

The transducer is factory installed and is water tested. It will be located in the bilge compartment to limit the effect of water turbulence while underway.

NOTICE

DO NOT depend solely upon the depthsounder for water depth. It is important to have navigational charts of the waters in which you are operating.



WARNING

Do not rely on depthsounder to avoid submerged objects. Depth sounders provide a relative indication of water depth only.

1. Four Winns®/VDO Clock and Depth Operation

The LCD display has two main functions, clock and depth functions. The operation and display of the functions is controlled by the SET and MODE push buttons. The programming of the FOUR WINNS®/VDO clock and depth operations of the instrument module is described in the following:

Changing from clock to depth is done by pressing both SET and MODE and holding them for 2 seconds. Pressing and holding both buttons again will toggle back to clock function.

When using single push buttons, you will need to hold the button in for 1/3rd of a second before the button will be accepted. This is to prevent accidental inputs while the boat is in motion.

2. Depth & Alarm

In depth mode, the display normally shows the current depth. If dashes are shown, the depth sounder is not generating valid data. If the current depth is less than the alarm depth, the up & down arrow heads will flash and the horn will chirp rapidly.

While in normal depth display, pressing the MODE button will cause the alarm depth to be displayed. After 10 seconds, the display will return to depth, or pressing MODE a second time will return to depth display.

If the alarm is on (chirping), when the alarm depth is displayed (using MODE) the audio part of the alarm will be disabled. Reentering the alarm display will re-enable the audio alarm. The flashing arrows will indicate an alarm condition whether the audio is on or off. If the audio alarm is disabled, it will be re-enabled automatically when the boat moves into water deeper than the alarm setting.

The alarm setting is always displayed as blinking digits, the current depth is displayed as steady (not blinking) digits. If the alarm screen is blank (set to zero), the alarm is not enabled. If the depth screen shows dashes the depth is zero or not found.

While in depth display, pressing the SET button will enter the alarm setting mode. The alarm setting will blink along with the down arrows on the display. Pressing MODE will set the alarm deeper in 1 foot (0.3 meters) steps. If the MODE button is held for 1 seconds the digits will scroll.

Pushing SET again causes the up arrows to blink, indicating shallower settings. Pushing the MODE button decreases the depth alarm setting.

Pushing SET a third time initiates "Units Mode". While in "Units Mode", the current "feet" or "meter" telltale flashes. Pushing the MODE button changes between feet and meters display and changes the flashing telltale.

Pushing SET a fourth time returns to "Depth Mode", or after 30 seconds of no activity on the buttons, the display returns to depth mode automatically.

NOTICE

If you have set your depth incorrectly and you are not sure how to reset your depth. You can disconnect the positive (red) terminal from the battery. After waiting a couple of seconds reconnect the positive terminal. This will clear everything and allow you to reprogram your shallow depth alarm and clock

3. Clock

The clock can display in 12 hour or 24 hour mode (military time). The time can be displayed in hours & minutes or in minutes & seconds. Pressing MODE while in clock mode (not setting) toggles the hr-min and min-sec mode. At an hour boundary the clock returns to hour & minute display.

To set the clock, press SET. The clock display will be in 24 hr. format (so that AM & PM are clear). Pressing MODE will increase the hours. Holding MODE for more than a second will cause the hours to scroll up.

Pressing SET again will cause the minutes to blink. The MODE button now acts on the minutes. Each time a new minute value is entered, the seconds are set to zero.

Pressing SET a third time allows you to set the 12/24 hour mode. The display will show 24:12 with the active mode blinking.

Pressing SET again returns to normal time keeping.

NOTICE

The clock has a three week auto shut-off capability. This will reduce the drain of your battery.

If your auto shut-off has occurred you will need to reset your alarm depth as well as your clock. Turn the ignition key to "ON" to power up the module and follow the preceding instructions regarding the depth and clock programming instructions.

If you have any questions or need assistance please contact VDO North America LLC at (540) 665-0100 or Four Winns® Customer Service at 231-775-1343.

J. Four Winns®/VDO Module Display Settings - 2000 234 Candia FS and 254 Candia FS

New for model year 2000, the LCD display has seven (7) basic functions, clock, depth, distance log, trip log, engine hours, trip hours, and water temperature. The operation and display of the functions is controlled by the MODE and SET push buttons. The programming of **all** the FOUR WINNS®/VDO displays is shown in the VDO "**Quick Start**" chart included at the end of this section. **Please note that the ADJUST button on the VDO Quick Start card is the SET button on the Four Winns® dash panel.** Also included in the following is a detailed description of the steps involved in setting the different display functions:

1. Clock

The Clock Display is selected by pressing the MODE button. Note that during Clock Display the colon blinks once per second.

The time of day is set by pressing and holding MODE and SET for 2 seconds while in Clock Display mode. The MODE button is then used to advance through the time set features. Hours are set first, then minutes, then 12/24 hour mode. The selected digits blink while being set. While in set mode the SET button is pressed to increment the selected unit. The hours is set in the 24 hour format, rolling to zero at 24. The minutes roll to zero at 60. While setting the 12/24 hour feature, 24 is displayed in the hours position and 12 is displayed in the minutes position. The current mode blinks (i.e. in 24 hour the "24" blinks).

MODE and SET are debounced for 3/8 of a second. If the SET button is held for 2 seconds while setting the numeric value the key auto repeats at a rate of 6 per second (i.e. to scroll through all 60 minutes requires 12 seconds). When the ignition is turned off the present mode is saved and the LCD displays the time of day. **The time setting functions are not available with the ignition off.** When the ignition is turned on the LCD returns to its prior display mode.

The clock keeps time up to 21 days after the ignition is turned off. During this time the system is in its power saving state. After 21 days the module shuts down to conserve battery power. When the ignition is turned on after 21 days, the clock restarts at midnight in the mode active at ignition off. The time of day must be set again.

NOTICE

The clock has a three week auto shut-off capability. This will reduce the drain of your battery.

2. Depthsounder & Alarm

The depthsounder is standard equipment on 235/254 Candia FS. Readings can be displayed in feet or meters. The depthsounder has both an audible and visual alarm.

The transducer is factory installed and is water tested. It will be located in the bilge compartment to limit the effect of water turbulence while underway.

NOTICE

DO NOT depend solely upon the depthsounder for water depth. It is important to have navigational charts of the waters in which you are operating.

 **WARNING**

Do not rely on depthsounder to avoid submerged objects. Depthsounders provide a relative indication of water depth only.

A shallow water depth alarm feature can be set in increments of 1' (0.3m). The operator sets the value by pressing and holding dashboard mounted MODE and SET buttons for 2 seconds. Entering shallow water causes a continuous chirping sound and blinking up/down arrow segments.

The shallow water alarm setting is displayed as blinking digits. Current depth is displayed as steady (not blinking) digits. **If the alarm screen is blank no shallow water alarm is set.** If the depth screen shows dashes the depth is zero or indicates a bad sensor reading.

Press the MODE button initiates "Set Mode". The shallow water setting blinks along with the down arrows on the display. Pressing the SET button sets the alarm towards deeper water. Pressing the MODE button again indicates the up arrows. With the up arrows on, press

ing the SET button sets the alarms towards shallower water. Holding the SET button longer than 1 second speeds up the process of making the alarm setting deeper or shallower.

Pressing the MODE button again allows the depth measurement units to be changed. While in "Units Mode", the shallow alarm setting blinks and the "FEET" or "METERS" telltale flashes. Pressing the SET button changes between feet and meters. Pressing the MODE button again allows the depth sounder system to be enabled or disabled. In this mode, a blinking message "ON" or "OFF" appears. Pressing the SET button changes between Sounder ON and Sounder Off. In the "OFF" mode the sounder no longer sends out its periodic sonar ping. **The "OFF" mode should be enabled when using Fish Finders or other equipment that has the same 200kHz frequency to avoid "Cross Talk".**

Pressing the MODE button again causes a return to normal "Depth Mode". In any case, thirty seconds after the last button press, the display automatically returns to depth mode. In Depth Display mode, pressing the SET button displays the shallow water alarm setting. The alarm setting blinks for ten seconds. When shallow water is encountered the up/down arrows blink and the audible alarm beeps.

Pressing the SET button turns the beeper off, but only for the present low water event. Entering deeper water re-enables the beeper for the next encounter with shallow water. See the VDO **"Quick Start"** card at the end of this section for additional directions.

3. Odometer (Log) and Trip Odometer (Trip Log)

The **Log** calculates total mileage based on input from the paddle wheel. **This value is unable to be reset except at the factory and is stored in nonvolatile memory.**

The **Trip Log** is a resettable distance that will display distance accumulated since the last reset. The operator presses both MODE and SET while in the Trip Log mode to reset to "Zero".

The Log and Trip Log functions will display Statute Miles when the Depth function displays "Feet". Kilometers will be displayed when the Depth displays "Meters". See VDO **"Quick Start"** card at the end of this section for additional directions.

4. Total (Engine) Hours

This function displays the total running hours (above 500 RPM) and will be displayed in 1 hour increments. This **value is unable to be reset**. See VDO **“Quick Start”** card at the end of this section for additional directions.

5. Trip Hours

This is a **resetable** function of the engine hours with Hour/Minute resolution up to 100 hours maximum. Pressing both the SET and MODE buttons while in Trip Hour mode resets the values to “Zero”. See VDO **“Quick Start”** card at the end of this section for additional directions.

6. Seawater Temperature

This function measures the water temperature at the paddle wheel speedo. When the Depth function is in “Feet” the function defaults to “°F” (Fahrenheit). When the Depth function is in “Meters” the temperature defaults to “°C” (Centigrade). See VDO **“Quick Start”** card at the end of this section for additional directions.

If you have any questions or need assistance please contact VDO North America LLC at (540) 665-0100 or Four Winns® Customer Service at 231-775-1343.

K. Ignition Switch

The ignition switch, for 2000 Funship models and newer, has four positions: OFF, RUN, ACCESSORIES, and START. The START position is spring loaded and the key should be held in this position until the engine starts. The key will return to the RUN position once released. Always turn the key to the OFF position when the engine is not running. This will prevent discharging of the battery(s). The ACCESSORIES position allows the operator to run the stereo without activating the other ship’s systems. Additional information on ignition switch operation is covered in Section A Operation, of this manual.

On 1999 Candia FS models and prior, the ignition switch has three positions: OFF, RUN, and START. The START position is spring loaded and the key should be held in this position until the engine starts. The key will return to the RUN position once released. Always turn the key to the OFF position when the engine is not running. This will prevent discharging of the battery(s).

L. Emergency Stop Switch

This safety device automatically stops the engine if the lanyard is attached to the operator and the operator falls from his work station. Refer to the engine manual for detailed information about using this switch.

The emergency stop switch (Figure E20) incorporates a shutoff switch, switch clip, lanyard, and lanyard clip. The lanyard clip must be securely attached to the operator’s PFD, clothing, arm, or leg. Be sure to attach the lanyard to a place where it is free of obstructions and to something that will move with the operator if he or she leaves the helm station. If the engine shuts down because this switch was activated, the clip may have to be reinstalled on the interrupter switch before the engine can be started.

 **WARNING**

Keep emergency stop switch lanyard free from obstructions that could interfere with its operation. Do not modify or remove emergency stop switch or bypass its safety features. The proper use of the emergency stop switch will prevent a runaway boat situation which can cause severe personal injury or death.

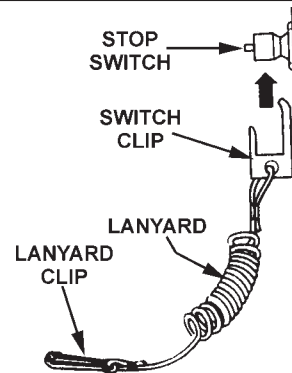



Figure E20: Emergency Stop Switch

The emergency stop switch can only be effective when in good working condition. Observe the following:

1. Lanyard must always be free of entanglements that could hinder its operation.
2. Once a month, check the switch for proper operation. With engine running, pull lanyard. If the engine does not stop, see your Four Winns® dealer.
3. Once a month, inspect both the clip and lanyard for cuts, breaks or wear. Replace worn or damaged parts.

In an emergency situation, any occupant of the boat can restart the engine. Just press in and hold the emergency stop switch button, then follow normal starting procedures. When the button is released, the engine will stop.

 **CAUTION**

Avoid knocking or pulling the clip or lanyard from the switch during regular boating operation. Occupants may be thrown forward or possible engine damage may occur by the sudden loss of engine power.

M. Engine Hour Meter

Engine hour meters are optional on most models and provide a numeric record of elapsed engine operating time. This information is important in determining scheduled maintenance intervals, ships log data, cruise information, etc. If so equipped, the hour meter will be located in the engine compartment.

The hour meter is connected to the ignition switch. Be sure the ignition switch is in the OFF position when the engine is not operating or the hour meter will record additional time.

N. Alarm Systems

The Four Winns®/VDO instrument module (standard on the 234 and 254 Candia FS models) has an audio and/or visual warning system for oil pressure, water temperature, low fuel, and voltage. It is actuated by various engine sensors.

O. Instrument Maintenance

Electrical protection for instruments and ignition circuitry is provided by fuses. The fuse block for the 234/254 is located inside the starboard storage compartment. In the case of the 214 CFS, the fuse block is located inside the starboard head, underneath the velcro fuse block cover. See Figure E21.

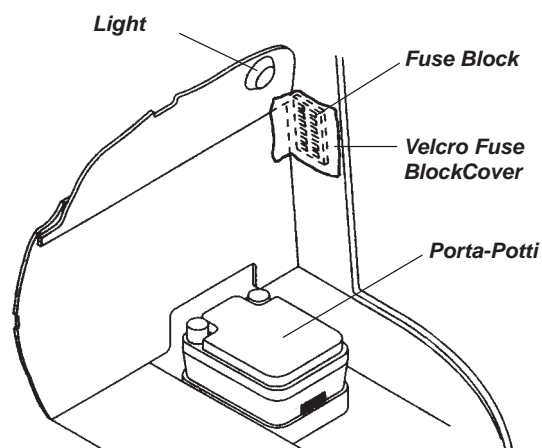

Figure E21: 214 CFS Head

Periodically, spray the ignition switch with a contact cleaner. The ignition switch and all instruments, controls, etc. should be protected from the weather when not in use. Four Winns® offers appropriate weather covers for each model. Excessive exposure can lead to gauge and ignition switch difficulties.

 **CAUTION**

DO NOT use a product such as WD-40 as a contact cleaner. Be sure to read the label before using any product.

Electronic gauges are affected by static electricity that builds-up on the glass face. Periodic washing of the gauge face with warm water and mild liquid detergent will help eliminate the static electricity problem and improve gauge accuracy.

P. VDO Quick Start Card

Please NOTE: The ADJUST button is the SET button on the Four Winns® dash panel.

VDO Marine Instrument Module
Quick Start for Display Settings
 Use the MODE button to Toggle through the 7 basic settings. Press both MODE and ADJUST to enter or change values. Arrow(s) show current function.

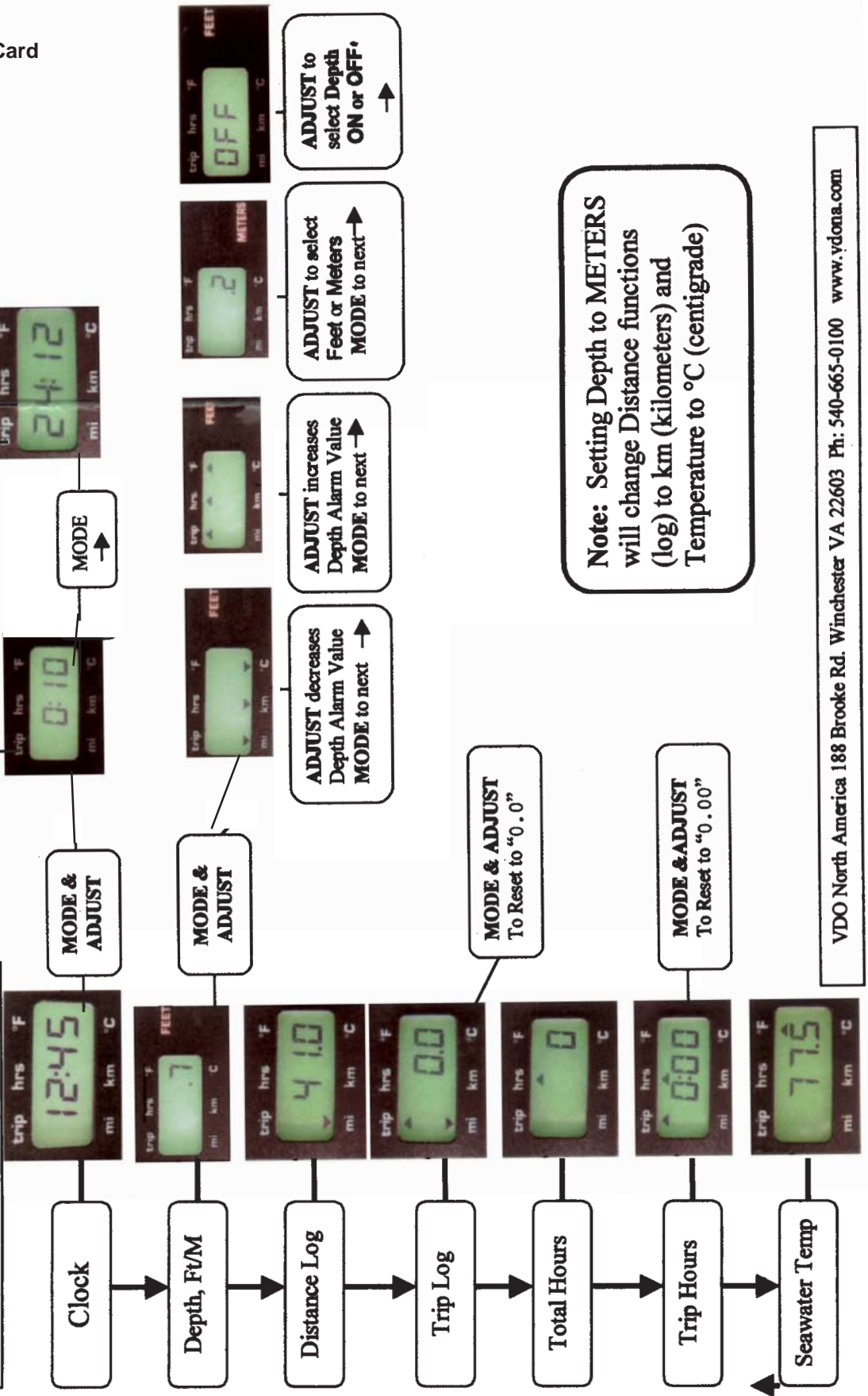

VDO North America 188 Brooke Rd. Winchester VA 22603 Ph: 540-665-0100 www.vdona.com

CONTROL SYSTEMS

F - 1 GENERAL

Control systems permit operation of the engine's throttle and shift mechanisms. They consist of three major components; the control, and the throttle and shift cables.

Your Four Winns® boat is equipped with a single lever concealed side mount control. This allows you to select forward or reverse gear, regulate engine speed, and ensure shifting is done at low engine speed.

A "start-in-neutral-only" feature which prevents starting in gear is included. Refer to F-3 Neutral Safety Switch in this section.

Also, the side mount control has a neutral lock button to prevent accidental shifting. It must be squeezed to permit shifting from neutral to forward or reverse.

Built into the control is a trim control which you can use to adjust the position of the out drive. Pressing the switch in the UP position moves the outdrive out and away from the transom. Pressing the switch in the DOWN position moves the outdrive in closer to the transom. The switch returns to its center neutral position when released. For additional information see Section E-5.

Neutral is in the center or straight up position. Rotating the control forward shifts the engine into forward. Rotating the control aft shifts the engine into reverse. Moving the lever further forward or aft increases engine speed.

NOTICE

When shifting, ensure engine speed is below 800 RPM to avoid damaging the shifting mechanism.

NOTICE

Allow the engine to warm up before engaging the shift control. Monitor all instruments while engine is idling during warm-up.

Specific information on controls and their operation can be found in the section on "Starting and Operation" in the engine manufacturer's manual included in the owner's packet.

F - 2 CONTROL OPERATION

A. Carbureted Engines

The shift mechanism on the controls can be disengaged to allow for easier starting and engine warm-up. See Figure F1. To disengage:

1. Place control handle in neutral position (B).
2. Press both neutral lock button (A) and shift disengage button (C).
3. Move control handle forward to increase throttle.

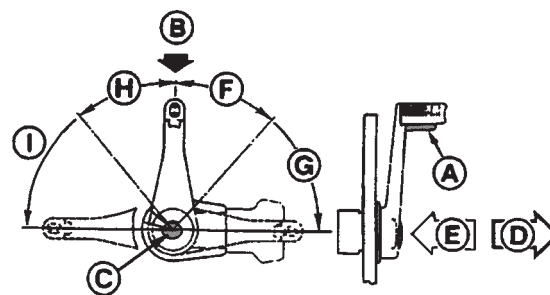

Figure F1: Control Operation

The neutral lock and shift mechanism will automatically engage when the control handle is returned to the neutral position.

4. Shift Mechanism Engaged (D).
5. Shift Mechanism Disengaged (E).
6. Reverse Shift Range (F).
7. Reverse Throttle Range (G).
8. Forward Shift Range (H).
9. Forward Throttle Range (I).

Refer to the engine manual, included in the owner's packet, for additional information on control operation.

B. Fuel Injected Engines (EFI)

On fuel injected engines, starting the engine is much easier and faster. It is not necessary to use the throttle while in neutral to cold-start the engine. Simply turn the key and allow the engine to warm up.

For additional information, refer to the section on "Starting and Operation" in the engine manufacturer's manual included in the owner's information packet.

F - 3 NEUTRAL SAFETY SWITCH

Control systems usually incorporate neutral safety switches within their design. This device prevents the engine from being started while the shift lever is in any position other than the neutral position. If the engine will not start, slight movement of the shift lever may be necessary to locate the neutral position and disengage the safety cut-out switch. Control or cable adjustments are required to correct this condition should it persist. See your Four Winns® dealer for necessary control and cable adjustments.

F - 4 CONTROL SYSTEM MAINTENANCE

Periodic inspections of the control, cables, and all connections should be made. Signs of looseness, rust, corrosion, wear, cable jacket cracks or other deterioration require immediate system servicing. Replace all damaged components.

Generally, periodic lubrication of all moving parts and connections with a light, waterproof grease is in order. Cables can be lubricated by positioning them to their fullest extension and applying light grease to the inner cable near the jacket. Working the cables back and forth will distribute the grease in the inner cable. Reapply the grease if necessary.

Lubrication should be performed as often as necessary to keep the system operating smoothly. Cable manufacturers such as Teleflex® and Morse® often offer special tools to make cable lubrication easier.

Cable and control adjustments may become necessary. Adjustment screws in the control, on the cables and in the linkage are provided.



DO NOT attempt control adjustments unless you are familiar with control systems service procedures. Control misadjustment can cause loss of control.

Other lubrication, adjustment and maintenance instructions are provided by the control manufacturer and are included in the owner's information packet.

STEERING SYSTEMS

G - 1 GENERAL

Four Winns® boats are equipped with rotary or hydraulic type steering systems. Tilt and power steering are features which are available on most models.

A. Rotary Steering

In the rotary system, a rotary drum assembly is mounted under the dash behind the steering wheel with a one piece cable running through the boat into the engine compartment. At the transom, the cable turns and is connected to the engine. Additional information on steering operation can be found in Section A-9.

B. Tilt Steering

The Candia FS (I/O only) models are equipped with tilt steering. To operate, depress the release lever (adjusting tab) with your thumb to tilt the steering wheel. Be sure to hold the top of the wheel to assist in positioning. Release the lever once the steering wheel is in the position desired. See Figure G1. Refer to the steering manufacturer's literature, included in the owner's packet, for additional information.

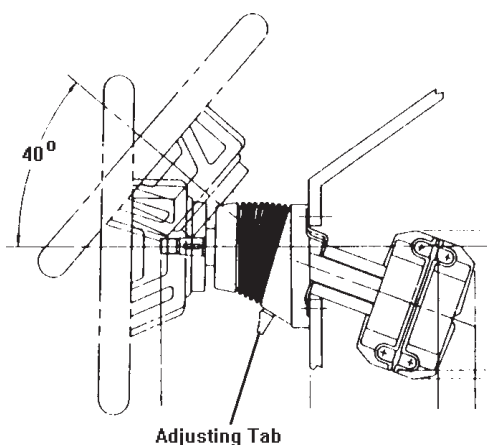

Figure G1: Tilt Steering Option

WARNING

The tilt mechanism should not be adjusted when the boat is moving. Sudden boat movement may cause loss of balance resulting in loss of control and/or injury.

WARNING

The tilt mechanism is spring loaded. Due to the variation in steering wheel offerings, the wheel may spring up rapidly when depressing the release lever. ALWAYS KEEP ONE HAND ON THE WHEEL DURING TILT ADJUSTMENT OR INJURY MAY OCCUR.

C. Power Steering

Power steering is also available. It is comprised of an engine mounted pump, hoses and steering cylinder. Power steering works in conjunction with the helm and steering cable to move the transom mount tiller arm and vertical drive more smoothly.

This is a "power assist" system and can greatly reduce steering effort required. It is not, however, a full power steering system as is used in automobiles. Some steering tension remains in the system.

On models with power steering, restricting movement of the steering cable will limit or stop the steering system's hydraulic assist.

NOTICE

DO NOT interfere with or restrict steering cable movement through the last 90° of bend at the engine. DO NOT use cable retainers, clamps or tie straps. Using one or all of these could restrict the cable movement near the engine. DO NOT tie wiring harnesses or other control cables to the steering cable. Make sure the deck coaming pads and bulkheads allow for steering cable movement in all positions of trim.

If the power steering becomes inoperative, steering will be harder and more effort will be needed to steer the boat. Check for a broken or loose belt on the power steering pump. Also, low fluid levels in the power steering pump reservoir will cause hard steering. If these items are not the source of the problem, check for equipment or other items lying on or up against the steering cable at the back of the boat. The cable must be free and clear to slide back and forth. Any item blocking free movement of the cable will result in harder steering and possible damage to the steering cable.

If the power steering system cannot be corrected on board, proceed at a reduced speed. The boat will be steerable, but with increased effort. Return the boat to your Four Winns® dealer as soon as possible to correct the power steering system.



CAUTION

If equipped with power steering, check the fluid level in the reservoir periodically. Low power steering fluid levels may increase steering difficulty.



CAUTION

After the first two hours of running time, check the entire steering system for loose bolts, nuts and fasteners which could adversely affect steering control.

NOTICE

When storing equipment in the engine compartment, be sure to avoid contact with the steering cable. Cables may become kinked or damaged and may increase steering effort.

Most Four Winns® boats equipped with stern drives are equipped with power steering. This is a “power assist” system and can greatly reduce steering effort required.

NOTICE

DO NOT force the steering unit to either extreme. This can place undue strain on the unit and can lead to hydraulic line or seal failure.

It is important that the power steering fluid be maintained to the proper level. If equipped with a power steering unit, please consult the engine manual for additional information. The engine manual is included in the owner’s packet.

For additional information, refer to the steering manufacturer’s literature included with this manual. Also, refer to the section on Steering in your engine manual.

D. Hydraulic Steering

The hydraulic steering system is comprised of the helm pump and reservoir, hydraulic hoses, and the hydraulic cylinder. The helm assembly acts as a pump to move the oil through the system. In many aspects this type of steering is similar to the mechanical system. Instead of activating a cable, turning of the helm causes fluid in the

hydraulic hoses to flow and activate the hydraulic cylinder causing the outboard to turn. See Figure G2.

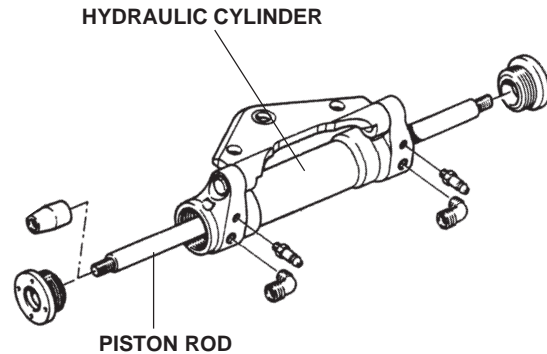

Figure G2: Hydraulic Steering

Upon commissioning the boat, it is necessary to purge the system of air. This is performed by your Four Winns® dealer during pre-delivery service. Should steering difficulty increase with time, it is possible additional bleeding of the system is required. See your Four Winns® dealer for assistance. This and other adjustments on power steering units are critical and should be performed only by a qualified service technician.

NOTICE

If equipped with the hydraulic system, a slight clicking sound may be heard as the wheel is turned. This sound is the opening and closing of valves in the helm unit; this is normal.

G - 2 PROPELLER TORQUE

The propeller rotation of a single engine installation will exert a directional force on the steering system. This can cause the steering to be harder in one direction than the other, and is called propeller torque. If this occurs, adjust the drive or outboard’s trim tab (when applicable). Refer to the engine manual, included in the owner’s packet, for information on adjusting the trim tab.

Propeller torque can also cause the boat to wander (not follow a straight line) when operated at low speeds. This condition is normal and can be corrected only by increasing engine rpm. Wind, water currents and play in steering components can cause equivalent effects.

CAUTION

Steering effort can vary significantly with engine acceleration, steering angle, trim angle, and sea condition. Be prepared for additional steering loads at all times.

G - 3 STEERING SYSTEM MAINTENANCE

A. General Maintenance

A periodic inspection of all steering cables, linkage and helm assemblies should be made. Signs of corrosion, cracking, loosening of fastenings, excessive wear, or deterioration should be immediately corrected. Failure to do so could lead to steering system failure and corresponding loss of control.

NOTICE

Check all bolts, nuts and fasteners for tightness.

B. Rotary System Maintenance

The helm and cable assembly should be so adjusted that the steering wheel is centered with the drive or out-board engine in the straight ahead position. There should be an equal number of turns to port and starboard from the straight ahead position. If adjustment becomes necessary, see your Four Winns® dealer.

Check all metal parts at the cable output end for corrosion. Remove any old grease from the cable ram and motor swivel connections using a mild solvent such as WD-40. Spray the cleaned areas with a moisture-displacing lubricant and apply a light coat of good quality marine grease. Do this with the ram fully extended. See Figure G3.

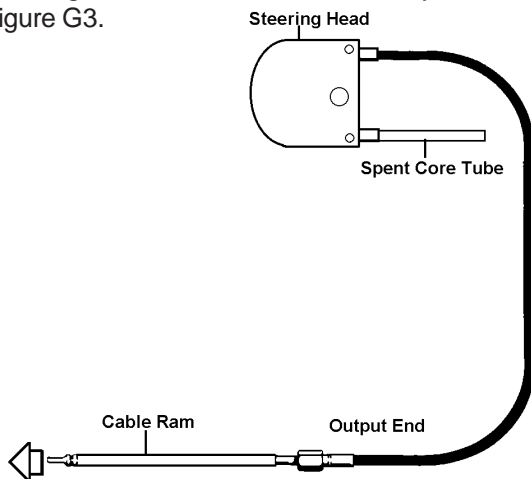

Figure G3: Steering Cable

C. Hydraulic System Maintenance

Hydraulic steering systems must periodically have all air purged from the system. Review the information provided by the hydraulic steering manufacturer for proper specifications and details on system service and maintenance.

D. Winter Storage

If the boat is placed in winter storage or used infrequently, clean the cable ram as instructed above. Cycle the steering several times when applying lubricant. If at any time the steering system becomes stiff, has an excessive amount of freeplay or shows any change in its operating characteristics, contact your Four Winns® dealer to have the system inspected.

ELECTRICAL SYSTEMS

H - 1 GENERAL

All electrical equipment on Four Winns® boats operate on 12 volt DC electrical power.

WARNING

Fire or Explosion Hazard!

Electrical system parts are designed by and manufactured to comply with the U.S. Coast Guard requirements to minimize risks of fire or explosion. **Never substitute automotive parts for marine parts.** Automotive parts do not provide the necessary ignition spark protection.

WARNING

To prevent equipment or electrical wiring damage, **DO NOT** tamper with any electrical connection, panel or harness, or attempt installation of any electrical equipment unless thoroughly familiar with the systems and are experienced in making such installations.

For detailed information on the electrical system, electrical schematics are located in the back of this manual.

H - 2 BATTERY SYSTEM

A. Single Battery System

A single battery is provided as standard equipment (12 volt DC) per Section H-1 above. The dash components are protected by a fuse panel. The location of this fuse panel is either in the starboard storage compartment of the 234/254 Candia FS models or in the head compartment of the 214 Candia FS model. On Outboard models, a separate in-line fuse is provided at the battery. Refer to Figure H1 and to the wiring schematics in the back of this manual.

When installing the battery, proceed as follows:

1. Connect the red (positive) cable running from the engine starter solenoid to the positive (+) battery terminal.
2. Connect the black (negative) battery cable running from the engine block to the negative (-) battery terminal.

CAUTION

When disconnecting the cables from the battery, make sure all switches are off and disconnect the black negative cable first to prevent spark.

NOTICE

DO NOT disconnect the battery while the engine is running. Alternator damage could result.

Monitor the battery's condition regularly with the Voltmeter in the dash panel. For additional information, refer to Section H-4 Electrical System Maintenance.

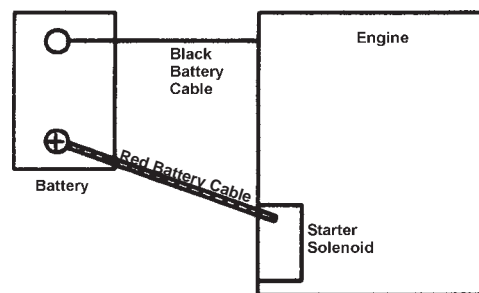

Figure H1: Single Engine-Single Battery Installation

H - 3 12 VOLT ELECTRICAL EQUIPMENT

A. Helm Equipment

The ignition, DC outlet, and panel switches are protected by a separate fuse panel located either in the head (214) or the starboard storage area (234/254). Descriptions of individual switches are describe in the following:

CAUTION

To avoid equipment damage or electrical fires, use only replacement fuses that are of equal rating to the original fuse. Refer to the electrical schematic included with this manual for proper sizes.

Horn - To sound the horn, push the HORN button.

Aft Bilge Pump - The PUMP switch at the dash is used to manually activate the bilge pump in the engine compartment. The bilge pump is used to remove water from the bilge (bottom of the hull) area of the boat by pumping that water overboard.

On all Candia FS models, the aft bilge pump is equipped with an automatic bilge switch and will operate whenever bilge water rises above the pump stop level. This will cause the internal float to move upward and activate the pump.

When leaving your boat unattended for an extended period, check the charge on the battery(s) periodically. Also check the water level in the bilge and make sure the float switch is functional.

If the automatic bilge pump must be disabled, disconnect the wiring plug near the bilge pump.

Bilge Blower- The BLOWER switch is used to activate the bilge blower. The bilge blower is used to remove any gas vapors that may have accumulated in the bilge or engine areas.



WARNING

Gasoline vapors can explode resulting in injury or death.

1. Before starting the engine, check the engine compartment bilge for gasoline or vapors.
2. Operate blower for four (4) minutes, and verify blower operation. Run blower when vessel is operating below cruising speed.

To verify blower is operating place your hand over the vents. DO NOT rely on the sound of the blower. Be sure a substantial amount of air is being exhausted by the bilge blower. Check the bilge blower system often, preferably before each cruise.

Navigation & Anchor Lights - Moving the NAV/ANC LTS switch towards the NAV position activates the bow lights and the all-around light or both portions of the mast light. Move the switch to the ANC position to activate the all-around light or both the fore and aft portion of the mast light. The center switch position is OFF.

Wipers - The WIPER switch activates the windshield wiper. This is an option for the starboard side only.

Accessories - Additional 12 volt equipment may be added to the boat using the accessory switch. Certain accessories may be wired directly to the fuse block below the dash. For more information, refer to Section H-3B Installation of Additional 12 Volt Equipment.

Cockpit Lights - The CKPT LTS switch is used to activate the cockpit (courtesy) lights.

B. Installation of Additional 12 Volt Equipment

On the fuse panel, non-factory installed 12 volt accessory equipment can be connected to the "ACC" terminal. Accessory equipment can also be wired directly to the "ACC" switch on the dash.



CAUTION

Be sure to provide proper fuse protection for all 12 volt equipment that is installed. Accessory current should be limited to 20 amp if the connection is made to the fuse block. If the "ACC" switch is used, the current should be limited to 15 amp. Gauge and 12 volt equipment may operate improperly and cause possible internal damage at higher levels.

C. Interior Equipment

Stereo - On all models, the stereo is mounted at the dash. It is connected at the fuse block and has a separate in-line fuse provided in the stereo wiring for protection. For stereo operation, please refer to the manufacturer's manual included in the owner's information packet.

NOTICE

Please note that when the ignition switch is placed in the off position the stereo is also shut off. This applies to 2000 models and newer only. On prior 2000 model boats, follow the directions indicated in your stereo manufacturer's operating instructions.

H - 4 ELECTRICAL SYSTEM MAINTENANCE

A. Battery Maintenance

Be sure to keep the batteries charged. Also, keep the batteries clean, especially the terminals and connection

lugs. The battery cables must be fastened securely while in use.

Check the battery fluid level often, especially when a charger/converter is being used. Recharge a battery indicating a low voltage. Determine the reason for the discharge. Alternating battery usage with dual batteries is important. Refer to the Electrical System section in the engine manufacturer's manual for additional information on care and maintenance of batteries.

 **DANGER**

Batteries produce hydrogen and oxygen gases when being charged. These explosive gases escape through the vent/fill caps and may form an explosive atmosphere around the battery if the ventilation is poor. This gas may remain around the battery for several hours after charging. Sparks or flames can ignite the gas and cause an explosion.

 **WARNING**

Fire or Explosion Hazard!

Only qualified personnel should install batteries and perform electrical system maintenance. Do not expose batteries to open flame or sparks. Do not smoke near batteries.

 **WARNING**

Poison!

Sulfuric acid in batteries can cause severe burns. Avoid contact with skin, eyes, or clothing. Wear goggles, rubber gloves and protective apron when working with batteries. In case of skin contact, flush with water at least 15 minutes. If swallowed, drink large quantities of water or milk. Follow with Milk of Magnesia, beaten egg or vegetable oil. Get medical attention immediately.

 **WARNING**

Disconnect the battery before working on electrical or ignition system to prevent electrical shock and accidental ignition.

B. Electrical Wiring Maintenance

Periodically, inspect all wiring for nicks, chaffing, embrittlement, improper support, etc. Spraying the electrical connections with an electrical connection cleaner will reduce corrosion and improve electrical continuity.

 **CAUTION**

DO NOT allow corrosion to build up on connections. This can cause equipment to operate improperly.

The American Boat and Yacht Council (ABYC) has published a standard for the color coding of boat wiring. Four Winns® voluntarily complies with these standards so the owner of the new boat can easily install new equipment or troubleshoot the electrical system. The following table summarizes the color code system:

Wire Color	Wire Designation
Red	Wires on positive (+) side of battery that go to starter. This wire is non-protected.
Red/Purple Stripe	50 amp protected wire that runs from the engine to the fuse panel at the helm.
Yellow with Red Stripe	Wire from starter switch to starter solenoid.
Yellow	Power lead to bilge blower from a fuse or switch.
Dark Gray	Sensor wire from tachometer sender to tachometer.
Brown/Red	Leads to bilge pump from switch.
Brown/Orange	Leads to auto bilge pump.
Purple	Wire between ignition switch and coil. Wire from ignition switch through distribution panel to electrical instruments.
Orange	Accessories
Dark Blue	Wire from switch to instrument lights.
Light Blue	Sensor wire from engine oil pressure sender to oil pressure gauge.
Tan	Sensor wire from water temperature sender to water temperature gauge.
Pink	Sensor wire from fuel tank level sender to fuel gauge.
Purple/White	Trim position
White/Green	Trim down
White/Blue	Trim up
White/Red	Trim power
Black	Ground
Gray/Green	Bow light
Gray/Blue	Stern light

Note: Some of these colors can serve more than one type of circuit.
Wiring Color Code

H - 5 STRAY CURRENT CORROSION

A. General

Electrically induced underwater corrosion occasionally affects boats and their related components. This is referred to as “Stray Current Corrosion” and appears as surface pitting or deterioration. Stray current corrosion is the decomposition of chemical compounds by electric current.

Stray current corrosion can be caused by the polarity of the dockside wiring system of the boat being reversed from the power source (reversed polarity) or surrounding boats, an improperly wired battery installation, other boats that are in close proximity that have electrical power leakages, or any other source close to the boat that has electrical power leakage into the water. Stern drive units are especially vulnerable to stray current corrosion.

Periodically inspect the drive components and thru-hull fittings to determine if stray current corrosion damage exists. If corrosion damage is found, determine and correct the cause of stray current to prevent further damage. Consult an experienced marine electrician or contact your Four Winns® dealer for assistance.

The use of some shore power battery chargers, while the boat is in the water and the battery is connected to the system, can cause stray current corrosion. Have an experienced marine electrician review any battery charger installation to ensure a stray current corrosion problem will not develop. An improper battery connection is a common cause of stray current corrosion.

NOTICE

Use only “Coast Guard” approved battery chargers. Consult your Four Winns® dealer for his recommendations.

Corrosion is usually more prevalent in polluted or salt water than in clean water. It is also more likely to occur when dockage is in an area with steel piers, large metal boats, or where shore power is in use.

B. Galvanic Corrosion

Galvanic corrosion results from a potential electrical difference existing between dissimilar metals immersed in a conductive solution (e.g., salt water). If these metals touch or are otherwise electrically connected, this potential difference produces an electron flow between them. The attack on the more active metal is usually

increased and the attack on the less active metal is decreased, as compared to when these metals are not touching.

C. Corrosion Prevention

Anti-corrosion anodes are attached to the bottom of the gimbal housing to prevent corrosion to your stern drive and underwater parts. These anodes will be slowly eroded away by galvanic action and require periodic inspection. Please refer to the section on “Anti-Corrosion Anodes” in your engine manufacturer’s manual for additional information. The engine manual is included in the owner’s packet.

FUEL SYSTEMS

I - 1 GASOLINE FUEL SYSTEMS

Gasoline fuel systems used in Four Winns® boats are designed to meet or exceed the requirements of the U.S. Coast Guard, the National Marine Manufacturers Association, and the American Boat and Yacht Council in effect at the time of manufacture.

Tanks on Four Winns® boats are located forward of the aft bilge compartment below the floor. Below is a list of fuel tank capacities by model.

Fuel Tank Capacities

MODELS	CAPACITY
214 Candia FS*	50 GAL.
234 Candia FS	73 GAL.
254 Candia FS	73 GAL.
*V/O & O/B Models	

NOTICE

Use only clean fuel of the type and grade recommended by the engine manufacturer. Engine damage resulting from the use of a lower octane gasoline is considered misuse of the engine and will void the engine warranty. Refer to the section on Gasoline Requirements in the engine manual for information on octane specifications.

A. System Testing

All gasoline fuel systems have been factory inspected and pressure tested in accordance with regulations in effect at the time of manufacture. Additionally, each fuel tank must pass rigid tests and inspections performed by the fuel tank manufacturer.

Prior to taking delivery, it is important that a full inspection be made of the entire fuel system by the selling dealer. An entry on the Four Winns® Pre-Delivery Inspection Form portion of the Warranty Registration Card will attest to the dealer's performance of this service.

B. Fuel Fills

Fuel fill deck plates are located either on the aft deck or side decks, and are marked "GAS". To open, push the tab in and lift up on the cap. Be sure to utilize the proper type and grade of fuel. See Section I-3 for additional information.

The fuel fill fitting allows for venting below the fill cap. While the tank is being filled, the air displaced by the fuel escapes through the fuel fill/vent. This reduces the amount of fuel spillage. **Always** open the lid slowly to allow air to escape. See Figure I1.

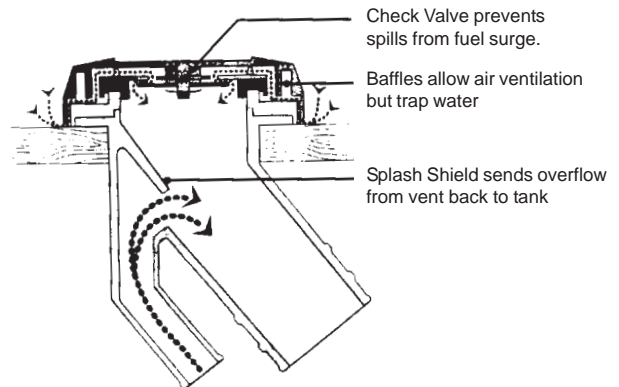

Figure I1: Fuel Fill

The gasket seal on the fuel fill cap assists in sealing when closed. A missing or damaged gasket can allow water on the surrounding surfaces to run into the tank. Periodically inspect the gasket and the fuel deck plate for damage.

WARNING

DO NOT confuse GAS deck fill plate with WATER or WASTE deck plates. Deck fill plates are labeled according to the intended use.

WARNING

Spilled fuel is a fire hazard. DO NOT overfill or overflow the tank, or allow fuel spills into the hull or bilge. If spillage occurs, clean up immediately and dispose of soiled rags/towels in a proper container.

NOTICE

When fueling at a marina, DO NOT overfill. Fuel may spill into the water.

After fueling, replace the fill cap, and wash the areas around the fuel fill plate. Residual fuel left on the deck and hull sides can be dangerous, and will yellow the fiberglass. It will also damage the tape stripes and logos.

C. Anti-Syphon Valves

The fuel withdrawal line is equipped with an anti-syphon valve where the line attaches to the fuel tank. This valve prevents gasoline from syphoning out of the fuel tank should a line rupture. See Figure I2 for anti-syphon location.

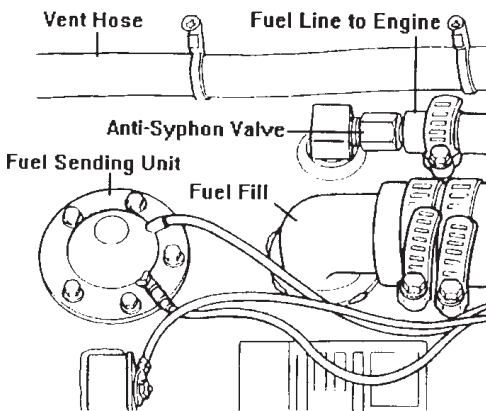

Figure I2: Fuel Tank Fittings

CAUTION

The fuel withdrawals are positioned in the fuel tanks to achieve optimum fuel usage, and fuel line routing. At certain speeds and hull trim angles, the fuel supply at the withdrawal tank location can increase or decrease accordingly. Be extremely careful when attempting to operate the boat on a minimum amount of fuel. Though some fuel may be in the tank, the relative trim angle of the boat may cause the fuel to flow away from the withdrawal.

NOTICE

Access plates or lids are provided in the floor for easier access to the fuel pick-up, anti-syphon valve and sender.

D. Fuel Gauge

The fuel gauge indicates the amount of fuel in the tank. See Section E-6F Fuel Gauge for additional information on fuel gauge use.

E. Fuel Senders

The fuel sender consists of a mechanical arm with float which measures the fuel in the tank. The sender arm adjusts with the amount of fuel in the tank and sends a signal to the fuel gauge. See Figure I3.

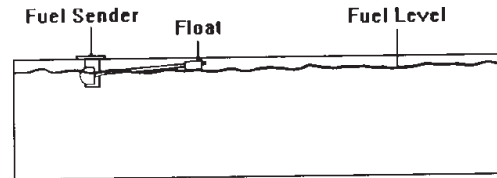

Figure I3: Fuel Sender Operation

Due to the mechanical nature of the fuel sender, variations in readings during various speeds of operation may occur. This system is merely a relative indication of the available fuel supply and not a calibrated instrument. Relative adjustments can be made by your Four Winns® dealer by bending the fuel sender float arm.

The gauge readings will also vary with the trim angle of the boat. When sitting at a dock and the boat is nearly level, the fuel gauge will register accurately. Refer to Figure I3. When boating, the trim angle of the boat changes and affects the gauge readings. Under these conditions, the fuel sender will register "full" for the first few hours of running time until the fuel level drops below the 3/4 or 1/2 mark. This is caused by the angle of the fuel in the tank as shown in Figure I4.

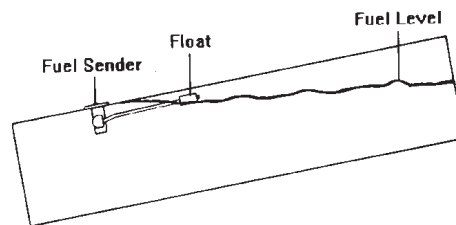

Figure I4: Effects of Trim Angle

It is very important to keep track of hours and fuel consumption to obtain an average gallon per hour consumption figure. Refer to the fuel log located at the back of this manual. This will prevent any problems with running out of fuel on the water.

Dealers are equipped with some general figures on consumption which can be used as a guide until specific information on your boat is determined. Because of boating conditions, speed, weight and other factors common to your situation, fuel consumption will vary between your boat and consumption figures developed by Four Winns®.

When the fuel gauge begins to register below the “full” mark, the gauge readings will drop much faster until it reads “empty”. When this occurs, the trim angle has affected the sender reading. When the gauge registers “empty”, the sender has bottomed out and there may be 3 to 4 gallons of fuel in the tank. See Figure I5.

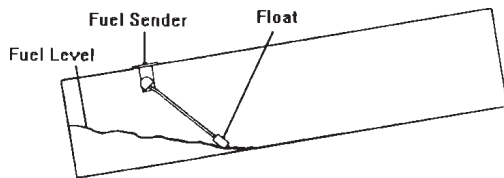

Figure I5: Trim Angle Effect with Low Fuel

F. Fuel Filters

Fuel filters are installed on each engine. Filters should be cleaned or changed frequently to assure an adequate supply of fuel to the engine. Refer to the engine manual for additional information. The engine manual is included in the owner’s information packet.

NOTICE

Canister-type filters should be changed annually.

G. Use and Maintenance

WARNING

DO NOT let the odor of gasoline go unchecked. If the odor of gasoline is noted, DO NOT START ENGINE. If engine is running, SHUT OFF ENGINE, ELECTRICAL AND HEAT GENERATING EQUIPMENT. Investigate and correct the situation immediately! Have all passengers put on personal flotation devices and keep fire extinguishers at hand until the situation is resolved.

WARNING

Avoid serious injury or death from fire or explosion resulting from leaking fuel. Inspect systems for leaks at least once a year.

WARNING

To help guard against damage, avoid the storage or handling of gear near the fuel lines, fittings and tanks.

The warning label below is placed in areas that are large enough to accommodate a six gallon portable fuel tank.

WARNING

No ventilation is provided. Fuel vapors are a fire and explosion hazard. To avoid injury or death **do not store** fuel or flammable liquids here.

I - 2 FUEL STANDARDS

Be cautious when using gasoline that contains alcohol. Refer to the section on gasoline requirements in your engine manual for additional information.

CAUTION

To conform to Federal Air Quality Standards, the petroleum industry reduced the amount of tetraethyl lead in gasoline. Alcohol is being blended with gasoline to help restore the octane rating lost when the lead was removed. While blending alcohol with gasoline increases the octane level of the fuel, it can also create certain safety and performance related problems for boaters.

A. Problems With Alcohol In Gasoline

Below is a list of problems which may be experienced when using blended gasoline.

1. Premature deterioration of fuel system components may occur. Alcohol will attack rubber fuel hoses, fuel tanks, fuel filters, fuel pumps and rubber gaskets. This deterioration will lead to fuel system leakage.

2. Phase separation of fuel will cause contamination. Water which accumulates in the tank through contamination or condensation will be absorbed by the alcohol. This water-heavy alcohol will settle at the bottom of the tank. This phase separation will lead to fuel tank corrosion. This may also result in a lean mixture to the carburetor and cause engine stalling or possible engine damage.

The use of alcohol additives in gasoline has become more widespread. Regulations on public notification of the existence of additives is currently controlled by the Environmental Protection Agency (EPA). Some states do require that gasoline pumps display information on additives (especially alcohol). If alcohol content is not posted, ask and avoid using fuel containing alcohol if possible.

B. Recommendations

Assume blended gasoline is being used and follow these recommendations below.

1. Inspect fuel hoses often. A deteriorated hose containing alcohol blended gasoline will normally be soft and swollen. A deteriorating hose containing no fuel will normally be hard and brittle. In both cases the hose should be replaced.
2. Ventilate the engine compartment before starting the engine(s). Operate the engine compartment blower for four (4) minutes. Then, prior to starting the engine(s), check the bilge area for the scent of gasoline fumes; DO NOT start the engine(s) if the odor of gasoline is detected.
3. Frequently inspect the fuel system fittings. Inspect the fuel tank, pump and filter for signs of leaks or corrosion. Visually inspect for deteriorating metal fittings at the fuel hose connections.



WARNING

Avoid serious injury or death from fire or explosion resulting from leaking fuel. Inspect system for leaks at least once a year.

If areas are found within the fuel system that appear questionable, have a qualified marine technician inspect the system. A thorough fuel system examination should be made by an experienced marine technician at least once a year.

I - 3 FUELING INSTRUCTIONS

1. Avoid fueling at night except in emergencies.
2. When moored at fueling pier:
 - a. Do not smoke, strike matches, or throw switches.
 - b. Stop all engines, motors, fans, and devices that could produce sparks.
 - c. Put out all lights.
3. Before starting to fuel:
 - a. Ensure that boat is moored securely.
 - b. Be sure the proper type and grade of fuel as recommended by your Engine Owners Manual is used.
 - c. Determine how much additional fuel is required to avoid overflow.
4. During fueling:

Keep the fill nozzle in contact with the fuel opening at all times to guard against possible static spark. See Figure I6.



WARNING

Spilled fuel is a fire or explosion hazard. DO NOT overflow the tank or allow fuel spills into the hull or bilges. Avoid overboard spills. Visually monitor the fuel vent located on either the transom or side of the hull. When the tank is full, fuel will flow from the fuel vent.

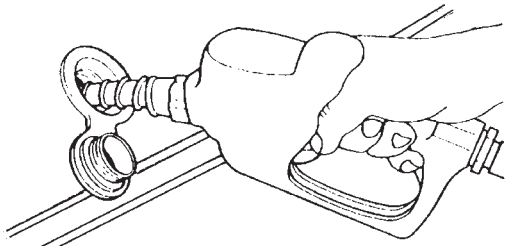

Grounding the fuel hose - Proper

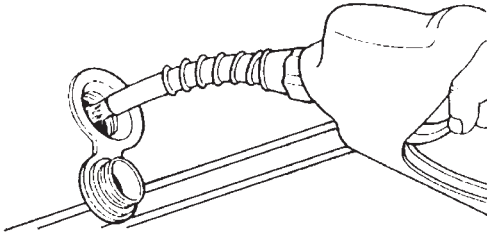

Not grounding the fuel hose - Improper

Figure 16: Grounding Fuel Hose

5. After fueling:
 - a. Replace all fill caps securely.
 - b. Wipe up any spilled fuel.
 - c. Determine that there is no odor of gasoline in the engine compartment or below decks before starting machinery, turning on lights or lighting stove. Operate the bilge blower system for at least four (4) minutes before engine start-up.
 - d. Be prepared to cast off moorings as soon as engine is started.

WASTE AND WATER SYSTEMS

J - 1 GENERAL

Some Four Winns® models are equipped with a fresh water supply system. This system consists of a water supply tank, water distribution lines and a distribution pump. Refer to Figure J5 at the end of this section for general water system diagram. The water fill deck plate for the fresh water system is located on the deck. Always fill the tank slowly.

The approximate location of the water fill for each model is listed below.

Water Fill Locations

MODELS	DECK WATER FILL LOCATION
214 Candia FS*	Port side of deck , even with the port console.
234 Candia FS	Port side , At the stern, on top of step.
254 Candia FS	Port side , At the stern, on top of step.
*I/O & O/B Models	



CAUTION

The water deck plate is appropriately labeled. DO NOT fill the system with anything other than water. Should the system become contaminated with fuel or other toxic solution, component replacement may be necessary.

The water tank is equipped with an overboard vent. Maintain a close visual watch on the overboard vent while filling the water tank. Always fill the tank slowly. When the tank is almost full, water will spurt out of the vent.

NOTICE

When filling the tank, never seal the hose to the deck plate. The tank would become pressurized and could rupture.

The following is the capacity and location of water supply tanks.

NOTICE

DO NOT overfill the water tank. Tank damage may result. Water capacity and tank location may vary due to other equipment that may be installed on the boat.

Water Tank Capacities

MODELS	TANK CAPACITY	LOCATION
214 Candia FS*	7 gal./26.5 l	Port side , underneath the cockpit sink.
234 Candia FS	7 gal./26.5 l	Port side , At the stern.
254 Candia FS	7 gal./26.5 l	Port side , At the stern.
*I/O & O/B Models		

The materials from which the components of the water system are made may give the water supply a peculiar taste, especially when new. This condition is normal and can be reduced somewhat through the use of a water filter; such as that produced by Ametek®, Inc. Also, chemicals such as Sudbury's Aqua-Fresh™ and Pettibone's Aquabon™ are effective. The taste will completely dissipate in time.

J - 2 DISINFECTING THE WATER SYSTEM



WARNING

The fresh (potable) water system should be disinfected prior to initial use.

The water system should be disinfected before first use and at the beginning of each season. The following information is a general guide to disinfecting the fresh water system.

1. Flush the boat's water system thoroughly with fresh water. Make sure all antifreeze is removed from the system.
2. The water system should be drained completely.

3. To disinfect the water system, use one gallon of water and 1/4 cup of Clorox or Purex household bleach (5% sodium hypochlorite solution). This is recommended for each 15 gallons of tank capacity.
4. Allow to stand for three (3) hours. If time is a factor, greater concentrations of chlorine solution will be needed to disinfect the water system.
5. Drain the system.
6. Flush the system thoroughly with fresh water.
7. Fill the system with fresh water.

To remove excessive chlorine taste or odor which might remain in the system, prepare a solution of one quart vinegar to five gallons water and allow this solution to agitate in the tank for several days during boating. Then drain tank and refill with fresh water.

The cockpit sinks are equipped with traps, and the water will drain slowly. If the system is not operating properly, have it checked by your authorized Four Winns® dealer.

J - 3 FRESH WATER SYSTEMS

A. Cockpit Sink - Head Sink

The cockpit sink with tap is standard on the 214 Candia FS model. It is integrated into the port console. The water pump and water tank for the cockpit sink is located underneath the cockpit sink console and will draw water when the switch is operated. See Figure J1. The switch is located next to the faucet. After the tank has been filled, operate the pump switch until water comes out of the faucet.

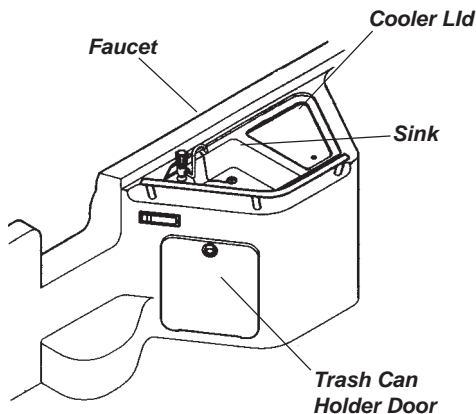

Figure J1: 214 Candia Port Console w/Sink & Cooler

The 234 and 254 Candia FS models have a sink placed in the enclosed head. The water pump and tank for the cockpit sink is located on the port side near the stern and will draw water when the switch is operated. See Figure J3. The switch is located on the head sink console and is marked FRESH WATER. After the tank has been filled, operate the pump switch until water comes out of the faucet. After all the air has been purged from the system and a steady flow of water is coming from the faucet, turn off the pump.

NOTICE

If the line is routed improperly, kinked or is dislocated, the water pump may not operate properly. Inspect and correct the hose routing (if necessary). If a problem still exists, contact your Four Winns® dealer for assistance.

NOTICE

DO NOT operate the pump with an empty tank. Damage to the water pump may result. Be sure the pump switch is off when not in use.

B. Cockpit Entertainment Center - 254 Candia FS

The 254 Candia FS comes equipped with an entertainment center located on the starboard side, behind the helm seat. The entertainment center includes a removable cooler, trash receptacle, covered sink, and additional storage. The switch to operate the faucet is located on the instrument dash and is marked ACC. The same fresh water pump is utilized by both the head sink, covered sink, and transom washdown option.

C. Transom Washdown

The transom washdown option is available on all Candia FS models. The washdown unit is located on the starboard side of the transom. The water supply system can be used for showering or washdown purposes at the transom. The switch to operate the washdown is located on the instrument dash and is marked ACC. See Figures J2 & J3.

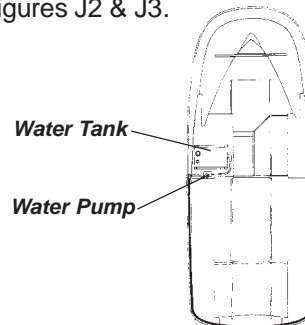

Figure J2: 214 Candia FS WaterTank Location

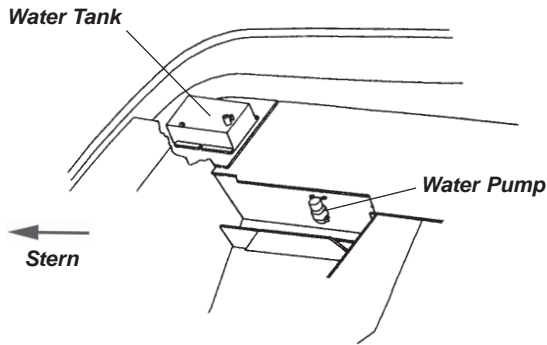

Figure J3: 234/254 Candia FS WaterTank Location

The fresh water tank has a seven gallon capacity and is located in the rear engine compartment on the port side of the 234/254 Candia models. The water fill deck plate, for the 234/254, is located on the port side, near the stern of the boat, on the top of the step. The 214 Candia's water tank is located underneath the cockpit sink and the water fill is on the port side of the deck, even with the port console. The fresh water deck fills are clearly mark "WATER". See Figures J2 & J3.

A separate toggle switch to operate the pump is located at the transom and is wired directly to the battery. An in-line fuse is included to protect the water pump. The pump is located in the rear engine compartment on the port side for most models.

Models equipped with the transom washdown option will use the same fresh water pump used for the cockpit sink. With the pump switch "ON", push the spray nozzle button to purge any air that may be in the system. When a steady flow of water is coming from the washdown nozzle, release the spray nozzle. As the pressure builds, the pump will automatically shut off at 35 psi.

When properly primed and activated, the pressurized water system can be used in the same manner as the water system in a home. An automatic pressure sensor in the water pump keeps the system pressurized. Simply operate the spray nozzle and water will be delivered. If the system has been recently filled, or has not been used for an extended period of time, air bubbles may accumulate at the pump. If this should happen, re-priming may be necessary.

J - 4 HEADS

A. Candia FS Enclosed Heads

On all Candia FS models, an enclosed head is a standard feature. These roomy heads offer shelf storage, lighting, opening port light, and removable carpet. Also found in the head of a 234/254 is a sink. The head location for the 214 CFS is in the front portion of the starboard console, while the 234/254 CFS heads are located in the rear portion of the port console. See Figure J4.

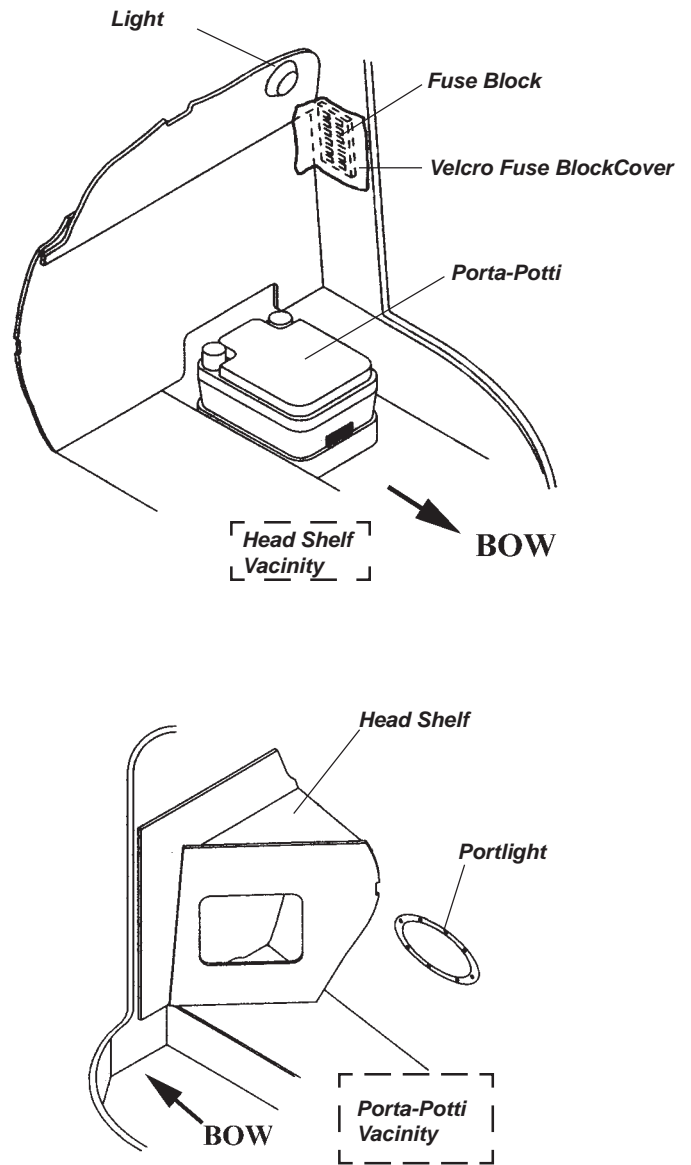

Figure J4: 214 Candia FS Enclosed Head Views

B. Pump Out Option

When equipped with the pump out option, the waste can be removed from the tank at a pumping station. A deck plate fitting labeled WASTE, is provided for this purpose. The pump out option is available on all Candia FS models. Most marina fueling facilities provide service for waste pump out.

To pump out the holding tank:

1. Connect the dockside pump out connection to the WASTE plate located on the deck.

NOTICE

Usually the dockside pump out connection will screw into the waste deck plate or has a rubber sleeve that inserts into the plate and must be held in position during the pump out operation.

2. Have the pumping station operator activate the pumping equipment. The waste will be drawn from the holding tank and into the pumping stations disposal tank.
3. Remove the pump out connection from the deck plate. Add 1 gallon of clean water to the holding tank through the waste deck fitting using a dockside water hose.
4. Repeat steps 1 & 2 above to pump out the water used in step 3 to flush the holding tank.
5. Add waste holding tank treatment chemical available from the dockside pumping station operator to the head. Flush at least twice.

 **CAUTION**

Be careful when handling and storing treatment chemicals. Not only are they toxic, but they will also stain and damage surrounding surface.

It will be necessary to remove the top holding tank of the portable head to fill with water.

J - 5 SYSTEM MAINTENANCE

Be sure the batteries in the boat are properly charged. Operating the pressure pump from a battery with a low charge will result in pump cycling. This could lead to premature pump failure.

 **WARNING**

The decomposition of waste produces a colorless, odorless gas, methane, that is lighter than air, combustible, and extremely lethal. Always provide sufficient ventilation when effecting repairs to the waste system and allow no odor from the waste system to go unresolved.

A. Clean Vents and Screens

Periodically remove the vent caps and check the water tank vent(s). Clean the thru-hull vent fitting(s) of any dirt, wax, plastic particles, etc. Always replace the caps after cleaning.

NOTICE

Failure to keep the water tank vent fitting clean will cause excessive pressure buildup within the tank during filling. This can cause water tank damage.

B. Winterizing the Water System

Winter lay-up service procedures should include a thorough draining of the water system. Disconnect all accessible fittings. Blow out all lines. Be sure the water tank, waste tank, pumps and lines are completely dry. Freezing water can cause severe damage to all water system components.

NOTICE

It may be necessary to disconnect the hose below the faucet to remove excess water in the lines to prevent freeze damage.

NOTICE

Always winterize the fresh water system prior to winterization of the hull drainage (bilge pump) system.

Draining the system as mentioned can be very tedious and an incomplete job can result in expensive repairs. The use of nontoxic antifreeze (such as R.V. antifreeze) designed for fresh water systems considerably reduces the work necessary and is a more positive means of winterizing the system. Follow the directions included with the antifreeze solution.

To winterize:

1. Turn on the water pump/faucet and drain the water tank. The water tanks on some models can be drained by removing the withdrawal hose from the tank and allowing water to drain into the bilge.

NOTICE

DO NOT run the water pump without water in the system. Pump damage can result. Be watchful and turn the pump off as soon as the tank becomes empty.

2. Add 1/2 gallon of R.V. antifreeze to the water tank.
3. Turn ON the pump until undiluted antifreeze is seen.



DANGER

Use only nontoxic antifreeze solutions such as R.V. antifreeze. DO NOT use ethylene glycol solutions; the type that is used in engine coolant systems. These are toxic.

NOTICE

Be sure to wipe up any antifreeze that has been spilled on the fiberglass surfaces to prevent possible discoloration or damage to the gel coat.

Depending upon options and model, additional information by the equipment manufacturers is included in the owner's packet. Also, refer to Section R for Maintenance.

WATER SYSTEM

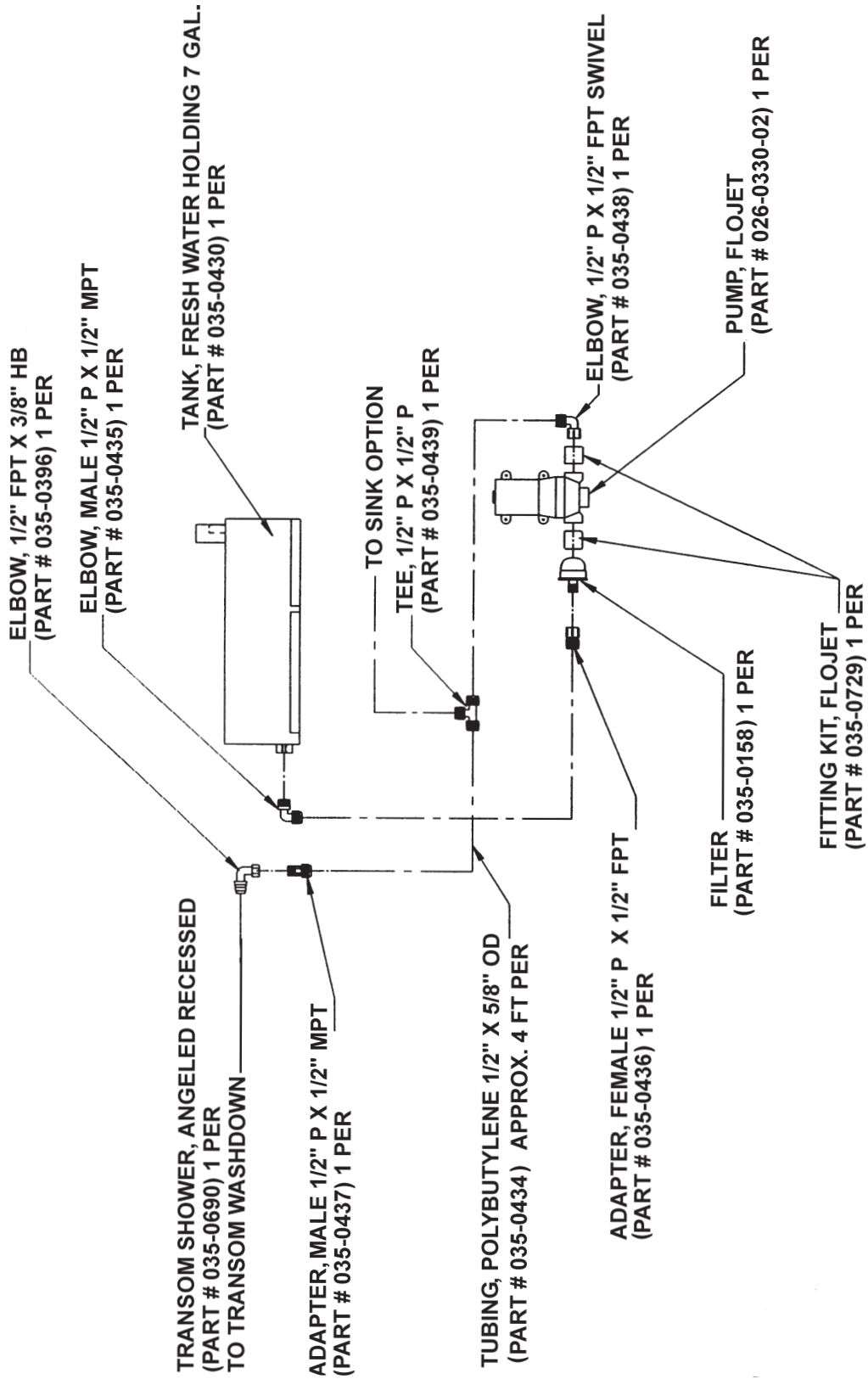

Figure J5: General Water System Diagram

VENTILATION & DRAINAGE SYSTEMS

K - 1 ENGINE COMPARTMENT VENTILATION

All Four Winns® stern drive models are equipped with engine compartment ventilation. This system is designed to meet or exceed the requirements (in effect at the time of manufacture) of the U.S. Coast Guard, the National Marine Manufacturers Association, and the American Boat and Yacht Council.

A. Gravity Ventilation System

This system includes air intake and exhaust components. The exhaust ducting reaches to the lower bilge area. This provides adequate air movement while underway and during bilge blower operation.

B. Forced Air Ventilation

All Four Winns® models except outboards are equipped with an electric bilge blower. The bilge blower provides the ventilation required prior to starting the engines and while at idle. See Section H Electrical Systems for blower operation instructions.

 **WARNING**

Gasoline vapors can explode resulting in injury or death. Before starting the engine, check the engine compartment bilge for gasoline or vapors, and operate blower for four (4) minutes, and verify blower operation. Run blower when vessel is operating below cruising speed. ALWAYS operate the bilge blower while the engines are at idle.

NOTICE

A Gas Vapor Detector is a monitor which will alert the operator of an accumulation of gasoline fumes in the engine compartment. It is optional only on larger models but can be installed by your Four Winns® dealer. DO NOT rely solely on detectors or similar equipment. ALWAYS conduct a physical inspection of the engine compartment.

C. Engine Ventilation System Maintenance

Periodic inspection and cleaning of the ventilation ducts is necessary to ensure adequate air circulation. A buildup of leaves, twigs, or other debris can severely reduce ventilation. Be sure bilge water does not accumulate to a level that would obstruct the ventilation ducts.

Blower operation can be tested by placing a hand over the vents. DO NOT rely on the sound of the blower. Be sure a substantial amount of air is being exhausted by the bilge blower. Check the bilge blower system often, preferably before each cruise.

Should blower noise and vibration be excessive, loosening the bilge blower mounting screws and then tightening evenly usually reduces noise considerably.

K - 2 HULL DRAINAGE SYSTEMS

A. Transom Drain

A transom drain with plug is provided in the engine compartment to allow water drainage. When the boat is out of the water, the boat and trailer should be positioned so any bilge water accumulation during dry storage will flow towards the transom.

 **CAUTION**

Be sure the drain plug is securely in place prior to launching the boat. Upon shipment of the boat, the drain plug is usually taped to the steering wheel.

B. Bilge Pumps

Bilge pumps are provided in the bottom of the hull to remove miscellaneous water accumulations that might occur during normal boating or weather conditions. The bilge pump is controlled by the Bilge Pump Switch on the dash panel. See Section H-3 for a detailed description of the bilge pump switches.

Bilge pumps equipped with automatic switches are standard on all Candia FS models. As the water level rises, the automatic float switch will activate the pump.

When leaving the boat unattended for long periods of time or during excessive rain storms, it is a good idea to check on the boat for excessive water accumulation. Be sure the bilge pump and automatic float switch (if equipped) are operating properly. The operating time of the bilge pump will be limited to the battery capacity.

NOTICE

While at rest, any bilge water accumulation may flow forward. Therefore, operate the bilge pump shortly after getting underway and while the boat is at a substantial running angle. **DO NOT** allow bilge water to accumulate. Damage to the engine or other components may result.

Periodically, clean the bilge pump strainers. **DO NOT** allow dirt and debris to clog the bilge pump intakes. Check operation of the bilge pump float switch often to ensure movement of the switch is not restricted by debris, portions of the hull, etc.

Wipe up any oil accumulation in the bilge prior to activation of the bilge pump. Pumping oil overboard will pollute the water, and is subject to fine.

After winterization of the fresh water systems, be sure the bilge area, bilge pump and associated hoses are thoroughly dry. Damage to the hull, bilge pump and other equipment could occur if water is allowed to freeze in the bilge.

C. Liner Drains

Liner drains are provided on models with fiberglass liners or floors. Fiberglass liners can be cleaned easily by hosing the floor. The water will drain into the bilge and be pumped overboard.

D. Bilge Compartment Drainage

Certain bulkhead areas of Four Winns® boats are sealed in accordance with U.S. Coast Guard regulations effective at the date of manufacture. Drainage is provided and water can be removed with the bilge pump.

INTERIOR EQUIPMENT

L - 1 PORT CONSOLE COOLER - 214 CFS

The 214 Funship has an integrated cooler for the storage of soft drinks. The cooler is located in the port console immediately forward of the sink. The excess water from melting ice will drain overboard. The lid consists of starboard material and includes a finger-pull to allow easy access. See Figure L1.

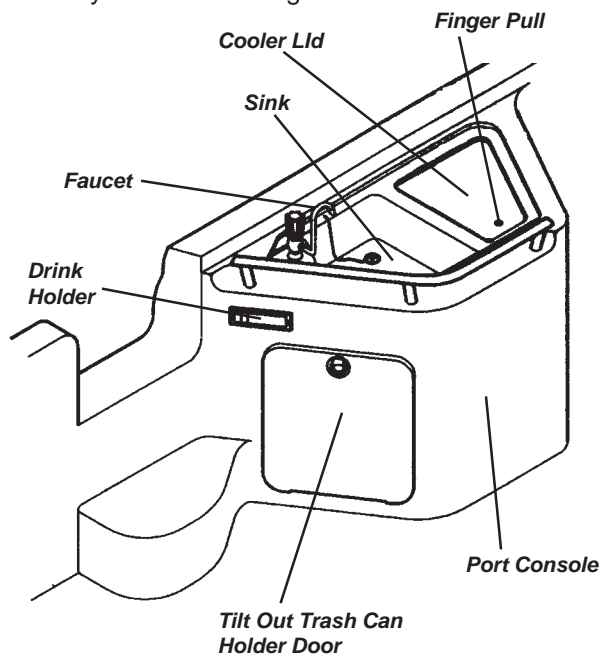

Figure L1: 214 Candia FS Port Console

L - 2 BUILT-IN ICE CHEST - 234/254 CFS

The 234/254 Candias have a built-in ice chest located in the bow, underneath the center bow cushion. Along with the ice chest, a 36 quart removable cooler (the 254 comes equipped with two) is included. The cooler can be stored under the port aft bow cushion. The 254's additional cooler is stored in a specially designed cooler insert underneath the entertainment center. See Figure L2 & L3. The 254 also has another built in ice chest/storage compartment located between the two bucket seats.



Removable Cooler

Figure L2: 234/254 Candia Cooler Storage



Figure L3: 254 Candia Entertainment Center

L - 3 ENTERTAINMENT CENTER - 254 CANDIA FS

The 254 Candia FS comes equipped with an entertainment center located on the starboard side, behind the helm seat. The entertainment center includes a removable cooler, trash receptacle, covered sink, and additional storage. See Figure L3 and Section J-3B for more details.

L - 4 HEADS

On all Candia FS models, an enclosed head is a standard feature. These roomy heads offer shelf storage, lighting, opening port light, and removable carpet. Also found in the head of a 234/254 is a sink. The head location for the 214 CFS is in the front portion of the starboard console, while the 234/254 CFS heads are located in the rear portion of the port console. See Figure L4 & L5.

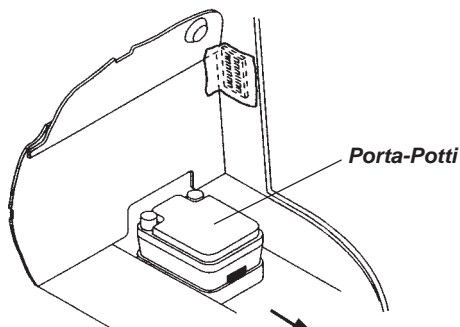

Figure L4: 214 Candia FS Enclosed Head



Figure L5: 234/254 Candia FS Enclosed Head

L - 5 STEREO

Four Winns® offers a CD stereo as standard equipment on the all of the Funships. The stereo is mounted within a plastic box to protect it from the elements. The radio box has a sliding door to allow access to the controls.

The speakers are installed within coaming (side upholstery) pads or seat bases.

For additional information on stereos, refer to Section H-3C of this manual and the manufacturer's literature included in the owner's packet.

L - 6 CHERRY HELM ENHANCEMENTS

A standard feature Candia FS models is the cherry wood grain accent. This consists of finished synthetic cherry for the instrument panel or dash module, ignition switch panel, and emergency switch panel. For care and upkeep information, refer to Section Q-3 Cherry in this manual.

L - 7 ANCHOR/LADDER STORAGE

The Candia FS models have a built-in anchor/ladder locker. It is located at the bow of the boat. Simply lift the anchor lid to gain access to the anchor/ladder locker. The ladder located inside is a 4-step ladder which provides a deep-reach and allows for easier boarding. The anchor/ladder lid provides hand holds that make boarding simple. See Figure L6 below and Section M-1E for additional information.



Figure L6: Candia FS Bow Ladder

L - 8 SKI STORAGE LOCKER

A standard feature on all Candia Funships is an in-floor ski locker. The locker allows for storage of skis, tow ropes, personal floatation devices, etc. The ski storage lid is hinged for ease of use and will stay in place in choppy water. See Figure L7.



Figure L7: 234/254 Candia FS Ski Locker

L - 9 BOW STORAGE

The port and starboard bow seat cushions are either hinging or removable on all Funship models. Underneath each cushion is additional storage for all types of gear.

L - 10 BOW FILL-IN CUSHIONS

With the optional bow fill-in cushions you can turn the bow of your Candia into a sundeck. These bow fill-in cushions can be easily removed or installed in a matter of minutes. The bow cushions may be stored in the head compartment on the 214 CFS and on the 234/254 they are stored in the starboard storage locker. Contact your Four Winns® dealer and he will be glad to order them for you.

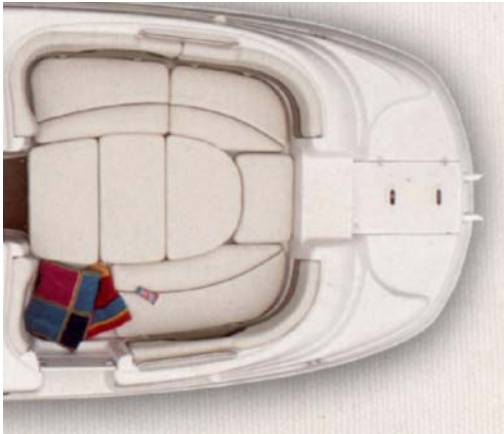

Figure L8: Candia FS Bow Fill-In Cushions

L - 11 STERN SEAT STORAGE

Additional storage space is provided under the stern seating area. This allows you to hide necessary equipment without taking up usable space. See Figure L9.



Figure L9: Stern Seat Storage

L - 12 STARBOARD STORAGE LOCKER

The 234 and 254 Funships feature a starboard console storage locker. The storage locker provides the storage space needed for all the essentials one needs to make an all day boating adventure a success. See Figure L10.



Figure L10: 234/254 CFS Starboard Console Storage

L - 13 SWIM PLATFORM - STERN LADDER

Four Winns® provides an integrated fiberglass swim platform on all models. For better footing, a nonskid surface is provided. The swim platform is recessed for the ladder and a hinging ladder lid is provided. With this design, the ladder is concealed and you do not lose valuable platform space.

The ladder is “deep” and “angled” mounted which makes it easier to climb. Its starboard location means you’re not approaching a down skier on your “blind side”.

 **WARNING**

Keep hands and fingers away from ladder hinges to prevent injury.

 **DANGER**

NEVER APPROACH OR USE LADDER WHEN THE MOTOR IS RUNNING. SEVERE INJURY OR DEATH WILL RESULT FROM CONTACT WITH ROTATING PROPELLER.

! DANGER

Shut off motor when near swimmers. Severe injury or death will result from contact with rotating propeller.

NOTICE

Always secure the ladder before boating. Damage to the ladder may otherwise result.

! DANGER

To prevent personal injury, swim platform must not be occupied and transom door must be closed while engines are running.

! CAUTION

To prevent personal injury, DO NOT sit on or lean against the transom door.

L - 14 TRANSOM DOOR - SIDE DOOR

A transom door is provided and allows access from the swim platform to the cockpit. For access on or off the boat, either a port or starboard side door is standard. A slide bolt is used to secure both the transom and side door. To prevent a possible man overboard situation, make sure the transom and side doors are secure before each cruise. See Figure L11.

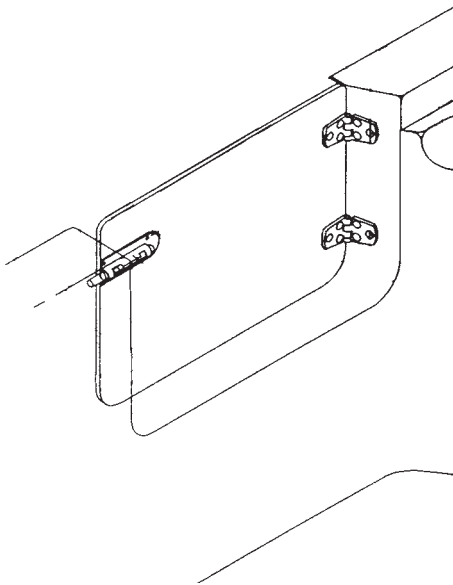

Figure L11: 214 CFS Port Side Door

! WARNING

Prevent falls overboard. Close, latch, and stay inside gate(s) while underway.

L - 15 WALK-THROUGH DOOR - 234/254 CFS

An optional walk-through door is available on the 234/254 Candia FS. The walk-through doors are designed to keep out the wind and weather, making for a warmer cockpit area. Please contact your Four Winns® dealer if interested in adding this option. See Figure L12.

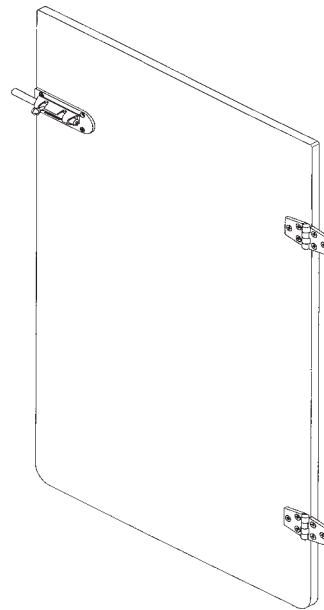

Figure L12: 234/254 CFS Walk-Through Door

EXTERIOR EQUIPMENT

M - 1 RAILS & DECK HARDWARE

A. Rails

Grab handles have been installed to provide security for passengers in the cockpit. Limiting passenger movement while underway is recommended. All those on board should be safely seated whenever possible. Additional care must be taken when in rough seas or foul weather.

The rail system and hardware fittings have been selected and installed to perform specific functions. Fenders or mooring lines should not be secured to the rails or stanchions. Be certain that a clear lead exists when running dock lines or an anchor line. A line inadvertently threaded around a stanchion or over the rail could cause damage.

B. Cleats

The cleats that have been installed are specifically designed and are intended to be used as mooring cleats. Their purpose is for securing the vessel to a dock, pier, mooring, or anchor.



WARNING

Four Winns® Boats are not equipped with any hardware designed for towing purposes. The mooring cleats that are installed on the boat are not to be used for towing another vessel or having the boat towed. Refer to Section A Operation for additional precautions regarding ground- ing and towing.

C. Transom Ski Tow Ring

The transom ski tow ring is mounted on the transom above the integrated platform. It is available on all models except outboards. All these models should pull up two skiers under normal boating conditions. However, Four Winns® recommends no more than two skiers be pulled behind the boat at any time.

D. Ski Pylon - 214 CFS Outboard Model

The ski pylon is optional for the 214 Candia FS outboard model. The ski pylon is mounted at the transom. The pylon can be easily removed for storage.



WARNING

Do not use ski tow fitting for lifting or parasailing. Fitting could pull out of deck resulting in serious injury or death.



WARNING

To prevent personal injury or damage to the boat, DO NOT tow more than two water skiers with the transom mounted ski tow ring.

NOTICE

Skier's weight, boating conditions, amount of gear, and operator's experience will affect the number of skiers which can be pulled.

E. Anchor/Ladder Locker

The Candia FS models have a built-in anchor/ladder locker. It is located at the bow of the boat. Simply lift the anchor/ladder lid to gain access to the anchor locker. The compartment should be inspected after each use, and kept clean of dirt and debris to prevent plugging of the drain hole. For information on anchors, refer to Section M-5.

F. Maintenance

The majority of the hardware installed is made of stainless steel. Regardless of the type of hardware used, periodic maintenance is necessary.

The manufacturer of our hardware recommends the following when washing your boat:

1. Rinse the hardware with fresh water after each exposure to saltwater.
2. Periodically wash the hardware with mild soap, warm water, and a sponge. Then dry it with a soft cloth.
3. Avoid cleaners, abrasives, waxes, and most of all, do not use steel wool.

NOTICE

All fittings must be periodically inspected for loosening, wear, and damage. Problems should be corrected immediately!

M - 2 WINDSCREENS & WINDSHIELDS

Depending on the model, a windscreen or windshield is standard equipment. The 214 has a plexiglass windscreen on the driver's console. The 234/254 has a full windshield consisting of tempered safety glass and the windshield frame is aluminum.

Plexiglass windscreens and windshields of tempered glass can be cleaned with automotive glass cleaners or dishwashing soap and water. Ensure that a clean cloth is used to prevent scratching the plexiglass.

Aluminum can be cleaned with similar products or with nonabrasive cleaners such as Fantastik™.

NOTICE

Read the label before using any product. DO NOT use abrasive cleaners.

M - 3 SWIM PLATFORM

Four Winns® provides an integrated fiberglass swim platform on all models. For better footing, a nonskid surface is provided. The ladder is "deep" and "angled" mounted which makes it easier to climb. Its starboard location means you're not approaching a down skier on your "blind side".

 **WARNING**

Keep hands and fingers away from ladder hinges to prevent injury.

 **DANGER**

NEVER APPROACH OR USE LADDER WHEN THE MOTOR IS RUNNING. SEVERE INJURY OR DEATH WILL RESULT FROM CONTACT WITH ROTATING PROPELLER.

 **DANGER**

Shut off motor when near swimmers. Severe injury or death will result from contact with rotating propeller.

NOTICE

Always secure the ladder before boating. Damage to the ladder may otherwise result.

M - 4 TRANSOM DOOR - SIDE DOOR

A transom door is provided and allows access from the swim platform to the cockpit. For access on or off the boat, either a port or starboard side door is standard. A slide bolt is used to secure both the transom and side door. To prevent a possible man overboard situation, make sure the transom and side doors are secure before each cruise.

 **WARNING**

Prevent falls overboard. Close, latch, and stay inside gate(s) while underway.

 **DANGER**

To prevent personal injury, swim platform must not be occupied and transom door must be closed while engines are running.

 **CAUTION**

To prevent personal injury, DO NOT sit on or lean against the transom door.

M - 5 ANCHOR

Four Winns® recommends an eight (8) pound, Attwood® "Penetrating" anchor, with a 3/8" line be used on all the Candia FS models. The recommended line length is 100-150 feet. Because of differences in style, a larger anchor may be needed for different bottom or boating conditions.

NOTICE

A "system matched*" fluke style anchor fits in all applications. *"System matched" means that the designated OEM part, anchors in this instance, found in an OEM parts catalog would work in this application.

Anchors are usually a dealer installed option. Please check with your Four Winns® dealer for his recommendations.

M - 6 DEPTHSOUNDER

The depthsounder is standard equipment on all the Candia FS models. The depthsounder has both audible and visual alarms. See Sections E-6H - E-6J of this manual for additional information.



WARNING

Do not rely on depthsounder to avoid submerged objects. Depth sounders provide a relative indication of water depth only.

NOTICE

DO NOT depend solely upon the depthsounder for water depth. It is important to have navigational charts of the waters in which you are operating.

UPHOLSTERY

N - 1 EXTERIOR SEATING

A. Cockpit Tables

An aft cockpit table with mount is available as standard equipment on all Candia Funship models. Table bases are “flush” mounted for convenience and safety. Table legs are removable for easy storage. To remove the table leg, simply unscrew the leg from the floor mount. See Figure N1.



Figure N1: Aft Cockpit Table

B. Bow Table - Optional

An optional bow table is available on all Candia FS models. This table provides convenient table space in the bow area utilizing a special mounting bracket. This bracket allows for the positioning of the table as desired. The table may also be folded down out of the way when not in use, or can be easily removed from the mounting plate and stored altogether. See Figure N2.

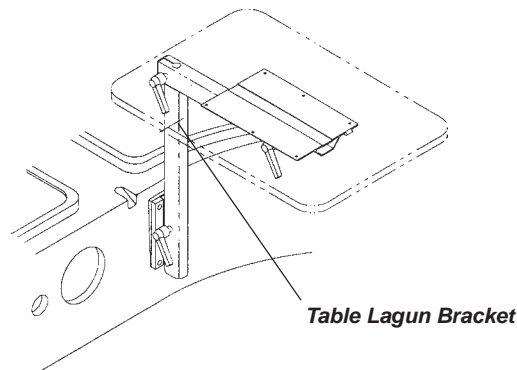

Figure N2: Bow Table

C. Bow Seating

Bow seating is provided on the Candia FS models. Certain cushions on the 234/254 CFS have hinges to allow access to storage areas below. The 214 Candia FS has removable cushion for accessing the storage areas below. See Figure N3.



Figure N3: 254 CFS Hinging Bow Seat

Bow fill-in cushions are optional on the Candia FS. When installed, the fill-in cushions help form a berth across the bow area. These cushions may be stored in the walk-thru storage or head areas. See Figure N4.

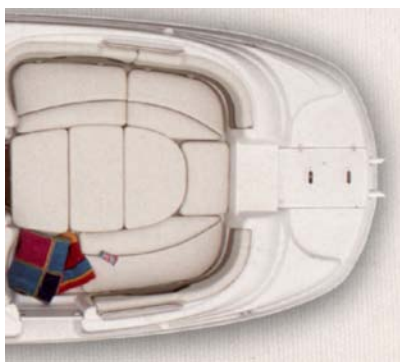

Figure N4: 234254 CFS Fill-In Cushions

D. Helm “Buddy” Seat

Standard on the 214 Candia FS, I/O model only, is a double wide helm seat. It is referred to as the “Buddy” seat because a second person may sit next to the driver. The seat can be swiveled towards the stern 90° thus making the cockpit cozier and much easier to interact with your guests. See Figure N5.



Figure N5: 214 CFS I/O “Buddy” Seat

The “Buddy” seat is also adjustable forward or back. To adjust, locate the left locking lever under the front of seat. Push the lever to the left and slide the seat forward or aft to the desired position. The seat will adjust approximately six (6) inches. See Figure N5.

To swivel the “buddy” seat:

1. Place the tilt wheel in its most upward position by depressing the release lever (adjusting tab) with your thumb. Be sure to hold the top of the wheel to assist in positioning. Release the lever once the steering wheel is in its most upward position.

2. Locate the left locking lever under the front of seat. Push the lever to the left and slide the seat forward.

NOTICE

When attempting to swivel, ensure the “buddy” seat clears the coaming pad otherwise, damage to the coaming pad and/or “buddy” seat will occur.

3. Locate the right most lever under the front of the seat (swivel release) and push it to the left.
4. Swivel the seat inboard (the only direction possible). The seat will rotate approximately 90°.

To return to forward driving position:

1. Rotate the buddy seat outboard (the only direction possible) until the swivel seat mechanism locks into place.
2. Position the seat according to the needs of the driver by locating the left locking lever under the front of seat. Push the lever to the left and slide the seat forward or aft to the desired position.
3. Tilt the steering wheel to the desired position using the tilt lever knob on the steering column.

E. Bucket Seats

The bucket seat or captain’s chair is adjustable. To adjust, lift up on the metal release handle under the middle of the seat. Slide the seat forward or aft to the desired position. The seat will adjust approximately six (6) inches. See Figure N6.

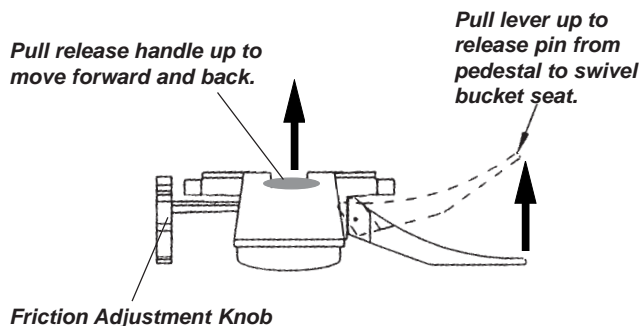

Figure N6: Bucket Seat Slider Base (Front View)

The driver’s side and the port side (if applicable) can swivel and face the stern of the boat. When pulling a water skier, this permits the spotter to be in the proper position to observe.

Also available, is an optional bucket seat with flip-up bolster. By simply flipping up the bolster the driver is able to sit higher in the seat. This is designed to give the driver greater flexibility, increased visibility, and riding comfort.

1. 234 Candia Starboard Bucket Operation

To rotate the the starboard (driver's) bucket seat to face aft:

1. Place the tilt wheel in its most upward position by depressing the release lever (adjusting tab) with your thumb. Be sure to hold the top of the wheel to assist in positioning. Release the lever once the steering wheel is in its most upward position.
2. Locate the lever on the left side of the slider mechanism and pull to release the pin from the pedestal. This will allow you to rotate the seat. See Figure N6.
3. Rotate the bucket seat counterclockwise (inboard) 180°. In addition, DO NOT USE FORCE to rotate the chair.

NOTICE

When rotating the driver's side (starboard) bucket, damage to seat, steering wheel, and/or coaming pad may result if attempting to rotate in the wrong direction, with the steering wheel not tilted up, and/or over-rotating. DO NOT USE FORCE to rotate the chair.

To return the starboard (driver's) bucket seat to the bow facing position:

1. Rotate the bucket seat clockwise (outboard) 180° until the seat mechanism locks into place. In addition, DO NOT USE FORCE to rotate the chair.

NOTICE

When rotating the driver's side (starboard) bucket, damage to seat, steering wheel, and/or coaming pad may result if attempting to rotate in the wrong direction, or with the steering wheel not tilted up, and/or over-rotating. DO NOT USE FORCE to rotate the chair.

2. Position the seat according to the needs of the driver by lifting up on the release handle under the middle of the seat. See Figure N6.

3. Tilt the steering wheel to the desired position using the tilt lever knob on the steering column.

2. 254 Candia Starboard Bucket Operation

To rotate the starboard (driver's) bucket seat to face to the aft:

1. Place the tilt wheel in its most upward position by depressing the release lever (adjusting tab) with your thumb. Be sure to hold the top of the wheel to assist in positioning. Release the lever once the steering wheel is in its most upward position.
2. Slide the seat completely forward by lifting up on the release handle under the middle of the seat. See Figure N6.
3. Locate the lever on the left side of the slider mechanism and pull to release the pin from the pedestal. This will allow you to rotate the seat. See Figure N6.
4. Rotate the bucket seat counterclockwise (inboard) until it faces the aft position. In addition, DO NOT USE FORCE to rotate the chair.

NOTICE

When rotating the driver's side (starboard) bucket, damage to seat, steering wheel, and/or coaming pad may result if attempting to rotate in the wrong direction, or with the steering wheel not tilted up, or over-rotating, and/or with the seat not fully forward. DO NOT USE FORCE to rotate the chair.

To return the starboard (driver's) bucket seat to the bow facing position:

1. Rotate the bucket seat clockwise (outboard) 180° until the seat mechanism locks into place. In addition, DO NOT USE FORCE to rotate the chair.

NOTICE

When rotating the driver's side (starboard) bucket, damage to seat, steering wheel, and/or coaming pad may result if attempting to rotate in the wrong direction, or with the steering wheel not tilted up, or over-rotating, and/or with the seat not fully forward. DO NOT USE FORCE to rotate the chair.

2. Position the seat according to the needs of the driver by lifting up on the release handle under the middle of the seat. See Figure N6.
3. Tilt the steering wheel to the desired position using the tilt lever knob on the steering column.

To rotate the port (passenger) bucket seat to face aft:

1. Slide the seat completely forward by lifting up on the release handle under the middle of the seat. See Figure N6.
2. Locate the lever on the left side of the slider mechanism and pull to release the pin from the pedestal. This will allow you to rotate the seat. See Figure N6.
3. Rotate the bucket seat clockwise (inboard) until it faces the desired aft position. **DO NOT USE FORCE** to rotate the chair.

NOTICE

When rotating the port side bucket, damage to seat and/or coaming pad may result if attempting to rotate in the wrong direction, or over-rotating, and/or with the seat not fully forward. **DO NOT USE FORCE** to rotate the chair.

To return the port (passenger) bucket seat to the bow facing position:

1. Rotate the bucket seat counterclockwise (outboard) until the seat mechanism locks into place. In addition, **DO NOT USE FORCE** to rotate the chair.

NOTICE

When rotating the port side bucket, damage to seat and/or coaming pad may result if attempting to rotate in the wrong direction, or over-rotating, and/or with the seat not fully forward. **DO NOT USE FORCE** to rotate the chair.

2. Position the seat according to the needs of the individual by lifting up on the release handle under the middle of the seat. See Figure N6.



WARNING

DO NOT sit on the backrest portion of any cockpit seat. The helmsman could lose control of boat or passengers could be thrown from boat. Also, the seat may be damaged from improper use.

F. L-Shaped Lounger Seating

L-shaped seating is found in all Candia FS models. Large amounts of storage space is located under either the removeable seat cushions (214) or the hinged seat cushions (234/254). To assist you when placing or removing items from the storage compartments hydraulic lifts have been provided on the 234/254 Candia FS models.

G. Motorbox (Engine Covers)

The motorbox is incorporated in the L-shaped seating arrangement. To gain access to the engine follow the instructions below for the different models.

1. 214 Candia FS:

- a. Lift up on the top storage cushion strap and move the cushion up and back out of the way. This cushion is attached by hinges which prevent the cushion from being lost overboard. This step alone will allow you limited access to the engine compartment.
- b. To gain greater access to engine compartment, undue the white shock cord (bungee cord) from the knob.
- c. Lift the motorhood upward by placing your hands underneath the middle of the motorhood backrest. Lift evenly. Two gas shocks will assist in raising the motorhood and holding it in place will work is being performed.

To lower the motorhood, simply reverse the process.

NOTICE

Ensure to place the shock cord strap around the knob before operating. Also ensure the top storage cushion is properly seated. This will prevent damage to motorhood and/or top storage cushion while underway.

2. 234/254 Candia FS:

- a. Release the motorhood locking lever by pushing in on the button on the lever itself. Make sure to open the locking lever completely.
- b. Once the locking lever is released, place your fingers inside the detent of the locking lever, and pull the motorhood forward, gently, until it rest on the cockpit floor. The motorhood is hinged which makes the opening and closing easy.

To lower the motorhood, simply reverse the process.

NOTICE
Do not allow the motorbox cover to “slam” shut. Gently guide the motorbox into the “closed” position. Allowing the motorbox to “slam” shut can damage the fiberglass motorbox.

NOTICE
Upon closing, ensure to secure the motorhood by placing the locking lever in the locked position by simply pushing down on the lever. This will prevent the motorbox from vibrating and loosening the hinge screws.

NOTICE
Never operate your boat with the engine lid in its open position. Doing so could result in damage or loss of cushion and hardware. This is also true when trailering your boat. **Cushions, if not properly stored and secure, will blow out of the boat.**

N - 2 EXTERIOR UPHOLSTERY CARE

The vinyl material used on the exterior upholstery can be easily cleaned using mild detergent and water. Be sure to thoroughly rinse the seats after washing to remove all soap film. Periodic spraying of the seats with Lysol Spray Disinfectant™ will help retard mildew.

NOTICE
DO NOT apply vinyl protectants such as Armorall™. The manufacturer does not recommend this product because it removes the oils present in vinyl that keeps vinyl soft.

A recommended “Cleaning Kit” includes:

- Ivory Dishwashing Liquid™ and water
- Clean, white towels
- Medium-soft brush
- Fantastik Spray Cleaner™
- Denatured Alcohol
- Tough Duty Cleaner™
(to locate the nearest distributor, call 800-537-8990)
- Ammonia and hydrogen peroxide

To remove stains, follow the guidelines below.

1. Basic Stains/Grease/Pencil/Dirt:

Ivory Soap™ and water or Fantastik Spray Cleaner™ applied with a medium-soft brush.

2. Tough Stains/Adhesive/Teak Oil/Rust:

Tough Duty Cleaner™, rinse with soap and water.

NOTICE
To prevent possible damage to the vinyl, rinse with soap and water after applying the Tough Duty Cleaner™.

3. Ink:

Denatured alcohol.

4. Mildew Stains:

To kill bacteria creating the mildew, vigorously brush the stained area with a 4-to-1 mixture of water and ammonia; rinse with water.

5. Tough Mildew Stains:

Apply a mixture of one (1) teaspoon ammonia, one-fourth (1/4) cup of hydrogen peroxide, and three-fourths (3/4) cup of distilled water; rinse with water.

NOTICE
ALWAYS CLEAN STAINS IMMEDIATELY! DO NOT use 409 Cleaner™ or Armorall™ on vinyl. All cleaning methods must be followed by a thorough rinse with water.

Certain household cleaners, powdered abrasives, steel wool and industrial cleaners can cause damage and discoloration and are not recommended. Dry cleaning fluids and lacquer solvent should not be used as they will remove the printed pattern and gloss. Waxes should be used with caution. May contain dyes or solvents that can permanently damage the protective coating.

Additional cleaning information is provided by the manufacturer and is included with this manual.

Four Winns® offers a variety of optional weather covers for protection of the boat and associated equipment. Continued exposure can damage the upholstery and seating. The seating can become thoroughly saturated with water if not adequately protected. Refer to Section O on Weather Covers for more information.

NOTICE

The appearance and longevity of the exterior upholstery will be affected by water saturation. Protect these items appropriately.

N - 3 REPLACEMENT UPHOLSTERY

Should upholstery become severely soiled, torn, or in some manner damaged, replacement upholstery cushions are available. Larger upholstery items have separate component parts for easier serviceability.

Depending upon the year and model of the boat, most upholstery parts can be obtained through your Four Winns® servicing dealer within a short period of time.

N - 4 CARPET CARE

A. Interior and Exterior Carpet

Four Winns® Sport Boat models use a high quality grade carpeting in the cabin and cockpit. Vacuuming and occasional rug shampooing are recommended for extended life and appearance. It is 100% UV stabilized Olefin™ Polypropylene fiber.

The optional snap-in carpet for the cockpit with fiberglass liner is also made of 100% UV stabilized Olefin™ Polypropylene fiber. This is an exterior grade, high quality carpet with rubber-type backing.

NOTICE

DO NOT dry carpeting in an automatic dryer.

The snap-in carpet may be periodically washed with mild laundry soaps or shampooed, dried and reinstalled. Additional information is listed below.

B. Cleaning and Maintenance

The following information should be useful in helping you keep your carpet looking well maintained.

Carpet made with Olefin™ fiber possesses built-in stain and soil release for easy, less costly maintenance. Regular vacuuming and occasional shampooing help it stay attractive and serviceable.

C. Stain Removal Testing

Even the most stubborn stains can be removed from Olefin™ fiber following the procedures outlined. A total of thirty-four stains were selected as being representa-

tive of spills commonly occurring on carpets. Stains were pressed into the carpet to simulate foot pressure following a spill. Stains were applied to a two-inch square section and allowed to penetrate. Removal was performed after two weeks. Carpets were tested for stain removal by an independent laboratory. Stain removal was effective for all 34 stains. Results are shown in the table.

D. Stain Removal Procedure

Regular maintenance such as vacuuming, hosing or washing should be performed. Most stains and mildew are easily removed from carpet made with Olefin™ fiber using common household cleaners. Refer to Table I. Olefin™ fiber is so resistant to chemical attack that Clorox Bleach™ may be used to clean up any mildew that may result from excessive wetness.

Code for stain removal procedure (See Table 1):

“A” Apply hot water and detergent.

“B” Apply volatile dry solvent, work with bone spatula, blot.

“C” Flush by hot water extraction.

Recommended reagents:

- Carpet detergent such as Mintex™ (Hydromaster®) or any carpet detergent suitable for hot water extraction.
- Volatile dry solvent such as Carbona™, Energene™, or Picrin™ (Street®).
- Oily type paint remover such as nail polish remover, Energene™ or Pyrotex™ (Street®).
- Neutral lubricant such as Streetex Spray Spotter™ (Street®) or alternate treatment with detergent and Energene™.

STAIN	REMOVAL PROCEDURE
Automotive Grease	A
Automotive Oil (New or Used)	A
Bacon Grease	A
Berry Stain	A
Blood	A
Butter	A
Catsup or Mustard	A
Chewing Gum	A, B (Repeat)
Chlorine Bleach (5%)	A
Chocolate (Melted)	A
Clay (Red)	A
Coffee or Tea	A
Cola	A
Crayon	A, B, C
Egg	A
Feces	A
French Dressing	A
Furniture Polish	A
Grape Juice	A
Gravy	A
Ink (Permanent Black)	A, B, C
Ink (Scripto, Ballpoint)	A, B, C
Iron Rust	A
Lipstick	A, B
Mayonnaise	A
Milk	A
Shaving Cream or Lotion	A
Urine	A
Vomit	A
Wine	A

Table I: Stain Removal

WEATHER COVERS

O - 1 GENERAL INFORMATION

Weather covers for the cockpit areas are available on all Candia FS models. Four Winns® covers are designed and intended to provide protection of the cockpit seating areas.

Four Winns® utilizes acrylic-type material for all its covers. All Sport Boat canvas except mooring covers consist of 100% acrylic material and is color matched to the boat. The mooring covers are made of 10 ounce acrylic and come in dark tan (mica) only.



WARNING

Never use any form of open flame cooking device while under, in any area fully enclosed, or near any acrylic weather cover. This material is flammable.

During the manufacture of the weather covers, the smallest possible needle and highest quality UV stabilized, bonded polyester thread is used in the stitching.

The weather cover is water repellant but not water proof. During a hard rain, you may notice a light mist permeating through a weather cover. This is normal. If the seams leak, they can be sprayed with Scotchguard™ or similar water repellent or a seam sealing compound can be applied. Keep objects from contacting the inside of the cover. Leakage may occur at point of contact.

Weather covers must be installed taut or will be damaged by accumulation of rain water.

NOTICE

Periodically check weather covers for accumulation of water. Damage to the bow assemblies may otherwise result. Make sure cover is taut to avoid puddling of water.

After use, the top canvas should be rolled up into the boot (if supplied) and secured.

NOTICE

NEVER fold or store a wet weather cover. This can lead to mildew or shrinkage. Roll rather than fold the enclosure curtains. Sharp folds increase the chance of cracking the clear vinyl.

NOTICE

DO NOT use the weather covers during outdoor winter storage. The weight of the snow or heavy rain can cause severe damage to the material or top structure. Refer to O-3 Winter Storage in this manual for more information.

When snapping covers to the boat, apply direct downward pressure on the snap. When unsnapping, rotate the snap and cover upward at each snap location.

NOTICE

Remove snaps one at a time to prevent damage. DO NOT rip off or pull the weather cover as a whole; acrylic material may tear at snaps.

A. Bimini/Camper Top

A bimini/camper top is standard on all the Candia FS models. This style is a “freestanding” top and supported only by the bow assembly. Refer to Figure O1.

To install:

1. Attach the bimini main bow to the windshield mount on the 234/254 or the deck mount on the 214. The secondary bows should be loose to allow for adjustment.
2. Attach the forward nylon straps to the strap eyes located on the deck.

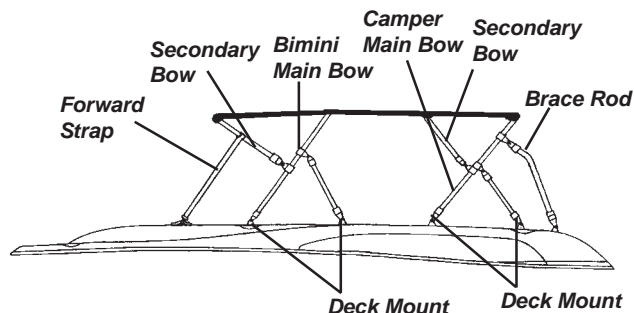

Figure O1: 214 CFS Bimini/Camper Top

3. Attach the camper main bow to the deck mount.
4. Attach the brace rod to the angled stern deck mount.
5. Adjust the secondary bows and straps for tautness.

You may choose to run your Candia FS with the bimini top either fully deployed or folded together (closed) and secured with the boots provided. Either way it is designed to remain mounted. No storage is provided for this top in your boat.

NOTICE

If you desire to remove the bimini top (winter storage), use two people. This will help minimize the risk of injury and help prevent damage to the upholstery, the bimini top, and/or the boat.

NOTICE

The bimini/camper is a single unit. It can not be used with any other piece of canvas.

B. Forward Cover

The forward cover is available on 234 and 254 Candia FS models. It is installed over the bow seating area and is snapped to the deck and to the cockpit cover at the walk-through. An adjustable pole is provided to adjust the canvas for tautness. Refer to Figure O1.

C. Cockpit Cover

The cockpit cover is used to cover the complete cockpit area and is intended as a short term storage cover. The cockpit cover is only available for the 234 and 254 Candia FS.

To install:

1. Snap the forward edge of the cockpit cover to the walk-through on the windshield. Windshield snaps will slide to adjust to the canvas.
2. Secure the rear corners.
 - a. If the canvas has snaps along the aft edge, secure the corners.
 - b. If the canvas has shock cords along the aft edge, attach to knobs as shown in Figure O2.

3. Snap the cockpit cover sides and rear (if applicable) to the deck.

An adjustable pole is provided to adjust the canvas for tautness.

D. Mooring Cover

Mooring covers, available for all the Candia FS models, are intended for longer term storage and spread over the entire boat. If used in areas with snow accumulation, be sure to support the canvas adequately and inspect frequently for snow loads or damage will occur. Refer to O-3 Winter Storage for additional information.

To install:

1. Spread mooring cover over entire boat.
2. Install adjustable poles in bow area (if applicable) and in the rear cockpit. Be sure the canvas is taut and no pockets exist.
3. Tie off at the transom.
4. Nylon loops are provided for attaching rope or bungee cords to the trailer or from side to side (under the boat).

O - 2 TRAILERING

High winds encountered during trailering your boat can severely damage most weather covers. If an extended trip at highway speeds is planned, the top and other weather covers should be in the down position or removed entirely. This will prevent damage and loss.

NOTICE

DO NOT tow your boat at highway speeds with weather covers in place. High winds encountered during trailering your boat can severely damage most weather covers. Damage to weather covers incurred as a result of trailering your boat is not covered under warranty.

O - 3 WINTER STORAGE

The boat must be properly protected during winter dry dock storage. A winter storage cover is advisable. Many marine dealers offer shrinkwrap enclosures for outdoor storage. See a Four Winns® dealer for information on the availability of winter storage covers or other alternatives for storage.

When storing outdoors, make sure the supporting framework keeps the weight of the snow and rain from accumulating on the storage cover. Proper ventilation must also be provided or dry rot and mildew will occur. See Section R General Maintenance for additional winter storage information.

O - 4 MAINTENANCE

Moisture, dirt, chemicals from industrial fallout, heat, ultraviolet rays and in some cases, salt water are factors which affect the longevity of acrylic covers.

1. Moisture can cause shrinkage and mildew. Allow the cover to dry thoroughly before disassembling tops. Keep it clean and well ventilated to prevent mildew. Spraying the weather cover with Lysol Disinfectant™ or similar product will help prevent mildew.
2. Dirt creates a starting point for mildew when moisture is present. Clean the top with a sponge or soft scrub brush and mild detergent when the cover is installed. Make sure cover is taut to help prevent shrinkage.
3. Chemicals cause decay if allowed to accumulate for long periods of time. Keep the cover clean to prevent decay.
4. Heat can cause cracks in vinyl components and stiffening of fabric when enclosed in plastic or polyethylene. DO NOT store the weather cover in polyethylene under direct sunlight or high temperature situations.
5. Ultraviolet degradation may occur under prolonged exposure to direct sunlight. Store the top in the boot when not in use.
6. Salt water can corrode brass, aluminum, or stainless steel fittings and fasteners. Keep fittings clean, lubricated, and waxed to prevent corrosion.

Clear vinyl curtains and windows demand extra care to prevent scratching. DO NOT use cloth or chamois skin. Dirt or grit in the cloth will scratch the vinyl window. Hose clean water onto vinyl to rinse off salt, dirt, or grime.

NOTICE

DO NOT use hot water. DO NOT dry in an automatic dryer. DO NOT dry clean or steam press.

Leakage after cleaning may be the result of insufficient rinsing. Re-rinse. If leakage continues, apply a coat of silicone air drying water repellent, such as Scotchguard™. See your Four Winns® dealer for additional information on weather covers.

O - 5 CARBON MONOXIDE

When the boat is underway, a natural vacuum may exist with the right wind and sea conditions to draw the exhaust gases (which includes carbon monoxide) into the boat. When the side curtains are installed, this compounds the possibility of this occurring. Carbon monoxide may also be present when mooring or near sea walls. For more information, refer to Section B-2 Carbon Monoxide in this manual.

The carbon monoxide in exhaust fumes can be hazardous. It is important for you and your passengers to be aware of the potential safety hazard created by exhaust fumes. Familiarize yourself with the symptoms of individuals overcome by carbon monoxide, and most importantly, ways you can protect yourself and your guests.

WARNING

Exhaust fumes from engines contain carbon monoxide. Boats with canvas deployed are more likely to collect exhaust fumes. Avoid brain damage or death from carbon monoxide. Keep cockpit and cabin areas well ventilated. Signs of exposure include nausea, dizziness, and drowsiness. See Section B-2 of the boat owner's manual for more details. If using a catalytic heater, provide ventilation. Do not use catalytic heater while sleeping.

FIBERGLASS AND HULL INFORMATION

P - 1 HULL DESIGN INFORMATION

Four Winns® boats are designed using the sound engineering and mathematical principles of hydrostatics, hydrodynamics, structure, and strength of materials. The materials utilized provide optimum strength at the lightest possible weight. The exact fiberglass laminate schedule and construction techniques of each part is determined in accordance with the strength and rigidity required.

All Four Winns® include our patented **Stable-Vee™** hull design. Pods on either side of the outdrive extend the running surface beyond the transom. These pods, plus the unique distribution of deadrise from transom to bow, allows Four Winns® to place more hull in the water than deep-vee designs of similar length and beam. This results in better boat handling whether on plane, during turns, or at rest.

P - 2 FIBERGLASS CONSTRUCTION

The fiberglass components of Four Winns® boats are of the finest quality materials, workmanship and construction techniques available. This ensures the structural integrity to provide years of boating enjoyment with minimal maintenance.

The construction of a Four Winns® hull begins with the application of gel coat to the mold. The gel coat is approximately 25 mils thick. A coat of resin and chopped fiberglass is then sprayed into the hull and carefully hand rolled until it is securely affixed to the gel coat.

A number of fiberglass layers and woven roving are applied to the above laminate. Each layer is hand laid and hand rolled. The keel and chine areas have fiberglass woven roving overlapped in these areas to provide additional strength. Some models utilize encapsulated end-grain balsa core or coremat laminates to achieve additional rigidity. Others utilize additional laminations of woven roving to maintain strength and rigidity.

The hull support stringers are located using special tools, and are fiberglassed into place. This ensures a strong, rigid hull, permanently formed into a solid assembly, free of distortions.

Fiberglass cockpit liners and seat base are constructed similar to the hull. Balsa core or coremat laminations are utilized when necessary.

In addition to a thorough visual inspection of each fiberglass component, samples are measured using special equipment, for fiberglass reinforcement to resin ratio, laminate configuration, weight and thickness. By these procedures Four Winns® ensures proper composition.

P - 3 EQUIPMENT INSTALLATION

Many boats are used for specific purposes or under conditions which require the addition of special equipment to the hull or deck. Special care must be taken during the installation of any equipment to a fiberglass component. A polysulfide or butyl based sealant should be used to seal installations below the water line. Silicone "marine" seal or similar bedding compound should be used elsewhere.

NOTICE

DO NOT install any item onto or through the hull without adequately sealing the hull area penetrated by the installed item or related fasteners. Improper installations could cause leakage or allow water absorption and thus cause serious hull damage.

Always predrill fastening holes with a proper size bit. Predrilling will help prevent the fiberglass from splintering and thus causing unsightly damage. Also, countersink holes to prevent the gel coat from chipping.

Any equipment which will be subjected to cyclic loading or significant force should be through-bolted to a fiberglass component. A butt block or backing plate should be used to strengthen any area onto which an item will be mounted.

P - 4 FIBERGLASS CARE & MAINTENANCE

Fiberglass is affected by weathering processes and requires maintenance on a periodic basis to help maintain the beauty and shine. The effects upon the gel coat will be dependent upon boating conditions, storage, type of use, and the care given to the boat during the boating season.

Four Winns® utilizes fade-fighting Armorcoat™ gel coat in the exterior finish. It is specially formulated to resist fading and yellowing, and retain more of its original gloss than better grade gel coats. However, it is still important to maintain the gel coat to protect the finish.

A. General Maintenance

For fresh water use, the boat should be washed once or twice a month. When using in a salt water environment, considerable more care will be necessary. Be careful when selecting a cleaning agent. Hand dishwashing detergents are usually gentle and are recommended for cleaning gel coat. Cleaning products such as Ivory or Dawn hand dishwashing liquid can be safely used. Always read the label before using any product.

NOTICE

DO NOT use acetone, paint thinner, solvents, or strong alkaline based detergents, nor cleaners with a “gritty” and abrasive texture. Avoid products which contain sodium phosphate. Common examples of these types of household cleaning agents are: Tide™, Oxydol™, Janitor-in-a-Drum™, Fantastik™, Clorox™, etc. Always read the label before using an agent.

There are several products available which are specifically designed to clean fiberglass exterior finishes. Many companies like Johnson & Johnson®, Turtle Wax®, etc. manufacture cleaning fluids mild enough to clean without stripping the wax.

NOTICE

Treading on a soiled fiberglass surface can severely scratch and mar the finish. Keep the fiberglass as clean as possible.

When cleaning nonskid areas, DO NOT attempt to use a wire brush or sandpaper because this will remove the nonskid gel.

Apply wax once a month to maintain gel coat lustre. Read the label before using any product. Make sure product is applicable to fiberglass. Refer to the brochure on gel coat care in your owner’s packet. Also, consult a Four Winns® dealer for his recommendations.

NOTICE

Do not use carnuba based waxes. This type of wax yellows over time and makes the fiberglass appear yellow.

 **CAUTION**

Waxing decks, cockpit floors or other areas on which one walks is not recommended. Waxing will produce a very slippery surface, especially when wet. Wax may also buildup in the nonskid surfaces. Be sure all persons wear deck shoes while aboard the boat. Footing will be improved and feet will be protected from accidental cuts and bruises.

A darkening or discoloration of the nonskid surfaces can sometimes occur as a result of wax buildup. Exposure to the sun and elements can turn the wax darker, or occasionally can cause it to become flaky or powdery. To remove, use fine rubbing compound and a low RPM buffer (1200 to 2000 RPM). Apply light pressure and keep the buffer moving at all times to prevent heat build up. Read the directions before using any equipment.

B. Weathering Effects on Gel Coat

Weathering occurs from direct sunlight, water, chemicals, and dust. Some of the terms below describe the changes that can occur to the gel coat surface.

Chalking is a result of the gel coat’s top surface being broken down into an extremely fine powder. When this happens, the color whitens. The chalk is present on the surface only.

Fading is the uniform change in color. This happens when the actual pigments have changed color, especially from excessive chalking, or when the gel coat has either been stained or bleached by something.

Yellowing is gel coat which has a yellow cast and streaking usually deals with a stain or contact with another surface.

Gloss refers to the shine of the surface. This can change from sanding action, chalk, residues, or exposure.

Blistering refers to a condition in which the unprotected gel coat surface below the waterline has absorbed water and formed bubbles. See Section P-5 for additional information.

Follow the instructions below for boats that have weathered and chalked.

1. Wash.
2. Wax. If this does not work, then use a fine rubbing compound. If this does not work use 400 or 600 wet or dry sandpaper, followed by fine rubbing compound and wax.

When using wax or fine rubbing compounds, make sure to read the label and follow the directions. Some helpful tips are listed below.

1. Avoid working in direct sunlight. This dries out the wax or compound, and can stain the surface.
2. Use clean pads or cloths to apply a thin coating of wax or rubbing compound to a small area such as three feet by three feet. Remove any excess, and then rub the area with a buffing pad, or power buffer. Apply pressure only as necessary to restore the surface finish. Applying too much pressure or buffing in one place too long can permanently damage the surface.
3. After applying compound, always follow with waxing.

NOTICE

If using a power buffer, use a low RPM buffer with light pressure. Keep the pad wet and the buffer moving at all times to prevent heat build up.

NOTICE

When sanding, DO NOT use a power or belt sander to prevent gouges, uneven areas, or other damage. For best results, block sand the gel coat.

C. Stains

Stains can appear anywhere on the exterior of the boat and may be a result of contact with tar, plant sap, leaves, rust from metal fittings, and other materials. Surface stains may be removed with hand dishwashing soap, mild cleansers, or some household detergents. DO NOT use chlorine or ammonia products. These products can affect the color of gel coat. Commercial car washes use strong cleaners and should be avoided.

To remove stains, refer to the procedures below.

1. Wash area with hand dishwashing soap.
2. Begin with a small area such as three feet by three feet and apply a mild cleanser.
3. Rinse with clean water.
4. Follow with compound and waxing as outlined in procedure above.

If the stain is not removed by the hand dishwashing soap or mild cleanser, then the next procedure is to use either denatured or rubbing alcohol. If this does not work, consult your Four Winns® dealer for professional assistance.

NOTICE

DO NOT use acetone, ketone, or other solvents to remove stains. These chemicals are flammable and may damage the gel coat.

P - 5 FIBERGLASS REPAIRS

Fiberglass is one of the most durable, strong, and forgiving construction materials afloat. It is resilient and normal repairs can be made without affecting the strength or structural integrity of the boat.



WARNING

Striking docks, other boats, or submerged objects could create a very hazardous situation or severely damage the fiberglass. In the event an object is struck below or near the waterline, proceed directly and cautiously to the nearest service facility and remove the boat from the water. Closely inspect the hull for damage. If the outer fiberglass laminate was penetrated, repairs must be made prior to relaunch.

Occasionally, blisters, crazing, scratches, or damage to the fiberglass can occur. Repairs may be necessary to correct the problem.

A. Scratches

Scratches occur during normal use. Below is a step by step procedure to repair scratches.

1. Clean area with soap and water.
2. Apply a fine rubbing compound and buff.
3. Wax.

If this does not work, clean the area and sand lightly with 400 to 600 wet or dry sandpaper and follow with rubbing compound and wax.

B. Gouges & Cracks

Stress cracks and crazing are the appearance of hairline cracks in the gel coat surface. When present, these problems usually occur in the gel coat finish or the outer "skin coat" fiberglass laminate. The appearance of these cracks does not pose a threat to the structural integrity of the boat. In most cases, they are cosmetic and can be treated.

Cosmetic surface damage can be repaired as follows:

1. Sand the surrounding area with medium or fine grit sandpaper. Clean all marine growth, dirt, antifouling paint, etc. from the immediate area. **DO NOT** excessively scratch or gouge the surrounding area.
2. Use a hard, pointed tool to open the gel crack. Take care not to damage the surrounding gel coat.

3. Sand the crack or gouge so the edges are smooth and will allow proper "feathering" of the area.
4. Clean the area thoroughly. Make sure the area is dry before proceeding.

NOTICE

Be sure the structure and the ambient temperature are above 60 degrees F (15 degrees C) and the relative humidity below 70% immediately before, during, and after the repair.

5. If the nick or gouge is deep and penetrates through the gel coat, fill the area with fiberglass patching paste. Follow the directions on the can when mixing the paste with the catalyst.
6. After the gouge is filled and has dried, sand the patched area. Begin by using medium-fine grade sandpaper. Progressively use finer grade sandpaper until the surface is very smooth. If necessary, add filler and then sand the surface again.
7. Apply two or three light coats of matching fiberglass gel coat to the repaired area. Enough gel coat should be used so that the entire area is covered.

The gel coat must be catalyzed using up to 2% MEK Peroxide which can be purchased at a supplier handling fiberglass reinforced products. Contact your Four Winns® dealer for assistance.

8. After ample drying time, sand the area using very fine wet/dry sandpaper. If the appearance of the area is still not satisfactory, repeat steps 2 through 8 as necessary.
9. If above the waterline, polish the area using a fiberglass rubbing compound and then wax. If the repaired area is below the waterline, the area should be primed and painted in accordance with the anti-fouling paint manufacturer's instructions.

Gel coat, like paint, will change colors with time and exposure to sunlight (ultraviolet). For this reason, "matching" gel coat obtained from Four Winns® may not match the gel color of a boat that has been exposed. However, this is the closest match commercially available. A fiberglass technician can tint the gel to be used in the repair to provide a closer color match.

More severe fiberglass damage, especially when structural, requires the expertise of an experienced fiberglass repair technician. See your Four Winns® dealer for assistance.

NOTICE

Improper repair techniques can lead to further fiberglass component damage.

C. Osmotic Blistering

Osmotic blistering or “boat pox” is an unfortunate but not uncommon occurrence in fiberglass boats. Fiberglass is water retardant, not waterproof. When a boat is left in the water for a period of time, the fiberglass will absorb water. It is a natural process that can not be eliminated in production methods or material selection and usage. However, there are ways to control and possibly prevent blisters (see Section P-6). If you do encounter blisters, be assured that the blisters are merely cosmetic. They do not indicate a defect in the boat structure or lamination. Four Winns®, along with most boat manufacturers, regard gel blisters as a standard maintenance item.

The repair procedure for gel coat blisters is similar to the procedures outlined in the previous section on cracks and gouges. There is an exception however, in that the hull must dry out for several days or possibly weeks before repairs can proceed.

To determine if the hull has dried sufficiently, tape one square foot of household plastic wrap securely to the hull bottom. Make sure all edges are sealed and let it stand for twenty-four hours. If condensation has accumulated under the plastic, the hull is still “wet” and must be allowed to dry longer before repairing.

When the repair is completed, an application of an epoxy barrier coat should be considered. This will help prevent the possibility of reoccurrence of blisters. Your Four Winns® dealer or local ship store will have information on barrier coat products.

P - 6 ANTIFOULING PAINT

Four Winns® recommends antifouling or bottom paint for boats which will be kept in the water for extended periods of time. Antifouling paint reacts with water to retard the growth of algae, barnacles and other marine growth on the hull. In addition to marine growth, it offers protection against excessive water pollution.

Antifouling paint begins reaction upon contact with water. After a season’s use or sooner under certain conditions, the antifouling paint may appear to be dissolving. This is due to the paint’s chemical emission that in turn retards marine growth. When this occurs, refinishing is in order.

Four Winns® recommends reapplication of the antifouling paint seasonally. The effectiveness of the paint will be drastically reduced if used longer. Though Four Winns® has found the antifouling paints used to provide good marine growth protection in most water, other paints may be more effective in certain water conditions. See a Four Winns® dealer for recommendations on antifouling paint use in your area.

NOTICE

During surface preparation, the hull should be sanded only enough to remove any foreign matter, and loose paint. DO NOT sand deeply into the gel coat, fiberglass cosmetic problems could later result. After sanding, the surface should be wiped with a rag treated with a cleaner recommended by the antifouling paint manufacturer. The surface must be clean and slightly rough to ensure paint adhesion.

Prior to application of the antifouling paint, the boat owner may consider coating the hull bottom with an epoxy coating. Four Winns® recommends this procedure as a preventive and effective means of controlling osmotic blistering. Most major antifouling paint manufacturers also supply a line of epoxy undercoatings. Consult your Four Winns® dealer for recommendations on epoxy undercoatings.

P - 7 HULL SUPPORT

Proper support of the hull while it is out of the water is imperative. Due to the design complexities, Four Winns® does not recommend trailers or storage cradles be homemade. The boat is a valuable piece of equipment. DO NOT risk permanent damage to the hull structure in an attempt to save the cost of an adequate support. Improper support can lead to serious and permanent hull deformation.

 **CAUTION**

Failure to adequately support the hull may result in permanent hull structure damage and will invalidate the hull structure warranty.

NOTICE

When attempting to raise the hull, never allow one end of the boat to rise first, while letting the opposite rest momentarily on the outdrives or underwater gear. Serious damage to these components could result. **DO NOT** place lifting straps on underwater gear. Be sure the strap is against the hull surface only.

A trailer, or storage cradle designed for a larger or smaller boat will not provide proper support for the hull. This could lead to hull deformation and thus serious performance deficiencies.

Four Winns® trailers are available for all Candia FS models. Refer to Section S - Trailers for additional information.

WOODWORK AND COMPOSITES

Q - 1 HIGH-PRESSURE LAMINATE CARE

Table tops consist of a high pressure laminate, “formica” like material. The formica has a “matte texture” finish and can be cleaned with hand dishwashing soap and water or other cleaning solutions such as Fantastik™. Always read the label before using any product.

NOTICE

DO NOT use abrasive cleaners or solvents on formica. DO NOT use Soft Scrub™ soap or similar cleaning products; they will scratch the surface and remove the shine.

Q - 2 STAR BOARD

Star board is a high density polyethylene (plastic) and is very durable and fade resistant. Star board requires little maintenance, and is being used in place of wood in many areas of the boat. It is currently being used for ski rack facers, ski locker lids, and seat supports.

To clean star board, use a solvent-free, nonabrasive cleaner such as hand dishwashing soap or Fantastik™. Read the label before using any cleaning product.

NOTICE

Star board will stain when exposed to certain oils or chemicals. Always wipe up any spills immediately.

Q - 3 CHERRY ENHANCEMENTS

Cherry enhancements are standard on Candia FS models. They consist of a finished synthetic cherry. This cherry is found in the instrument panel of the 214 CFS (I/O and O/B). The 234/254 Funships also have a cherry trim ring framing the VDO instrument module. In addition, the ignition switch panels and the emergency switch panels, consist of this cherry.

To clean, a damp cloth will usually suffice.

GENERAL MAINTENANCE

R - 1 WINTERIZATION

A. Prior to Lifting for Winter Layup

1. Pump out the head (dockside discharge if applicable), and be sure the holding tank is empty. Flush the head holding tank with soap, water and a deodorizer (e.g., Lysol Liquid™). Add more water if necessary. Have the cleaning solution pumped out.
2. Have the fuel tank either full or completely empty. See the Engine Owner's manual for recommendations. Also, check with the dry dock operators for recommendations. If winter storing with a full fuel tank, gasoline winterizer such as Sta-bil® Fuel Conditioner will reduce varnishing, condensation, etc.

NOTICE

If the fuel has been treated with winterizer, run engines for ten minutes to make sure the treated fuel is present in all lines and parts of the engine.

3. Drain water from the fresh water system (if applicable).
4. Winterize the engine and drive systems as recommended in the Engine Owner's manual. Portions of this winterization procedure may require that the boat be lifted.
5. If the boat is to be lifted or taken off the trailer, see Section P-7 Hull Support in this manual for additional details.

B. After Lifting

1. Remove the drain plug.
2. Thoroughly wash the fiberglass exterior, especially the hull bottom. Remove as much marine growth as possible.
3. Lower boat onto cradle properly or place boat on trailer. Be sure boat is adequately supported. The boat should be raised slightly under the forward supports or trailer tongue to improve drainage to the transom drain.

4. Be sure all the water is completely drained from the fresh water system. Disconnect all hoses, check valves, etc. and blow all the water from the system using very low air pressure. The use of nontoxic, fresh water system antifreeze is recommended as an alternative to disassembling the water system. Refer to Section J-5 System Maintenance in this manual for information on winterizing the water system.
5. Winterize the head as recommended by the head manufacturer. If the boat is equipped with a holding tank, mix some antifreeze solution and pour it into the head. Transfer some of the antifreeze to the holding tank by flushing the head. Also, refer to Section J-5 System Maintenance for additional information.
6. Ensure that all water is removed from the bilge pump and bilge pump lines. Dry the hull bilge, and self-bailing cockpit drain troughs. Water freezing in these areas could cause damage. See Section K-2 Hull Drainage Systems.
7. Remove the battery(s) and store in a cool place. Clean the batteries using clear, clean water. Be sure the battery has sufficient water and clean terminals. Keep the battery(s) charged throughout the storage period. DO NOT store the battery(s) on a concrete floor or other damp or conductive surface.
8. Remove the butane canister from the stove (if applicable) and store in a cool, dry place away from heat or spark.
9. Clean the boat interior thoroughly. Vacuum carpets, and dry clean drapes and upholstery jackets as necessary.
10. Scrub the hull bottom and wash exterior fiberglass components, wax lightly.
11. Clean exterior upholstery with mild soap and water. Rinse and dry thoroughly.
12. Remove all oxidation from exterior hardware and apply a light film of moisture - displacing lubricant.

C. Prior to Winter Storage

1. Remove as many cushions as possible. Remove storage lids or hatches. Open as many locker doors, as possible. Leave these areas open to improve ventilation.
2. Spray the weather covers and the boat upholstery with Lysol Spray Disinfectant™. Enclosed areas such as storage locker areas should also be sprayed with Lysol Disinfectant™.
3. Place small dishes of rodent poison such as D-Con™ in a number of areas around the boat. Be sure dishes are placed near the head and the engines, as rodents will destroy upholstery, water intake and discharge hoses.
4. If the boat will be in outside storage, properly support a storage cover and secure it over the boat. DO NOT secure the cover tightly to the boat. This does not allow adequate ventilation and can lead to dry rot. DO NOT store the boat in a damp storage enclosure. Excessive dampness can cause electrical problems, corrosion, and dry rot.
5. DO NOT use the bimini top or camper top as a winter storage cover. The life of these covers may be significantly shortened if exposed to harsh weather elements for long periods.

 **WARNING**

Placing an electric or fuel burning heating unit in the bilge of the boat during cold weather could cause fire or explosion and is not recommended.

NOTICE

Boats stored outside in areas with heavy snow accumulation are more susceptible to damage, and should be inspected regularly during the winter months

6. **Engine should be winterized according to the engine manufacturers manual.**

R - 2 ENGINE FLUSH OUT

The optional engine flush out should be used to clean the engine of unwanted salt, mud, sludge, etc. which may have accumulated in the engine cooling system. Before winterizing the engine, flush out the system for at least five minutes.

 **CAUTION**

Make sure that no section of flush hoses are in contact with moving or hot engine parts or abrasive surfaces such as screw threads, sharp edges, etc., which could damage the hoses. Damage to the hoses could cause leaks and possible flooding of the engine compartment. Periodically check hoses for abrasions.

NOTICE

The flush out kit should only be used with the boat in the water and the engine OFF.

To flush out the engine, follow the instructions below.

1. **Do not run engine during flushing procedure.**
2. Remove cap from coupling and attach swivel connector.
3. Attach water supply hose to swivel connector.
4. Turn water on and allow water to flush the engine and exhaust manifold for five to ten minutes.
5. Turn water off. Disconnect hose; replace and tighten cap securely.

 **CAUTION**

Reinstall cap onto coupler after flushing. Flooding of the engine compartment will occur if the cap is not installed and tightened.

R - 3 GENERAL MAINTENANCE SCHEDULE

SERVICE	AT LAUNCH AND FIRST OPERATION*	25 HOUR CHECK EACH SEASON*	BI-SEASONALLY OR EVERY 6 MONTHS OR EVERY 100 HOURS*	SEASONALLY OR EVERY 12 MONTHS OR EVERY 200 HOURS*
Engine and Instrumentation	Refer to Section E			
Engine Maintenance	As Recommended by the Manufacturer			
Inspect Exhaust System Hoses and Connections				
Check Propellers				
Check All Thru-Hull Fittings				
Test Emergency Shut-Off Switch				
Gauge Cleaning				
Controls Systems	Refer to Section F			
Throttle and Shift Adjustment				
Neutral Safety Switch Test				
Cable and Control Lubrication				
Steering Systems	Refer to Section G			
Linkage and Connection Inspection				
Stern Drive Torque Tab Adjustment				
Power Steering Service	As Recommended by the Manufacturer			
Steering Adjustments				
Steering System Lubrication				
Electrical Systems	Refer to Section H			
Inspect Battery Connections				
Check Battery Water				
Battery Cable Inspection				
12 Volt Electrical Equipment Operation				
12 Volt Wiring and Connection Inspection				
Fuel System	Refer to Section I			
Inspect for Leaks				
Fuel Sender Inspection				
Fuel Filter Inspection				
Fuel Tank Inspection				

* Or as Required

 — Shaded areas indicate the time frame when service/inspection should be conducted.

SERVICE	AT LAUNCH AND FIRST OPERATION*	25 HOUR CHECK EACH SEASON*	BI-SEASONAL- LY OR EVERY 6 MONTHS OR EVERY 100 HOURS*	SEASONALLY OR EVERY 12 MONTHS OR EVERY 200 HOURS*
Water Systems	Refer to Section J			
Inspect All Water Systems				
Fresh Water Tank Inspection				
Drain & Flush Fresh Water System				
Ventilation and Drainage	Refer to Section K			
Blower Operation				
Blower Vent System Cleaning				
Bilge Pump Operation and Cleaning				
Check Transom Drain Plug				
Deck Hatch & Porthole Operation				
Interior Equipment	Refer to Section L			
Head Maintenance	As Recommended by the Manufacturer			
Thru-Hull Fitting Inspection				
Clean Cooler				
Stereo Head Cleaning and Demagnetizing				
Exterior Equipment	Refer to Section M			
Check PFD's for Serviceability and Correct Number	As Required			
Check Charge of Fire Extinguishers	As Required			
Check Compass for Magnetic Deviation				
Check Trim Tab Fluid Level				
Check Trim Tab System for leakage				
Upholstery	Refer to Section N			
Clean Upholstery				
Clean Carpet				
Spray Upholstery with Lysol				
Check Seat Hinges and Mounting Hardware				

* Or as Required

— Shaded areas indicate the time frame when service/inspection should be conducted.

SERVICE	AT LAUNCH AND FIRST OPERATION*	25 HOUR CHECK EACH SEASON*	BI-SEASONALLY OR EVERY 6 MONTHS OR EVERY 100 HOURS*	SEASONALLY OR EVERY 12 MONTHS OR EVERY 200 HOURS*
Weather Covers	Refer to Section O			
Wash Weather Covers				
Spray Weather Covers with Lysol				
Fiberglass Components and Hull	Refer to Section P			
Check All Fastenings (securing rails, seats, etc.)				
Clean Fiberglass Thoroughly				
Wax Hull Sides and All Non-Tread Areas				
Inspect Fiberglass Areas for Damage				
Perform Minor Touch-Up Repairs				
Sand Hull and Re-Apply Anti-Fouling Paint				
Woodwork & Composite Maintenance	Refer to Section Q			
Clean Star Board	As Needed			
Clean Cockpit Tables	As Needed			
Trailers	Refer to Section S			
Wax Trailer				
Lubricate Trailer Jack				
Lubricate Trailer Coupler				
Lubricate Trailer Winch				
Brake Operation	Before Every Use			
Brake Inspection				
Inspect Hubs/Disc Brakes				
Inspect Bearings & Seals				
Lubricate Bearings				
Springs, Hangers & Suspension Parts				
Wheel Lug Nut				
Wheels				
Tire Pressure & Condition	Before Every Use			

* Or as Required

— Shaded areas indicate the time frame when service/inspection should be conducted.

TRAILER INFORMATION

S - 1 GENERAL TRAILER INFORMATION

The trailer must properly “match” the boat’s weight and hull design. Four Winns® trailers are designed specifically for each boat model. Four Winns® trailers meet or exceed the National Marine Manufacturers Association’s trailer requirements.

Four Winns® manufactures bunk type trailers. The bunks are located specifically for Four Winns® boats and adequately support all parts of the boat. It is a “drive-on” type trailer which means winching the boat from the water is not necessary.

NOTICE

When winching the boat onto the trailer, **be sure the bunks are wet to prevent damage to the boat or trailer.** DO NOT attempt to winch the boat forward when out of the water. Damage to the winch stand/assembly or tongue could occur.

Four Winns® offers both painted and galvanized trailers. The painted trailer is intended to be used in fresh water and the galvanized trailer in salt/brackish water.

NOTICE

Four Winns® does not recommend the usage of painted trailers for salt/brackish water conditions, as trailer life may be substantially reduced.

A. Regulations

Federal law requires that the trailer and tire registration information be compiled and recorded. The Four Winns® boat registration card includes trailer registration information. A trailer tire warranty card included in the owner’s packet, is to be filled out and returned to the tire manufacturer.

NOTICE

The warranty of the tire is administered by the manufacturer of the tire. The manufacturer of the tires on your trailer is Carlisle Tire®. Please call 1-800-260-7959 regarding any warranty concerns relating to your tires.

Laws covering such items as trailer brakes, lights, safety chains, etc., will vary from state to state. Please contact the motor vehicle department in your state for additional information.

B. Load Carrying Capacity

The certification label shows the maximum load-carrying capacity and is located on the port forward side of the trailer. The Gross Vehicle Weight Rating (GVWR) is the load-carrying capacity plus the weight of the trailer itself. DO NOT exceed the GVWR rating for the trailer.

NOTICE

When using or choosing a tow vehicle with the correct GVWR, you must consider not only the weight of the boat and trailer but also the weight of the fuel, water, equipment, etc. Refer to Table 1 below:

EQUIPMENT	WEIGHT (AVERAGE)
Battery	50 Lbs.
Fuel	6.5 Lbs./Gal.
Water	8 Lbs./Gal.
Accessories	150 Lbs. (Approximate)

Table 1: Average Equipment Weight

If selecting a trailer from another manufacturer, check the load-carrying capacity. A trailer with a load-carrying capacity that is too low will be unsafe on the highway and could cause sudden failure of critical trailer components or abnormal tire wear. A trailer with too high of a load-carrying capacity that is sprung for heavy loads can damage a lighter boat.

NOTICE

DO NOT overload your trailer by placing camping gear or other heavy equipment in the boat. DO NOT exceed the GVWR rating. Damage to the hitch, coupler, or trailer may occur.

Improper weight distribution can place excessive strain on the towing vehicle and trailer. It can also cause the trailer to “fishtail” (sway side to side). Be sure gear and other items are distributed evenly in the boat.

C. Hitches

The load-carrying capacity of trailer hitches will vary between manufacturers and must equal or exceed the GVWR. Four Winns® trailers use surge disc brake systems and require a fixed hitch. Refer to Section S-2E Surge Disc Brakes for more information.

Before hitching the trailer to the vehicle, make sure the proper size hitch ball is installed to match the coupler. Please refer to the coupler or actuator on the trailer for ball size. Four Winns® 214 CFS IO & OB trailers require a 2" diameter hitch ball and a 2 5/16" diameter hitch ball is required for the 234/254 CFS trailers. Refer to Section S-3 Operation for additional information on hitches. Also, consult your Four Winns® dealer for his recommendation before purchasing a trailer hitch for your towing vehicle.

WARNING

To help guard against a sudden failure while in use, **do not use a worn hitch ball**. Replace all worn or damaged parts.

S - 2 TRAILER COMPONENTS

A. Bunk Supports

All bunk boards are made of pressure treated wood. This wood is rot resistant. All boards are covered with a high quality exterior grade carpet to protect the boat from damage during normal use.

Bunk supports run parallel to the keel and support the hull, extending beyond the transom. See Figure S1.

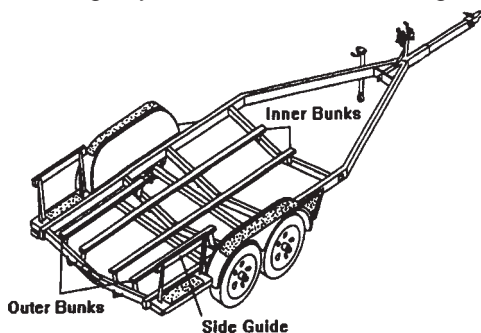

Figure S1: Trailer Bunks

Outer bunk supports provide stability for the boat. The inside bunks are the main weight bearing members. Side guide-on supports help to keep the boat straight while driving the boat onto the trailer. Keeping the tie-downs tightly fastened will prevent the boat from bouncing against the bunk supports.

NOTICE

Improper trailer setup can cause hull damage.

B. Tongue

Four Winns® trailers are designed with tongue weights between 5% and 10% of the total weight of the boat, fuel, gear and trailer. If the downward weight on the coupling ball does not fall within this range, coupler failure and towing instability may occur. If using another manufacturer’s trailer, have the dealer check the tongue weight before trailering.

NOTICE

DO NOT use a bent or damaged tongue or coupler. Replacement parts may be ordered through a Four Winns® dealer.

The trailer tongue is hinged on our painted trailers and removable on our galvanized trailers. This allows for easier storage. The tongue is attached with two clevis pins with locking hair pins to the trailer frame. Refer to Figure S2.

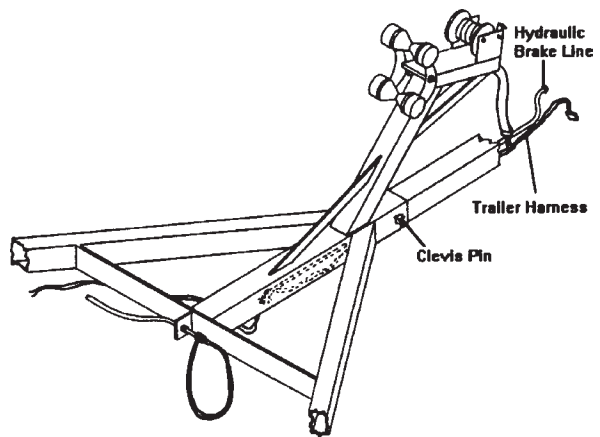

Figure S2: Trailer Tongue Assembly

To pivot the tongue on painted trailers for storage:

1. Make sure the trailer jack is supporting the trailer load properly. Refer to Section S-2C on Swivel Jacks for additional information.
2. Unplug the wire harness at the trailer cross member.
3. Disconnect the brake line coupler.
4. Remove the locking hair pins and clevis pins. Please note, the locking hair pins must be rotated away from clevis pin and then removed.

NOTICE

The tongue will exert some pressure on the clevis pins. It may be necessary to lift, push or wiggle the tongue to remove the clevis pins.

5. Slide trailer tongue out of receiver until the hinge is exposed. Pivot the tongue towards the trailer as far as it will go.

To reinstall, follow this procedure in reverse order.

1. Pivot the tongue so that it extends straight and is in alignment with the receiver.

NOTICE

When extending tongue ensure that the brake line and wire harness are not pinched. Failure to check could result in damage.

2. Slide the trailer tongue into the receiver until the clevis pin holes are aligned.
3. Insert clevis pins with washers and locking hair pins.

NOTICE

The tongue will exert some pressure on the clevis pins. It may be necessary to lift, push or wiggle the tongue to insert the clevis pins.

4. Reconnect the brake line coupler.
5. If towing the trailer, remember to plug the 5-wire tongue harness to the trunk connector wire harness of your tow vehicle.

 **CAUTION**

Make sure the trailer tongue is secure before hitching to the towing vehicle.

To remove the tongue on galvanized trailers:

1. Make sure the trailer jack is supporting the trailer load properly. Refer to Section S-2C on Swivel Jacks for additional information.
2. Unplug the wire harness at the trailer cross member.
3. Disconnect the brake line coupler.
4. Remove the ring cotters and clevis pins.

NOTICE

The tongue will exert some pressure on the clevis pins. It may be necessary to lift, push or wiggle the tongue to remove the clevis pin.

5. Slide trailer tongue out of receiver and store in a proper place. If the trailer has brakes, store the tongue upright to prevent brake fluid from leaking.

To reinstall, follow this procedure in reverse order.

 **CAUTION**

Make sure the trailer tongue is secure before hitching to the towing vehicle.

C. Swivel Jack

The jack is designed to lift, lower and support the tongues of the trailers when not connected to the towing vehicle. Before unhitching the trailer, use the following guidelines when setting up the jack.

1. Pull on the lock pin. See Figure S3.
2. Swivel jack to the vertical position.

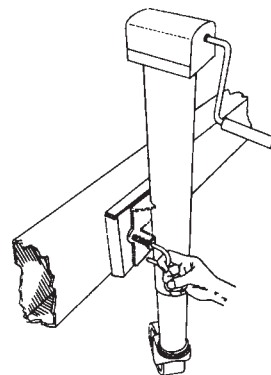

Figure S3: Swivel Jack

3. Release the lock pin and make sure the pin fully engages the attached tongue bracket.

CAUTION

Be sure dirt, sand, ice, etc., does not obstruct the proper seating of the lock pin.

4. When raising or lowering the jack, prevent the caster from rotating while cranking. Make sure the jack is planted on a firm and level surface before unhitching the trailer.

WARNING

To prevent personal injury or damage to the boat and trailer, observe the following:

- NEVER pull on the lock pin when any trailer weight is on the trailer jack.
- DO NOT move the trailer when resting on the swivel jack. Use towing vehicle to move the boat and trailer.
- Keep body and feet clear of trailer tongue when raising or lowering jack.

Always remember to swivel jack to the horizontal position before towing the trailer. Damage to the caster and jack may result.

The swivel jack provided on the Four Winns® trailer can be removed from the trailer to allow for maintenance or repairs. Follow the manufacturer's recommendations provided in the owner's packet.

D. Coupling Assembly

To unlock the coupler, pull the locking trigger upward with your index finger and lift the locking lever. To lock, push the locking lever down. See Figure S4.

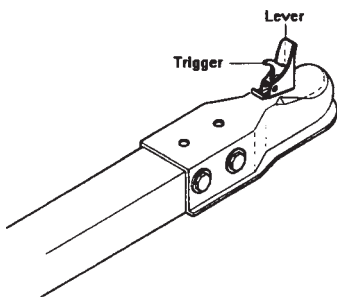

Figure S4: Coupling Assembly

This is also applicable to the Surge Disc Brake Actuator and Coupling Assembly.

E. Surge Disc Brakes

Surge disc brakes are available on 2000 model trailers manufactured by Four Winns®. Surge disc brakes operate automatically when the tow vehicle's brakes are applied. When the tow vehicle slows down or stops, the forward momentum or "surge" of the trailer against the hitch ball applies pressure to a master cylinder in the trailer coupler. The master cylinder supplies hydraulic pressure through the hydraulic system which activates the trailer's disc brakes. See Figures S5 and S6. Please refer to the manufacturer's literature included in your owner's packet for further details regarding operation and maintenance.

The benefits of disc brakes in comparison to drum brakes:

- Fewer moving parts.
- Longer life due to fewer moving parts.
- Friction pads are easily accessible.
- Easy access to caliper for cleaning and maintenance.
- Calipers are self-adjusting allowing smoother braking operation.
- Braking performance less likely to be affected by dirt, water, or rust contamination.
- Fade resistant.

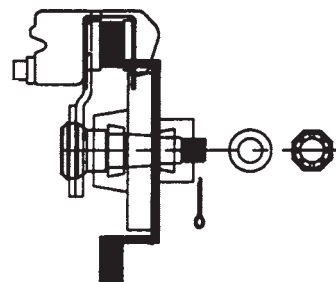
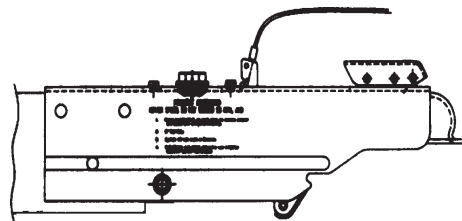

Figure S5: Brake Actuator & Coupling Assembly and Disc Brake

For boat models with the Surge Brake Actuator and Coupling Assembly shown in Figure S6, lift the release handle to unlock the coupler. Push down on the release handle/locking lever to lock the trailer to the ball hitch. The locking pin, provided with the trailer, or a padlock **must be inserted** in the locking lever hole. This ensures the the coupler's locking lever remains in the locked position during towing of the trailer. Refer to Section S-3 Operation for additional information on couplers and hitching to the tow vehicle.

NOTICE

Anti-sway devices as used on recreational vehicles (RV's) are not applicable to surge brake systems and should not be used on Four Winns® trailers.

DO NOT use a trailer hitch with moving parts. The brakes could activate when traveling downhill. Always use a fixed hitch.

If the brakes are wet from loading, travel at a slow speed and apply the brakes on your towing vehicle several times to “dry” out the trailer brakes.

Release handle must be in open position to remove from or place on ball.

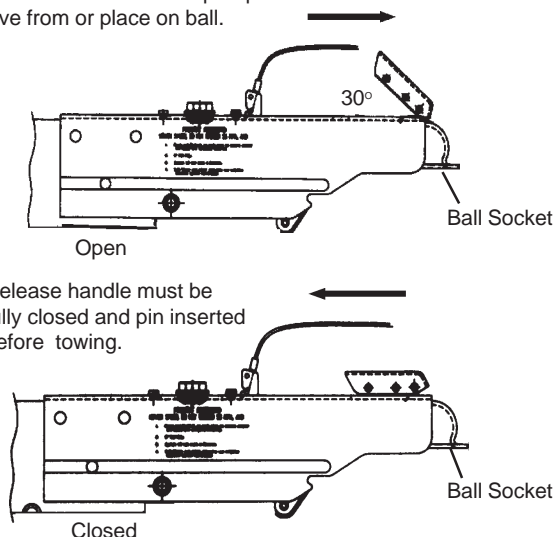

Figure S6: Surge Brake Actuator & Coupling Assembly

The 2000 models' trailer brake actuator and coupling assembly comes with a 5-wire plug for connecting to the tow vehicle's trailering harness. Figure S7 depicts the 5-wire plug, the color of the individual wires, and the designated circuit for each wire.

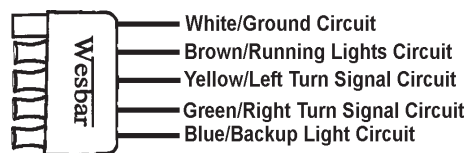

Figure S7: 5-Wire Plug Harness

For maintenance and other information, refer to the manufacturer's literature included with in the owner's packet.

F. Winch

Winch operating instructions are listed below.

To release the winch, place the ratchet in the REVERSE or NEUTRAL position. The winch handle may spin when pulling on the winch line.

CAUTION

To prevent personal injury, observe the following:

A spinning winch handle can cause injury. Be sure the area is clear.

DO NOT release the handle when the ratchet is disengaged. Be sure the ratchet is engaged or no load is on the winch before releasing the handle.

CAUTION

To prevent personal injury, ALWAYS inspect the winch line and hook before each use. NEVER use line that is worn or frayed. NEVER let anyone stand in or behind a boat while pulling with the winch.

To rewind the winch, ALWAYS engage the ratchet first. Turn the handle in the appropriate direction to rewind the line.

CAUTION

A clicking sound will be heard when the winch is properly engaged. If a clicking sound is not heard, DO NOT release the handle. Handle may spin backwards. Lower the load into a safe position before releasing the handle.

Refer to the manufacturer's literature, included in the owner's packet, for more information on winch operation.

G. Wheels

Trailer wheel rims are available in three types of finishes: white, aluminum and galvanized. The white, powder coat finish is standard. Aluminum rims (Mags) are optional on painted trailers. Galvanized trailers are equipped with matching galvanized rims. Spare tire covers are available as an option and will match the trailer.

The tires installed on Four Winns® trailers meet the trailer load requirements for each model. Before trailering, make sure the tires are inflated according to the manufacturer's recommendation. Tire pressure information is noted on the tire and in the manufacturer's literature included in the owner's packet.

Lug nuts must be checked for proper tightness after the first 50 miles and periodically thereafter. Lug nuts should be torqued to 85 foot pounds on white, galvanized, and aluminum wheels.

Mag wheels include a locking-type nut to help deter theft. This nut requires a special key or socket to remove. The socket will be included with your trailer when mag wheels are ordered. Refer to Figure S8.

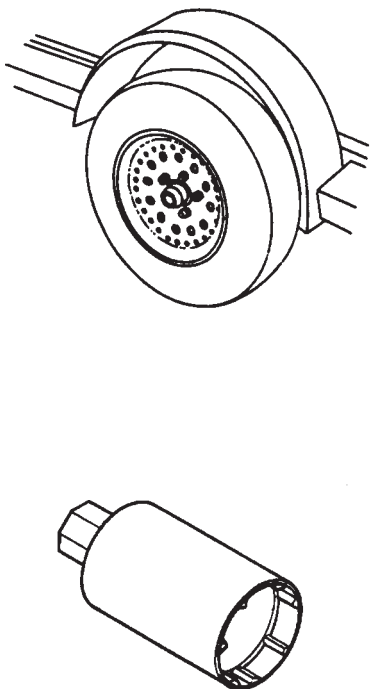

Figure S8: Mag Wheel & Mag Wheel Key (Socket)

NOTICE

DO NOT use an air wrench or other power equipment to install lug nuts on aluminum (Mag) wheels. Damage to the wheel may result. Lug nuts should be torqued to 85 foot pounds.

Examine the tires frequently for snags, bulges, excessive tread wear, separations or cuts.

Refer to the manufacturer's literature included in the owner's packet for more information.

NOTICE

The warranty of the tire is administered by the manufacturer of the tire. The manufacturer of the tires on your trailer is Carlisle Tire®. Please call 1-800-260-7959 regarding any warranty concerns relating to your tires.

H. Spare Tire Carrier

Spare tires are optional on all Four Winns® trailers. A spare tire carrier is bolted to the trailer frame and is available in painted or galvanized finish. A spare tire carrier and wheel can be ordered from your Four Winns® dealer. Refer to Figure S9.

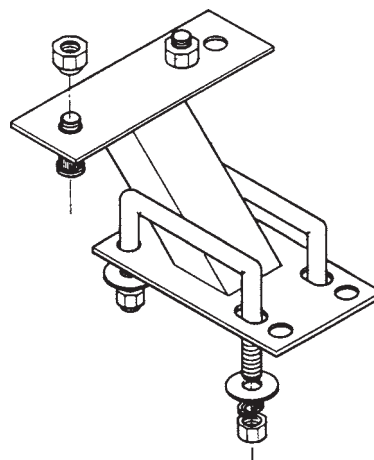

Figure S9: Spare Tire Carrier

I. Lights

Four Winns® trailers are equipped with taillights, brake lights, turning signals, and clearance lights. All lights are sealed to prevent moisture from entering. However, the taillight bulb assembly may be replaced. The bulb is assembled in a sealed housing and can be replaced. Contact your Four Winns® dealer for assistance.

NOTICE

Use a heavy duty turning signal flasher on towing vehicles. Check with your local auto parts store or ask your Four Winns® dealer for assistance.

Consult your dealer for state trailer regulations concerning lighting and other optional equipment.

J. Tie-downs

The boat should be secured to the trailer by tie-downs to prevent damage to the hull. The boat may shift or bounce against the bunks or hull supports if not secured. It may also slide or fall off the trailer while being towed.

There are two types of tie-downs being used:

1. **Bow Tie-downs:** A bow stop to hold the front of your boat in place is located on the winch stand. It should be positioned so that the winch line pulls straight and is parallel to the trailer frame. A separate tie-down should then be attached to hold the boat. See Figure S10.

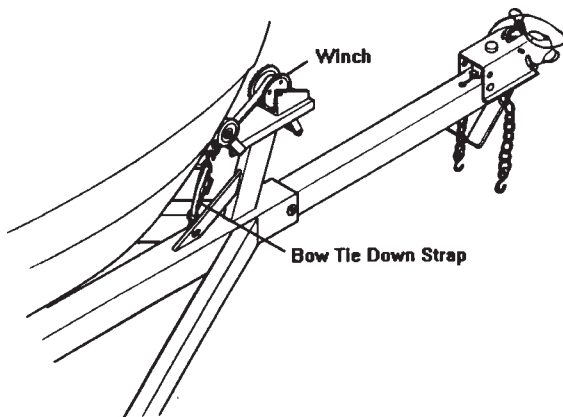
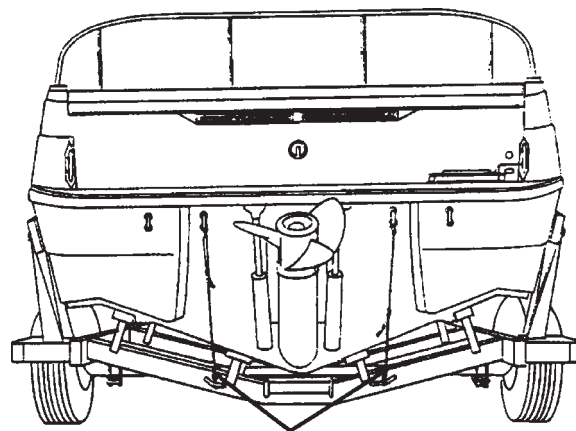

Figure S10: Bow Tie Down Strap

NOTICE

DO NOT rely on the winch cable (or line) alone to hold the bow of the boat against the bow stop. A bow tie-down is provided with the Four Winns® trailer.

2. **Rear Tie-downs:** It is very important that the transom is resting securely on the bunk supports at the rear of the trailer. Rear tie-downs are provided to secure the boat to the trailer. Tighten the tie-downs to prevent the boat from moving. See Figure S11.



Rear Tie Down Straps

Figure S11: Rear Tie Down Straps

The tie-down is a mechanical ratchet device. To allow line out, follow the procedures below:

1. Place two fingers on spring-loaded release, and pull release away from spindle/gear.
2. Open tie-down to a flat, 180° position.

NOTICE

Spring-loaded release should click into a notch on the painted handle. Both spring releases should clear the inner gear.

3. Pull line out. The inner spindle/gear should move freely.

To ratchet line or tighten down the strap on the boat:

1. Place two fingers on spring-loaded release, and pull release away from spindle/gear.

2. Bring both handles together. Both handles should ride on the inner gear.
3. Open (to approximately 110°) and close handles to ratchet. Leave in closed position to maintain pressure on line.

S - 3 OPERATION

A. Hitching Trailer

Before towing, the trailer must be properly hitched to the tow vehicle.



WARNING

To ensure proper engagement of the actuator's coupler to the tow ball, **DO NOT** use a multi-piece ball, an incorrectly sized ball, or a worn/damaged ball. **Four Winns® 214 CFS IO & OB trailers require a two inch (2") diameter tow ball. A two & five-sixteenths (2 5/16") diameter tow ball is required for the 234/254 CFS trailers.**

1. Position actuator ball socket above ball hitch.
2. Lift up on release handle fully (approximately 30° for a trailer with brake actuator and coupler assembly) to allow the ball latch to rotate open. The handle will remain up to indicate that it is not yet attached to the ball. See Figure S6.
3. Lower trailer tongue until ball is seated or rests in ball socket.
4. Close release handle. If it is a trailer with brake actuator and coupler assembly the handle will snap to its closed position when properly seated.

The release handle will close freely with finger pressure when ball is properly seated in socket. **If the handle does not close freely or does not snap to its closed position properly, do not tow trailer. DO NOT** force handle into closed position, otherwise damage could result. Inspect actuator for bent parts or cause of improper operation.

NOTICE

Keep the coupler clean and lubricated to prevent damage to the coupler.

5. Make sure the actuator is secure. If unsure, extend the trailer tongue jack to the ground and lift (with the jack) the car and trailer combination approximately 2" to 4". If the ball does not disengage and remains secured, the actuator is latched properly.

NOTICE

To prevent back injury, **DO NOT PHYSICALLY LIFT** the trailer tongue when loaded.

6. The locking pin, provided with the trailer, or a padlock **must be inserted** in the locking lever hole. This ensures the the coupler's locking lever remains in the locked position during towing of the trailer. Use of a padlock will help to deter theft.
7. Connect break-away cable S-hook securely to one of the tow vehicle hitch's safety chain connection points. The cable should hang clear of trailer tongue and be long enough to permit short radius turns without pulling break-away cable forward. **DO NOT** loop the break-away cable around a bracket and loop it back onto itself.
8. Make sure the break-away lever is fully rotated to the rear with the break-away catch pin securely located under the break-away spring. The break-away catch pin will be in the lever's uppermost notch. See Figure S12.

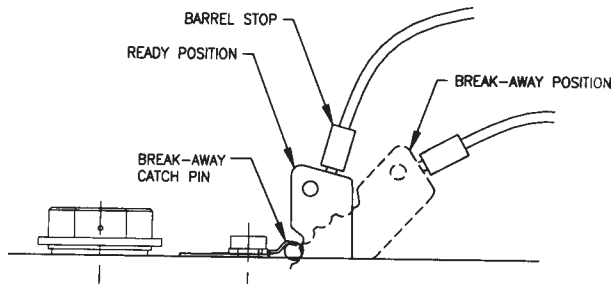

Figure S12: Break-away Cable



CAUTION

The Break-away system is not designed to operate if the trailer does not separate completely from the tow vehicle, or if the trailer tongue "submarines" and goes beneath the tow vehicle. **DO NOT** use break-away cable as a parking brake.

- Safety chains are provided and must be used. Cross the safety chains under the coupling and attach to the towing vehicle's frame or bumper. See Figure S13. Always allow slack for turns. Four Winns® provides securement clips for the safety chain hooks and recommends you use them. Regulations vary from state to state. Please check the local laws in your state.

WARNING

The trailer safety chains' length **MUST** be set short enough so the actuator's break-away cable is **NOT** pulled if the coupler separates from the tow vehicle's hitch but remains connected by the safety chains. The break-away system should only be activated after **BOTH** the trailer's coupler and safety chains have failed and allowed the trailer to completely separate from the tow vehicle. Provide just enough slack in the trailer safety chains to allow short radius turns. The chains should not drag on the ground. **Safety chains must be used.**

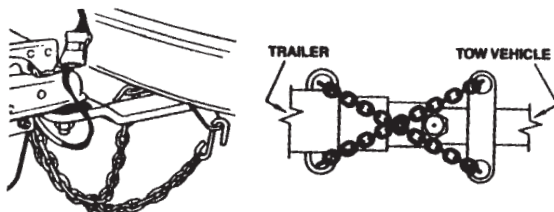

Figure S13: Crossing the Safety Chains

WARNING

To reduce the risk of Break-away accidents, be sure coupler is seated and safety chains criss-crossed before trailering.

NOTICE

Rubber safety chain straps are included on the "S" hooks to prevent chains from bouncing off of the tow vehicle and **must be used.**

- Retract jack fully and place in trailering or horizontal position.

WARNING

Be sure the tow vehicle and trailer are level and have a positive tongue load. This will allow the brake actuators to function properly on trailer models having such braking systems.

Be sure to read the manufacturer's literature, included in the owner's packet, before towing your Four Winns® boat and trailer.

B. Backing Up With Surge Disc Brakes

Follow the steps listed above for hitching the trailer before backing up.

- Before backing up a slope or through soft ground, pull the trailer forward slightly to assure the actuator socket is in the fully forward position.
- Back the trailer up.

CAUTION

Avoid sharp turns. This could bend, create extreme stress or fracture either the actuator or trailer tongue.

NOTICE

Be sure to check for obstacles or persons behind the trailer before backing up. Also, adjust your mirrors for clear view of the area behind the trailer.

- If the trailer is to be uncoupled from the tow vehicle after backing, block all trailer wheels and pull forward slightly to take strain off the actuator.

Uncouple the actuator by lifting the release handle and raise the trailer tongue with the jack.

For most trailering conditions, the brake actuator will allow you to back up normally. However, if the coupler is not wired or if there is a failure the trailer can still be backed up by using the manual brake lockout.

To use your lockout, check that no force is being applied to the actuator. This is achieved by positioning the towing vehicle and the trailer on a flat service, or with the trailer downhill from the tow vehicle. Set the vehicle's parking brake.

Rotate the lockout assembly forward and up. See Figure S14. Then push it rearward, so the pin ends will rest in the notches in the sides of the outer case. The actuator is now "locked out" and will not apply any noticeable pressure to the trailer brakes as you back up. If you can not rotate the assembly forward enough to reach the notch, make sure the actuator's coupler case assembly is pulled fully forward out of the outer case.

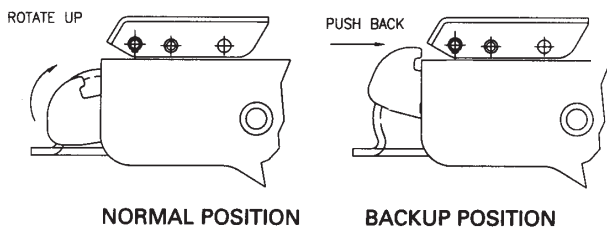

Figure S14: Brake Lockout Mechanism

NOTICE

Trailer components may be different between models and may change during the model year. Be sure to read all manufacturer's literature supplied with your Four Winns® trailer.

S - 4 TRAILERING

A. Checklist

Before trailering, the trailer should be inspected for the following:

1. Check tires for proper inflation. Under-inflated tires heat up rapidly and may blowout or cause uncontrolled swaying. Also, make sure lug nuts are tight.
2. Be sure the coupler is secured to the trailer hitch and safety chains are attached.
3. Be sure trailer taillights and turning signals are operational.
4. Check the brakes for proper operation prior to departure.

5. Check lug nuts for proper tightness.
6. Check tie-downs and make sure boat is secured to the trailer.
7. Check the springs and under carriage for loose parts.
8. Before towing, close and secure all hatches, doors, and windows. Securely store all equipment and canvas. Installed tops, side curtains, and aft curtains can be damaged while towing.
9. Carry a spare tire for both the trailer and towing vehicle. On extended trips, carry spare wheel bearings, seals, and races. Be sure and carry the proper tools to complete the repairs.

 **WARNING**

To avoid bearing failure and possible wheel loss, keep wheel bearings properly lubricated. Inspect the wheel bearings periodically and check for damage.

10. Before trailering, inspect the bearings for wear and adequate lubrication. When traveling, check the wheel hubs during stops at gas stations, restaurants or other places. If the hub feels abnormally hot, the bearing should be inspected before continuing the trip.

B. Tactics

NOTICE

Be sure to check the towing vehicle manufacturer's literature for recommendations on towing.

1. Install outside rear view mirrors on both sides of the towing vehicle to improve vision. Check the rear view mirrors at frequent intervals to be sure trailer and boat are riding smoothly.
2. Allow at least one car and trailer length between vehicles for each 10 mph. **DO NOT** tailgate.
3. Use low gear (on manual transmissions) when traveling up steep hills or over sand, gravel, or dirt roads.
4. Use care if shifting to a lower gear while traveling downhill. This could activate the trailer's surge brakes for the duration of the downhill run and cause overheating. Extended overheating could result in complete loss of the trailer brakes.

To help prevent overheating, slow down while approaching the crest of a hill and maintain a slow, controlled downhill speed. Apply brakes in short intervals to allow time between braking for the brakes to cool off.

5. When rounding turns on highways or streets, DO NOT cut corners. Also, travel slowly over railroad tracks.
6. If the trailer begins to “fishtail” when accelerating, reduce speed until it ceases. If the trailer “fishtails” again during acceleration, stop to investigate the cause of the problem. Check for improper trailer load and uneven weight distribution inside the boat. Check the winch line and tie-downs. Also check the tires for proper inflation or damage. If necessary, redistribute the load before continuing.

For additional information on trailering, refer to the “Boating Basics” manual included in the owner’s packet.

S - 5 MAINTENANCE

A. Care of Exterior Finish

When using the trailer, keep in mind the paint can scratch and become marred during normal use. In most cases, touch-up paint can be ordered. Please contact a Four Winns® dealer for assistance.

Some maintenance is required to maintain the finish and minimize rusting. The trailer should be washed and rinsed with clean water immediately after each use. On galvanized trailers, rinse only with clean water. Depending upon use, waxing is recommended twice a year. Use paste wax designed for enamel paint.

B. Bunks

The bunks should be replaced if they are cracked, warped, or evidence of dry-rot is found. The replacement boards should be treated lumber of the same length and width.



CAUTION

DO NOT burn damaged or broken bunks. Toxic fumes will be released. Dispose of bunks properly.

C. Swivel Jack

Keep the swivel jack clean of dirt, tar, and mud. Lubricate every six months. The swivel jack’s inner ram should be lubricated with SAE 30 weight oil. The top cover may be removed to lubricate the gears with wheel bearing grease.

Replace all worn and damaged parts. ALWAYS use the manufacturer’s replacement parts. Replacement parts may be ordered through your Four Winns® dealer.

For more information on maintenance, refer to the manufacturer’s literature included in the owner’s packet.

D. Brake Actuator & Coupling Assembly

When storing or parking your trailer, keep the brake actuator and coupling assembly (coupler) off the ground to prevent dirt buildup in the ball socket. Keep the coupler clean of dirt, tar, and mud. Lubricate the coupler with SAE 30 weight oil every six months or as often as necessary. Replace any worn or defective parts. If the coupler is damaged, contact your Four Winns® dealer for replacement parts. DO NOT use a damaged or bent coupler assembly.

For more information on maintenance, refer to the manufacturer’s literature included in the owner’s packet.

NOTICE

The trailer should be set up at a slight angle to allow for water to drain aft in the boat.

E. Winch

The winch should be kept clean of dirt, ice, paint, etc., and the spur gears should have a film of grease on them at all times. Apply several drops of SAE 30 weight oil to the ratchet pawl mechanism, bushings and pinion shaft threads twice per season.

Replace any worn or damaged parts. For more information on maintenance, refer to the manufacturer’s literature included in the owner’s packet.

F. Lights

Inspect wiring for cuts or bare wire which could cause electrical shorts. Repair or replace defective wiring. Replace cracked or damaged lens and always carry spare bulbs. Replacement parts may be ordered through a Four Winns® dealer.

G. Tie-downs

Replace frayed or damaged tie-downs. Periodically, lubricate the ratchet mechanism with a fine oil or silicone spray. Replacement parts may be ordered through a Four Winns® dealer.

H. Wheels

Some maintenance is required to maintain the finish and retard rusting of painted rims. The wheels should be cleaned with dishwashing soap and water and rinsed with clean water immediately after each use. Waxing is recommended three to four times each year.

Aluminum wheel rims may be cleaned with dishwashing soap and water. However, cleaning products specifically for aluminum are available and can be used. Cleaners may be obtained from Four Winns® dealers and your local auto parts stores. The Mag wheel manufacturer recommends a product by Priority One® called Pro-Long Aluminum/Chrome Wheel Protectant™. Galvanized rims should be rinsed only with clean water immediately after each use.

NOTICE

ALWAYS read the manufacturer's instructions on the label before using any product.

I. Brakes

Keep the actuator clean of dirt, tar, and mud. The actuator and internal parts should be lubricated at all times with SAE 30 weight oil. The hitch ball may be lubricated with automotive grease or lubricant made for hitch balls.

Periodically inspect the brake system for leaks. Check all hoses for cuts or wear. Replace all defective hoses. The master cylinder should be filled within 1/2 inch from the top of the reservoir.

At the beginning of each year, inspect the brakes for excessive wear, have linings replaced if necessary.

If the brakes need bleeding, consult your Four Winns® dealer for assistance. If unavailable, a brake or auto repair facility can perform the repair.

Refer to the manufacturer's literature included in the owner's packet for additional information on the brake system.

J. Bearings

Wheel bearings and seals should be inspected at the same time as brakes. Have worn or defective parts replaced. Grease bearings and seals at this time and at the end of the boating season. Bearing Protectors should be greased three to four times a year. A grease fitting is provided.

Four Winns® uses the Accu-Lube™ bearing protection system on its trailers. The Accu-Lube™ design is submersible and provides for grease flow that completely repacks and protects the bearings. This lubrication system disallows water entry, thus extending the life of the bearings, spindle and hub.

Lubricate the bearings as follows:

1. Remove the rubber plug.
2. Insert the grease gun into the grease fitting. Pump grease until old grease comes back out the front.
3. Remove old grease and reinstall rubber plug.

NOTICE

Most bearing failures are due to improper maintenance. Be sure to inspect bearings and seals as noted in Section S-6B and refer to the manufacturer's literature included with your trailer.

S - 6 AXLE INSPECTION & REPAIRS

As a general rule, repairs and maintenance should be performed by qualified servicing personnel. Our axle manufacturer recommends that a certified mechanic should be consulted on the following items:

1. Broken axle
2. Broken spring
3. Worn spring eye bushing parts
4. Sagging springs
5. Welding fatigue
6. Serious leakage of seal
7. Tire wear
8. Loose or worn suspension parts
9. All brake related adjustments, inspections and problems

A. Removal of Hub

The following instructions pertain only to trailers manufactured by Four Winns®. To remove the hub to inspect the bearings and seals, refer to Figure S15 and the following instructions:

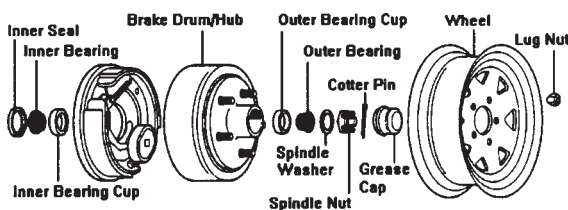

Figure S15: Axle Components

1. Remove lug nuts.
2. Remove wheel.
3. Remove grease cap.
4. Remove cotter pin.
5. Unscrew the spindle nut counter clockwise.
6. Remove spindle washer.
7. Remove hub from spindle.

B. Bearing/Seal Inspection and Replacement

When inspecting bearings or seals:

1. Inspect the grease seal for damage, tears, or cracks. If there is no damage or leakage in not occurring, the seal is in good condition.

If the seal is torn or cracked, then it should be replaced. The seal can be pried out of the hub with a screw driver. Be sure to replace the seal using the recommended replacement parts. Parts can be obtained from your Four Winns® dealer.

2. When inspecting the bearing, check for corrosion and wear. If any rust or wear exists on the bearing, then remove and replace with the recommended parts listed in the table above.

3. If the bearings are in good condition, repacking the grease should be done at this time. Hand pack each bearing individually using a premium water resistant wheel bearing grease.

C. Hub Reinstallation

1. To reinstall hub, reverse the procedures listed above.
2. It is important to tighten the spindle nut to approximately 50 ft. lbs. (12" wrench with full hand force). Loosen the nut then finger tighten.
3. Replace the cotter.
4. When reinstalling wheel, the following tightening procedure is recommended by the manufacturer:
 - a. Place wheel lug nuts on by hand to start.
 - b. Tighten initially to 15 - 20 ft. lbs. (Apply 20 pounds of pressure to wrench 12" long) using cross tightening sequence. Proceed to finish tightening to 85 ft. lbs. (Applying 85 pounds of pressure to wrench 12" long will yield 85 ft. lbs. of torque).
 - c. Re-torque after first 50 miles of use.

Refer to Section S-2G for additional information on wheel requirements.

GLOSSARY

ABAFT - Toward the rear of a boat.

ABEAM - At right angles to the keel of the boat.

ABOARD - On the boat.

ABREAST - Side by side.

ADRIFT - Loose, not on moorings or towline.

AFT - Moving toward the stern, you are going aft.

AGROUND - Stuck fast to the bottom.

AHEAD - In a forward direction.

ALEE - Away from the direction of the wind; opposite of windward.

ALOFT - Above the deck.

AMIDSHIPS - 1. An object or area midway between the bow and stern. 2. An object or area midway between the port side and the starboard side of a vessel.

AMPERE - The standard unit used to measure the draw of an electrical current.

ANCHOR RODE OR ROPE - The line (chain) connecting a vessel to its anchor.

ANCHOR BALL - A black, circular, day signal hoisted to show that a vessel is anchored. Replaced at dusk by the anchor light.

ASTERN - Anywhere behind the boat, a reverse direction, opposite of ahead.

ATHWARTSHIPS - A line, or anything else, running perpendicular to the fore-and-aft center line of a boat.

BATTEN - A strip of wood or metal used to secure tarpaulin(s) in place over a hatch. To batten down means to secure for rough weather.

BEAM - 1. The widest distance across a boat from the outside skin on one side to the outside skin on the other. 2. A transverse structural member that stiffens and supports a portion of the deck.

BEAM WIND - A wind blowing against the side of the vessel, perpendicular to the long axis of the vessel.

BILGE - The lowest interior area of a hull, used to collect water that has entered.

BILGE PUMP - A pump intended for removal of spray, rainwater, and the normal accumulation of water due to seepage and spillage; not intended for damage control.

BINNACLE - The stand or support for a magnetic compass occasionally used to mean helm.

BITT - A heavy and firmly mounted piece of wood or metal used for securing lines.

BLOCK - A wooden or metal case enclosing one or more pulleys and having a hook, eye, or strap by which it may be attached.

BOLLARD - A single post (wood, metal, or concrete) on a dock, pier, or wharf used to secure a vessel's lines.

BONDING - The electrical connection of exposed metallic, non-current carrying components to a common point on the main engine block.

BOW - The front end of the boat.

BOW LINE - A docking line leading from the bow.

BREAKER - A single breaking, plunging or spilling wave.

BREAKER LINE - The outer limit of the surf. However, all breakers may not be in a line. They can occur outside the breaker line.

BRIDGE - The main vessel control station.

BROACH - The turning of a boat parallel to the waves, subjecting it to possible capsizing.

BULKHEADS - The interior walls of a boat.

BULWARK - The side of a vessel when carried above the level of the deck.

BUOY - An anchored float used for marking a position on the water, a hazard, or a shoal.

CAPSIZE - To turn over.

CAPSTAN - A machine that moves a cylindrical device on a shaft for the purpose of hauling up an anchor.

CAST OFF - To let go.

CATAMARAN - A twin-hulled boat, with the hulls being side-by-side.

CHINE - The intersection of a boat's bottom and side. If this intersection is rounded, it is a "soft" chine. If the intersection is squared off, it is a "hard" chine.

CHOCK - 1. A fitting or hole in a railing or deck through which a mooring or anchor line is routed. 2. A wedge used to secure an item in place.

CIRCUIT BREAKER - A device used to interrupt an electrical circuit when current flow exceeds a predetermined level.

CLEAT - A double-ended deck fitting to which lines are secured; usually anvil-shaped.

COAMINGS - Raised lips around cockpits or hatches used to keep water from entering

COCKPIT - An exposed deck area (usually aft) that is substantially lower than the adjacent deck.

COMBER - A wave on the point of breaking. A comber has a thin line of white water on its crest, known as "feathering."

COMPANIONWAY - The steps or ladder leading downward from a deck.

COMPARTMENTS - Rooms divided by bulkheads.

COUNTER - The overhang at the stern of a boat.

CRADLE - A framework, generally made of wood, used to support a boat when it is out of the water.

CREST - The top of a wave, breaker or swell.

CUDDY - A small sheltered cabin in a boat.

CURRENT -1. The movement of water, 2. The flow of electrical charge.

DEAD AHEAD - Directly in front of the boat.

DEAD RECKONING - A plot of courses steered and distances traveled through the water.

DECK - A permanent covering over a compartment, hull or any part thereof.

DINGHY - A small, open boat used for ship to shore transportation.

DISPLACEMENT - The weight of water displaced by the hull of a vessel.

DISPLACEMENT HULL - A hull that "displaces" a volume of water equal to the weight of the boat. A hull designed to run in the water rather than on top of the water. When a displacement hull moves through the water, it pushes that water out of the way. Water will then flow around the hull and fill the "hole" the boat leaves astern.

DOCUMENTED VESSEL - Documented yachts have been specially registered with the U.S. Coast Guard. All documented yachts must have their name and home (hailing) port marked on some conspicuous place on the hull. Numbering is not required. Advantages include legal authority to fly the yacht ensign, privilege of recording bills of sale, and other instruments of title with federal officials, and preferred status for mortgages. Documentation does not exempt the unit from any State or Federal taxes. All safety and equipment regulations still apply.

DOLPHIN - A group of piles driven close together and bound with wire cables into a single structure.

DRAFT - 1. The depth of a boat from the actual water line to the bottom of the lowest part of the boat (e.g., the propeller tip or rudder). 2. The depth of water necessary to float a boat.

DROGUE - Any device streamed astern to check a vessel's speed, or to keep its stern up to the waves in a following sea.

DYE MARKER - A brightly colored chemical that spreads when released into water; normally used to attract attention.

EBB TIDE - A receding tide.

EVEN KEEL - To be floating evenly without listing to either side.

EXHAUST SYSTEM - The means by which the hot engine (or generator) exhaust gases are moved from the engine to an outboard port and then released into atmosphere.

EYE SPLICE - A permanent loop spliced in the end of a line.

FAST - Said of an object that is secured to another.

FATHOM - Six feet.

FENDER - A device (usually constructed of rubber or plastic) positioned so as to absorb the impact between vessels or dock.

FETCH - The unobstructed distance that the wind can blow over the water to create waves.

FLARE - 1. Outboard curve of the hull as it comes up the side from the waterline; the reverse of tumble home. 2. A pyrotechnic device used for emergency signaling.

FLAT - A small deck that is built below decks, specifically to support a piece of equipment.

FLEMISH - To coil down a line or rope on deck in a flat, circular, concentric arrangement.

FLOTSAM - Floating wreckage, trash or debris.

FLUKE - The palm of an anchor.

FOAM CREST - The top of the foaming water that speeds toward the beach after a wave has broken, commonly referred to as "white water."

FOLLOWING SEA - A sea (waves) moving in the same direction as a vessel.

FORE-AND-AFT - A line, or anything else, that runs parallel to the longitudinal center line of a boat.

FOREFOOT - The portion of a vessel's keel that curves upward to meet the stem.

FOREPEAK - A compartment in the bow of a boat.

FORWARD - Toward the bow.

FREEBOARD - The minimum vertical distance from the surface of the water to the gunwale.

FREQUENCY - The number of crests passing a fixed point at a given time.

FRONTS - Where opposing warm and cold air masses meet, generally producing a band of wet, stormy weather wherever they meet.

GALLEY - The kitchen area of a boat.

GALVANIC CORROSION - A potential electrical difference exists between dissimilar metals immersed in a conductive solution (e.g., salt water). If these metals touch or are otherwise electrically connected, this potential difference produces an electron flow between them. The attack on the less corrosion resistant metal is usually increased and the attack on the more resistant metal is decreased, as compared to when these metals are not touching.

GANGWAY - The area of a ship's side where people board and disembark.

GASKET - A strip of sealing material, usually rubber, set along the edge of a water or gas tight door, port, cover or hatch.

GELCOAT - The thin outer layer of pigmented plastic covering a fiberglass vessel.

GLAND - The movable part of a stuffing box, which when tightened, compresses the packing.

GROUND - Electrical term meaning the electrical potential of the earth's surface, which is zero.

GROUND SPEED - A vessel's speed made good over the earth's surface along a course or track.

GROUND TACKLE - The anchor, anchor rodes, and other fittings that are used to secure a vessel at anchor or dockside.

GUNWALE - 1. The line where the upper deck and the hull meet. 2. The upper edge of a boat's side.

HALYARD - A line used to hoist a flag or pennant.

HATCHES - Cover on hatchways.

HATCHWAYS - Access ways through decks.

HARDTOP - A permanent cover over the cabin or cockpit.

HAWSER - A heavy rope or cable used for mooring or towing.

HEAD - A toilet or lavatory area.

HEADING - The direction that a vessel is going with reference to true, magnetic, or compass north.

HEADWAY - The forward motion of a vessel through the water.

HEAVE TO - To bring a vessel up in a position where it will maintain little or no headway, usually with the bow into the wind.

HEAVY WEATHER - Stormy weather with high seas and strong winds.

HEEL - To tip to one side.

HELM - The wheel or tiller that manually controls the boat's steering system.

HELMSMAN - The individual steering the vessel.

HIGHS - A center of pressure surrounded by lower pressure on all sides. Caused by a mass of cooler, sinking, drier air. This raises the area ground level air pressure and provides clear skies.

HULL - The main body of a boat.

INBOARD - 1. From either the port or starboard side of a boat toward the fore-and-aft centerline of a boat. 2. The dock side of a moored boat.

INLAND RULES - Nautical "Rules-of-the-Road" that apply in U.S. lakes, rivers, and coastal waters.

INTERNATIONAL RULES - Nautical "Rules-of-the-Road" that are in effect by international agreement to the high seas.

ISOBARS - Lines of equal air pressure that connect all the local points on a weather map. These lines are usually closed and define high or low pressure air masses.

ISOTHERMS - Isotherms are lines that are similar to isobars except that isotherms connect all the points that are of equal temperature.

JETSAM - Refuse that sinks when discharged overboard.

KEDGE(S) - One or more anchors set out from a grounded vessel, usually astern, to 1) keep it from being driven further aground and 2) to aid in refloating.

KEEL - 1. The centerline of a boat hull bottom running fore and aft, 2. The backbone of a vessel.

KNOT - 1. A maritime unit of speed equal to one nautical mile per hour (6076 feet). 2. A term for hitches and bends.

LANYARD - A short line made fast to an object to secure it.

LATITUDE - The measure of angular distance in degrees, minutes, and seconds, north or south of the equator.

LAZARETTE - Storage compartment in the deck at the stern.

LEADLINE - A weighted line used to take depth measurements.

LEE - The direction opposite that of the wind.

LEEWARD - Away from the wind.

LIST - A vessel that inclines to port or starboard.

LORAN - Long Range Navigation. An electronic system whereby a navigator can determine position regardless of weather.

LONGITUDINAL - Running lengthwise.

LOWS - A region of low atmospheric pressure. Hurricanes are extremely concentrated low pressure systems.

LUBBER LINE - A mark or line on the compass parallel to the keel indicating forward.

MAST - A spar that is set upright to support lighting, rigging, or sails.

MOORING - An arrangement for securing a boat to a mooring buoy or pier.

NAVIGATION LIGHTS - A set of red and green or white lights which must be shown by all vessels between dusk and dawn.

OVERHEAD - A ceiling or roof of a vessel.

OVERBOARD - Over the side of the boat.

OUTBOARD - 1. From the fore-and-aft centerline of a boat toward both the port and starboard sides. 2. The seaward side of a moored boat. 3. An engine that is mounted externally onto the transom of a boat.

PAINTER - A line to the bow of a small boat used for making fast.

PASSAGEWAY - A corridor or hallway aboard ship.

PENNANT - The line by which a boat is made fast to a mooring buoy; also pendant.

PERSONAL FLOATATION DEVICE (PFD) - A life preserver.

PIER - A loading platform that extends at an angle from the shore.

PILASTER - A rectangular structural support column that is an extension of the port and starboard aft cabin sides and which supports the hardtop and flybridge.

PILING - Support, or protection for wharves, piers, etc.

PITCH - 1. The vertical (up and down) motion of a bow in a seaway, about the athwartships axis. 2. The axial advance of a propeller during one complete revolution.

PITCHPOLING - A boat being thrown end-over-end.

PLANING HULL - At slow speeds, a planing hull will displace water in the same manner as a displacement hull. As speed is increased, the hull provides a lifting effect up onto the surface of the water.

POINT - One of 32 points of the compass that is equal to 11-1/4 degrees.

PORT - 1. Looking forward, the left side of a boat, 2. A harbor, 3. An opening for light or ventilation or passage of material in the side of a boat.

PORT BEAM - The left-center of a boat.

PORT BOW - Facing the bow, the front left side.

PORT QUARTER - Looking forward, a vessel's left rear section.

QUARTER - The sides of a boat aft of amidships.

QUARTERING SEA - Sea coming on a boat's quarter.

RED-RIGHT-RETURNING - A term for helmsmen that buoys and day markers are on the right when returning from seaward.

REEF - A shallow underwater barrier.

REEVE - To pass a line through a block or other opening.

RIDGES - High pressure fingers extending out from a high.

RODE - The anchor line or chain.

RUNNING LIGHTS - Lights required to be shown on boats underway between sundown and sunup.

RUDDER - A vertical plate for steering a boat.

SALON - The main social cabin on a vessel, usually the largest area, occasionally referred to as the deckhouse.

SCREW - A propeller.

SCUPPER - A drain from the edge of a deck that discharges overboard.

SEACOCK - A positive action shut-off valve connected directly to the hull seawater intake and discharge piping.

SERIES - A group of waves which seem to travel together and at about the same speed.

SHACKLE - A "U" shaped connector with a pin or bolt across the open end.

SHAFT - The long, round member that connects the engine or transmission to the propeller.

SHAFT LOG - A fitting at the hull bottom where the shaft connecting an engine to its propeller penetrates the hull. A shaft log permits the shaft to rotate while simultaneously preventing water from entering the hull.

SHEER - The top of the hull's curvature at the deck line from the bow to the stern.

SHEER STRAKE - The upper edge of the hull, immediately below the deck.

SHEET BEND - A knot used to join tow ropes.

SHOAL - An area of shallow water.

SILENCER - A baffled chamber installed in an exhaust system to reduce the noise.

SOLE - Term for deck, cabin or cockpit floor.

SPAR - A general term for booms, masts, yards etc.

SPRING LINE - A pivot line used in docking, undocking, or to prevent the boat from moving forward or astern while made fast to a dock.

STARBOARD - Looking forward, the right side of a boat.

STARBOARD BEAM - The right-center of a boat.

STARBOARD BOW - When facing the bow, the front right side.

STARBOARD QUARTER - When looking forward, the right rear section of the boat.

STEERAGEWAY - The lowest speed at which a vessel can be controlled by the steering wheel.

STEM - The leading edge of a boat's hull.

STERN - The back of a boat.

STRINGER - A fore and aft continuous member used to provide a vessel longitudinal strength.

STRUT - A propeller shaft support that is below the hull.

SUMP - A pit or well into which water is drained.

SUPERSTRUCTURE - Deck houses and other structures extending above the deck.

THWART - A seat or brace running laterally across a boat.

THWARTSHIPS - At right angles to the centerline.

TILLER - A bar or handle for turning a boat's rudder, or motor.

TOPSIDE - To go up to the top deck.

TRANSOM - The stern cross-section of a square sterned boat.

TRANSVERSE - Across the vessel; athwartships.

TRIM - Fore and aft balance of a boat.

TROUGH - 1. The valley that exists between waves. 2. A trough is the opposite of a ridge in that it is an elongated low-pressure area extending out from a low. A trough normally indicates unsettled weather.

TUMBLE HOME - The opposite of flare. The shape of the hull as it moves outboard going down from the gunwale to the waterline or chine.

UNDERWAY - Movement. Usually referring to a vessel proceeding forward.

V-BOTTOM - A hull with the bottom section in the shape of a "V."

V DRIVE - A drive system that has the output of the engine facing forward and coupled to a transmission. The prop shaft is then coupled to the transmission.

WAKE - Moving waves, track or path that a boat leaves behind it when moving across the water.

WATER LINE - The line of the water on the hull when the vessel is afloat.

WATCH - A 4 hour duty period while at sea.

WAVES - Waves are periodic disturbances of the sea's surface, caused by wind, seaquakes, and the gravitational pull of the moon and the sun.

WAVE GRADIENT - A wave's slope or angle from trough to crest with respect to the horizon.

WAVE HEIGHT - From the bottom of a wave's trough to the top of the crest.

WEATHER DECK - A deck with no overhead protection.

WET EXHAUST - This term refers to an exhaust system where the cooling seawater is mixed with the exhaust gases just after the riser. This mixture is then ejected through the drive or ports located in the transom or hull sides.

WHARF - A man-made structure bounding the edge of a dock and built along the shoreline.

WHIPPING - The act of wrapping the end of a piece of rope with small line, tape or plastic to prevent it from fraying.

WINDLASS - A device used to raise and lower the anchor.

WINDWARD - Toward the direction from which the wind is coming.

YAW - 1. To swing off course, as when due to the impact of a following or quartering sea. 2. Any motion about a vertical axis.

FLOAT PLAN

Copy this page and fill out before going boating. Leave the completed copy with a reliable person who can be depended upon to notify the Coast Guard, or other rescue organization, should you not return as scheduled. DO NOT file this plan with the Coast Guard.

Name _____ Telephone _____

Description of Boat _____ Type _____ Color _____ Trim _____

Registration Number _____

Length _____ Name _____ Make _____

Four Winns Hull Identification Number _____

Other Information _____

Persons Aboard: Name	Age	Address	Telephone

Engine Type _____ HP _____

Number of Engines _____ Fuel Capacity _____

Survival Equipment:

PFDs _____ Flares _____ Mirror _____

Smoke Signals _____ Flashlight _____ Food _____

Paddles _____ Water _____ Anchor _____

Raft or Dinghy _____ EPIRB _____ Sea Anchor _____

Navigation Equipment:

Compass _____ Loran _____ GPS _____ Radar _____

Radio: Yes _____ No _____ Type _____ Frequency _____

Phone: Yes _____ No _____ Phone Number _____

Destination _____ Estimated Time of Arrival _____

Expected to Return By _____

AutoType _____ License No. _____ Where _____

If not returned by _____ call the Coast Guard, or _____

Local Marine Authority

Coast Guard Telephone Number: _____

Local Marine Authority Telephone Number: _____

SERVICE INFORMATION

BOAT MODEL	
HULL IDENTIFICATION NUMBER	
ENGINE MODEL	
ENGINE SERIAL NUMBER	
DRIVE MODEL	
DRIVE SERIAL NUMBER	
PROPELLER DIAMETER	
PROPELLER PITCH	
PROPELLER PART NUMBER	
OIL FILTER NUMBER	
BOAT COLOR	
COCKPIT UPHOLSTERY COLOR	
CABIN UPHOLSTERY COLOR	
FUEL CAPACITY	
FUEL: ESTIMATED AVG. GALLON/HR USAGE	
IGNITION KEY NUMBER	
GLOVE BOX KEY NUMBER	
COMPANIONWAY KEY NUMBER	
TRAILER MODEL	
TRAILER COLOR	
TRAILER SERIAL NUMBER	
TRAILER TIRE SIZE & MANUFACTURER	
SELLING DEALER	
ADDRESS	
CITY & STATE	
PHONE NUMBER	
MISCELLANEOUS	

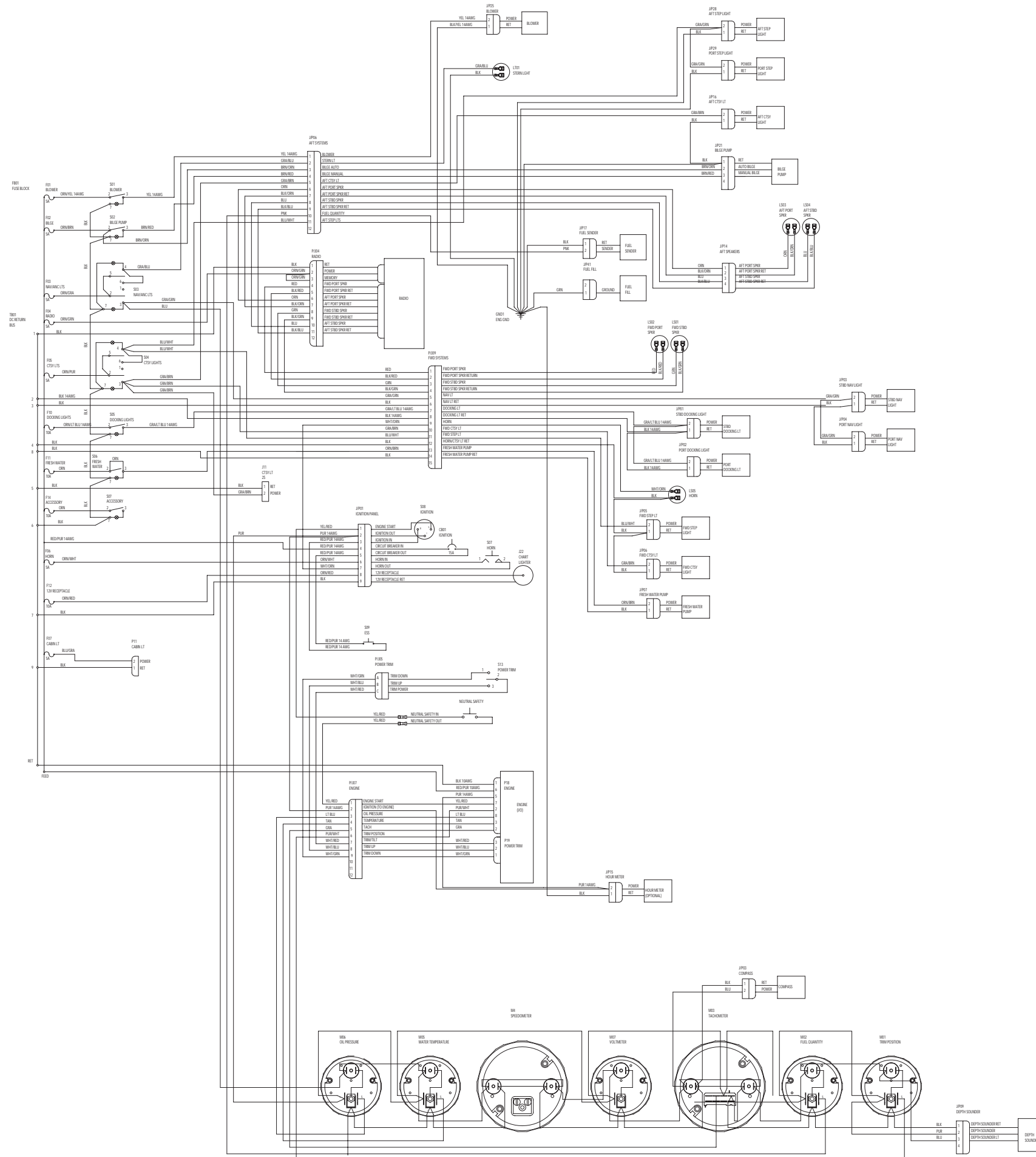

**WIRING DIAGRAM
CANDIA FS 214 I/O**

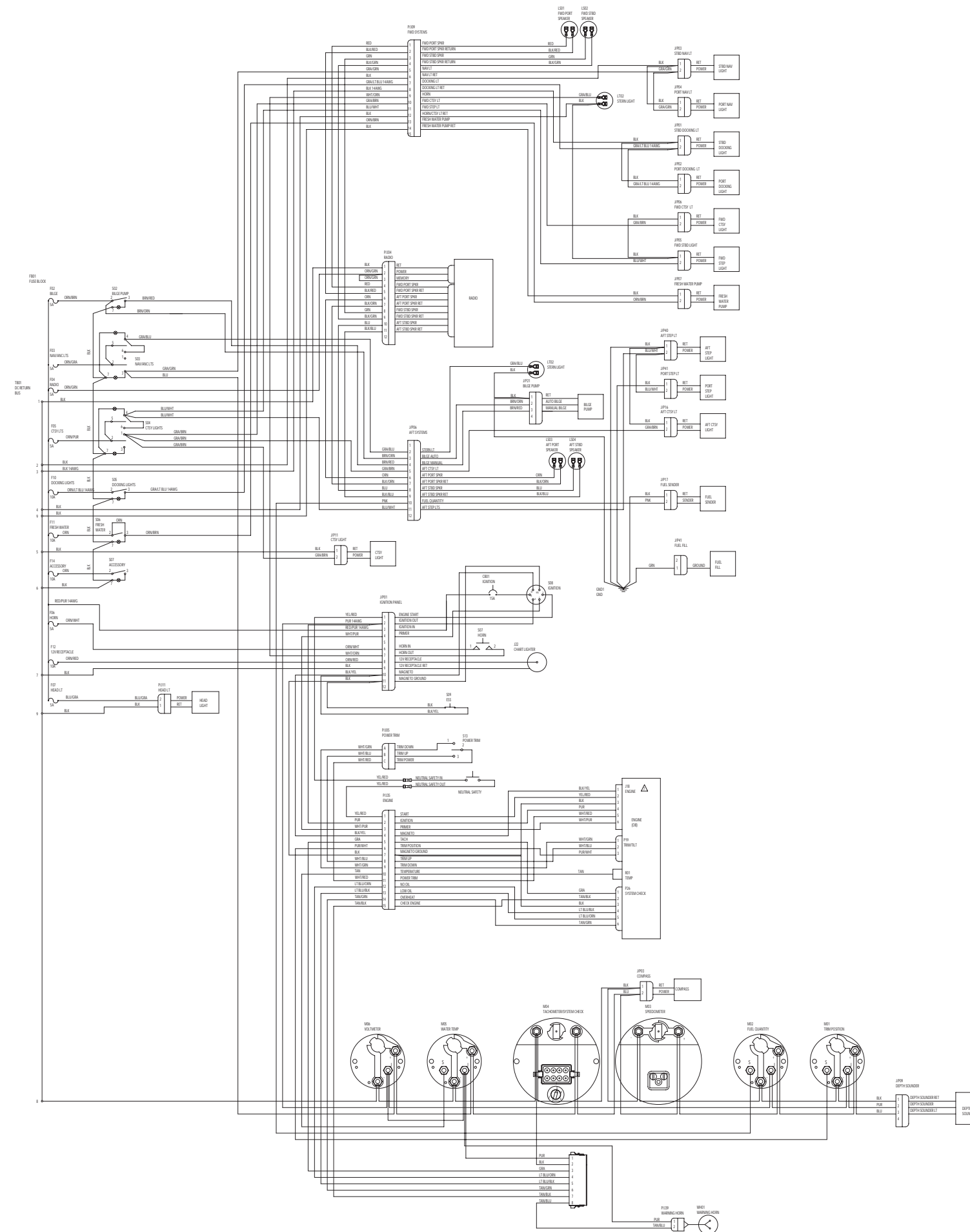



Part # 090-2559

Four Winns L.L.C.